

# INTERRA

*Developer of Uniqueness*

## LG/Beko/Arcelik Air Condition Units

### AC - KNX Gateway

### Product Manual

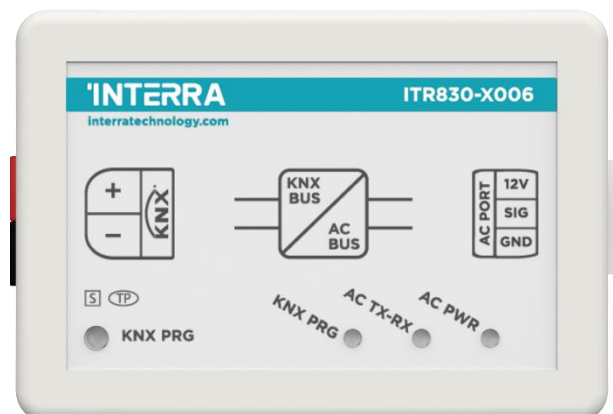

# Contents

- 1. Content of The Document** ..... 5
- 2. Product Description**..... 6
  - 2.1. Technical Information..... 7
  - 2.2. Dimensions ..... 8
  - 2.3. Connection Diagram & Features..... 10
- 3. ETS Parameters & Descriptions**..... 13
  - 3.1. General Page ..... 14
    - 3.1.1. Parameters List ..... 15
  - 3.2. Logic Gate ..... 18
    - 3.2.1. Parameters List ..... 20
  - 3.3. Converter ..... 22
    - 3.3.1. Parameters List ..... 24
  - 3.4. Operating Mode ..... 27
    - 3.4.1. Parameters List ..... 30
  - 3.5. Fan Speed ..... 32
    - 3.5.1. Parameters List ..... 34
  - 3.6. Air Deflectors ..... 36
    - 3.6.1. Parameters List ..... 38
  - 3.7. Temperature ..... 39
    - 3.7.1. Parameters List ..... 41
  - 3.8. Scenes ..... 43
    - 3.8.1. Parameters List ..... 44
  - 3.9. Special ..... 45
    - 3.9.1. Parameters List ..... 47
- 4. ETS Objects List & Descriptions** ..... 50
  - 4.1. General Objects ..... 54
  - 4.2. Logic Gate Objects ..... 56
  - 4.3. Converter Objects ..... 57
  - 4.4. Operating Mode Objects ..... 58
  - 4.5. Fan Group Objects..... 62
  - 4.6. Temperature Group Objects ..... 66
  - 4.7. Air Deflectors Group Objects ..... 68
  - 4.8. Scene Group Objects ..... 69
  - 4.9. Special Group Objects ..... 70
- Appendix**..... 73

Information contained in this publication regarding device applications and the like is provided only for your convenience and may be superseded versions by updates. It is your responsibility to ensure that your application meets your specifications.

INTERRA MAKES NO REPRESENTATIONS OR WARRANTIES OF ANY KIND WHETHER EXPRESS OR IMPLIED, WRITTEN OR ORAL, STATUTORY OR NONSTATUTORY, RELATED TO THE INFORMATION INCLUDING BUT NOT LIMITED TO ITS CONDITION, QUALITY, PERFORMANCE, MERCHANTABILITY OR FITNESS FOR PURPOSE.

Interra disclaims all liability arising from this information and its use. Use of Interra devices in life support and/or safety applications is entirely at the buyer's risk, and the buyer agrees to defend, indemnify and hold harmless Interra from any damages, claims, suits, or expenses resulting from such use. No licenses are conveyed, implicitly or otherwise under any Interra intellectual rights.

## Trademarks

The Interra name and logo and the Interra ITR830-X006 LG/Beko/Arcelik AC – KNX Gateway devices are registered trademarks of Interra Technology in Türkiye and other countries.

All other trademarks mentioned herein are property of Interra Technology.

©2025, Interra, Printed in Turkiye, All Rights Reserved.



Printed on recycled paper.

**TS EN ISO 9001:2008**

---

## TO OUR CUSTOMERS

---

One of our most important aims is to provide you with the best documentation possible to successfully use your Interra products. Focusing on this, we will keep on improving our documentation to better suit your needs. Our publications will be updated as new volumes are introduced as soon as changes are made.

If you have any questions or comments regarding this publication, do not hesitate to contact us:

E-mail: [info@interra.com.tr](mailto:info@interra.com.tr)

Tel: +90 (216) 326 26 40 Fax: +90 (216) 324 25 03

### Most Current Product Manual

To obtain the most up-to-date version of this product manual, please visit our Web site at:

<http://www.interratechnology.com>

You can determine the version of an Interra document by examining its literature number found on the bottom right corner of any page.

The first two letters of the literature are the type of document. The numbers that follow are the creation date of the document and the last letter is the version (e.g., PM181017001A is the version A of a product manual created on the date 17/10/18).

## 1. Content of The Document

This document contains Interra brandmark's ITR830-X006 LG/Beko/Arcelik AC - KNX Gateway coded devices' electronic and all essential feature information for programming these products. In each subtitle is explained the characteristics of the device. Modifications of the product and special change requests are only allowed in coordination with product management.

## 2. Product Description

ITR830-X006 is an air conditioner gateway used for monitoring and controlling all the functioning parameters of LG/Beko/Arcelik air conditioners via the KNX bus line. LG/Beko/Arcelik AC - KNX Gateway is compatible with models in VRV types categorized in the compatibility list sold by LG/Beko/Arcelik.

LG/Beko/Arcelik AC - KNX Gateway has an easy installation feature and can be installed inside the own AC indoor unit or a proper location away from the air conditioner, it connects one side directly to the electronic circuit of the AC indoor unit and in the other side directly to the KNX bus so, LG/Beko/Arcelik Gateway provides bidirectional communication between KNX and AC bus.

- 12V/SIG/GND bus connections can be made up to 50 meters away. The bus terminal connects the AC indoor unit and the wired remote controller.
- Up to 5 different modes are available to determine the operating mode such as; auto, heat, cool, fan, dry.
- ITR830-X006 have 4 logic gates to carry out logic functions with 3 different gate types such as AND, OR & XOR.
- ITR830-X006 have 8 converter gates with 1 input and 1 output. Each input has 8 different data types and each output has 4 different outputs.
- Up to 5 scenes can be saved and executed from KNX, fixing the desired combination of ON/OFF, Operation Mode, Setpoint Temperature, Fan Level control, Vane Position control and Remote Controller Lock at any moment by using a simple switching with KNX bus telegram.
- LG/Beko/Arcelik type AC Indoor unit can be controlled simultaneously by the remote controller of the AC unit and LG/Beko/Arcelik Gateway.
- LG/Beko/Arcelik indoor unit monitoring from KNX, including monitoring of AC unit's state of internal variables, running working hours counter (E.g., for filter maintenance control), and error indication and error code.
- Control of the AC unit based on the ambient temperature read by the own AC unit, or in the ambient temperature read by any KNX thermostat.
- Special functions for high-level monitoring; window contact, working hours counter, standby and timer function.

## 2.1. Technical Information

The following table shows the technical information of the LG/Beko/Arcelik Gateway.

<b>Product Code</b>	<b>ITR830-X006</b>
<b>Power Supply</b>	KNX Power Supply
<b>Current Consumption</b>	5 mA
<b>Push Buttons</b>	1 x KNX Programming Button
<b>LED Indicators</b>	1 x KNX Programming LED
<b>Type of Protection</b>	IP 20
<b>Cable Distance</b>	Max 50 m
<b>Mode of Commissioning</b>	S-Mode
<b>Temperature Range</b>	Operation (0°C...40°C) Storage (-10°C...70°C)
<b>Maximum Air Humidity</b>	< 90 RH
<b>Colour</b>	Light Grey
<b>Dimensions</b>	50 x 35 x 15 mm (W x H x D)
<b>Certification</b>	KNX Certified
<b>Configuration</b>	Configuration with ETS

## 2.2. Models and Variations

ITR830-X006

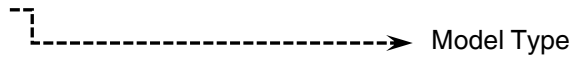

X: Model Type	
1	LG
2	Beko
3	Arcelik

**Table 1:** ITR830-X006 Model Type Table

## 2.3. Dimensions

All values given in the device dimensions are millimetres.

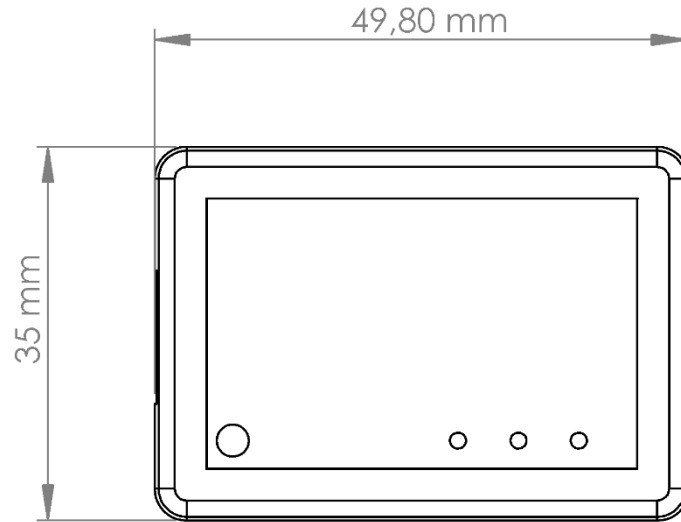

**Fig. 1:** Dimensions of LG/Beko/Arcelik AC - KNX Gateway from the top view

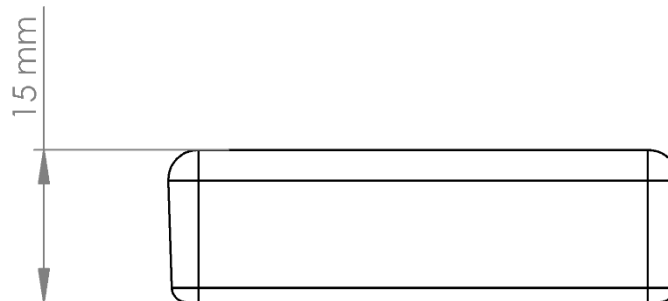

**Fig. 2:** Dimensions of LG/Beko/Arcelik AC - KNX Gateway from the side view

## 2.4. Connection Diagram & Features

Once the device is provided with a power supply from the KNX bus, both the physical address and the associated application program can be downloaded.

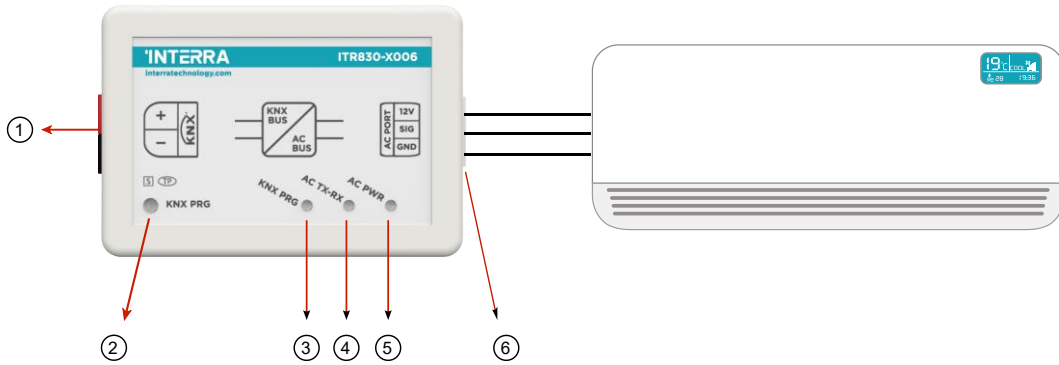

**Fig. 3:** Diagram of LG/Beko/Arcelik AC - KNX Gateway

Number	Feature
1	KNX Connector
2	KNX Programming Button
3	KNX Programming LED
4	AC Tx-Rx Communication LED
5	AC Power indicator LED
6	AC Indoor Unit connection

**Table 2:** LG/Beko/Arcelik AC – KNX Gateway Diagram

### Recommended



The interface should be installed inside the air conditioning indoor unit. Due to the connection length up to 50 meters, LG/Beko/Arcelik Gateway can also be installed at the proper location outside the air conditioner.

ITR830-X006 LG/Beko/Arcelik AC - KNX Gateway can be connected directly to the 12V-SIG-GND Home bus terminal of the AC indoor unit. Nothing that needs to do in ETS software. The following figure shows the LG/Beko/Arcelik Gateway connection without the remote controller.

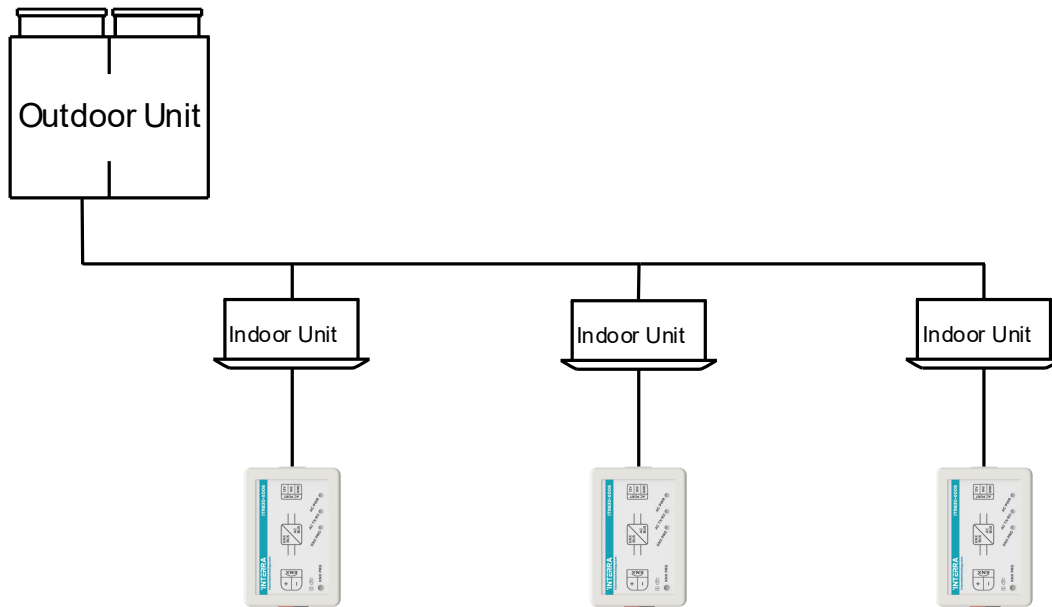

**Fig. 4:** LG/Beko/Arcelik Gateway Connection Diagram without LG/Beko/Arcelik Remote Controller

LG/Beko/Arcelik AC - KNX Gateway can be connected with LG/Beko/Arcelik Remote Controller to the 12V-SIG-GND Home bus terminal of the AC indoor unit. In this case, the remote control unit must be selected as Master in the LG/Beko/Arcelik Gateway ETS configuration. The following figure shows the LG/Beko/Arcelik Gateway connection with the remote controller.

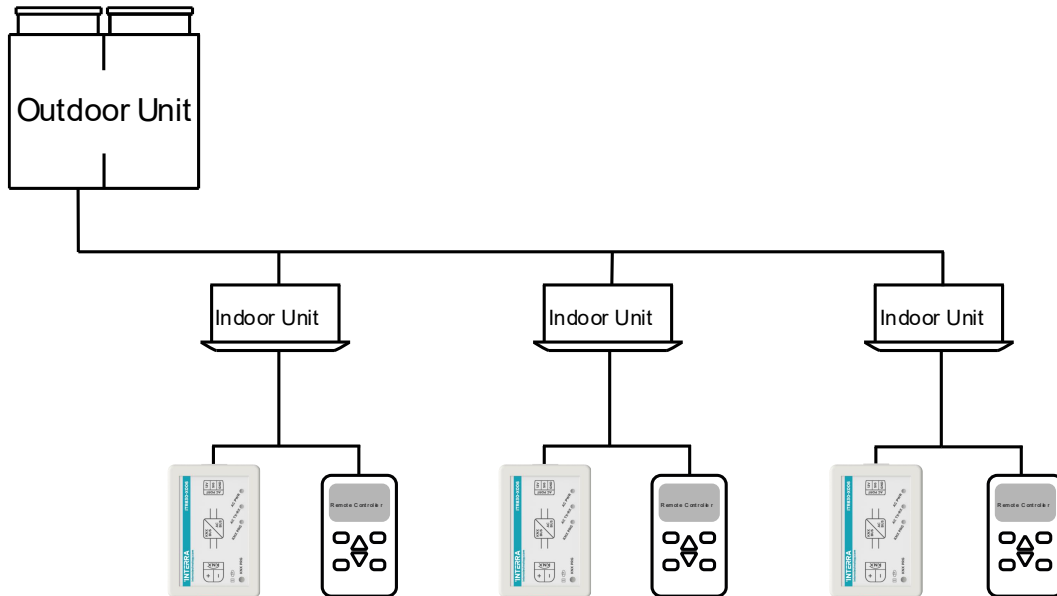

**Fig. 5:** LG/Beko/Arcelik Gateway Connection Diagram with LG/Beko/Arcelik Remote Controller

## Commissioning Instructions



- > First, disconnect the Air Conditioner from mains power.
- > Then, disconnect the power supply of the KNX bus.
- > Install the interface and connect it to the 12V-SIG-GND bus at any point of the bus. The 12V-SIG-GND bus is the bus that connects the AC indoor unit and the wired remote controller
- > Connect the KNX bus to the KNX connector of the interface according to polarity.
- > Reconnect the AC indoor unit to mains power and power supply to the KNX bus.

## 3. ETS Parameters & Descriptions

In this chapter, the ETS parameters of the ITR830-X006 LG/Beko/Arcelik AC - KNX Gateway device are described using the parameter pages and options. The parameter pages features are dynamic structures which mean further parameters and parameter pages are enabled depending on the configuration and function of the groups.

In this section, a detailed description of the functional features of the device is given. All the parameters of the device are explained under the relevant headings.

In the ETS parameter configuration pages, each of the parameters has got a default parameter value. These default values are written in bold.

- E.g. : > Setpoint shifting      • **via parameter**      via communication object

### Special Notes



This is a fully compatible KNX device that must be configured and setup using the standard KNX tool ETS.

In the following sections, there is a detailed explanation about each of the different functionalities of LG/Beko/Arcelik AC - KNX Gateway in ETS.

### 3.1. General Page

When the LG/Beko/Arcelik Gateway is attached to the project from the ETS program, a configuration setting must be made primarily before loading. When entering the “GENERAL” in the parameter page, the configuration screen will be appeared shown below. Global parameter settings for the whole device are made in this window. From the general configuration window, the different advanced functionalities of the LG/Beko/Arcelik Gateway can be enabled such as Module alive beacon, Setting the working condition of the remote controller, Behaviours after bus voltage failure, Device control locking, Errors Management, Initial Configuration.

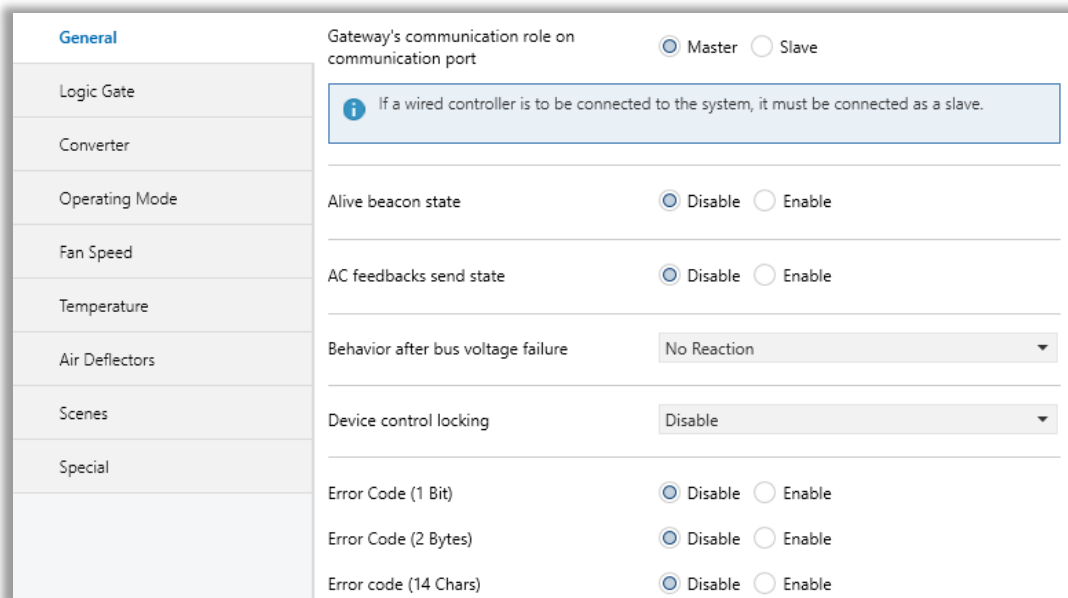

Fig. 6: General Configuration Parameter Page

### 3.1.1. Parameters List

PARAMETERS	DESCRIPTION	VALUES
Gateway's communication role on communication port	This parameter is used to determine whether the LG/Beko/Arcelik AC Gateway and the air conditioner wired remote controller are used together. If the wired remote control is to be used, the controller must be selected as the master. This parameters only available when there is only one air conditioner unit in system.	<b>Master</b> Slave
Alive beacon state	This feature is used to determine whether the LG/Beko/Arcelik AC Gateway is operating. With the enabling of the module alive beacon parameter whether the device is working correctly can be known.	<b>Disabled</b> Enabled
> Alive beacon interval <sup>1</sup>	This parameter is used to determine the time of the module alive beacon sending data in minutes.	00:01...00:05... 23:59
> Alive beacon output logic state <sup>1</sup>	The value "0" or "1 is sent with a period determined in "Alive beacon interval" parameter. The receipt of this telegram periodically means that the device is working properly.	Value '0' Value '1'
AC feedbacks send state	This parameter is used to get some status information on the air conditioning unit when the LG/Beko/Arcelik AC Gateway is started to operate. This information can be used for these purposes such as: monitoring the air conditioner from a control centre, triggering different scenarios to operate in the KNX infrastructure etc. The following describes which status information can be observed.  AC Working Status (On/Off) AC Operating Mode Fan Speed Setpoint Temperature	<b>Disabled</b> Enabled
> AC feedbacks time delay at startup <sup>2</sup>	This parameter is used to set the delay between the start-up and the sending of the feedback telegrams to the KNX bus line.	00:05...04:15 mm:ss
> AC feedbacks periodically <sup>2</sup>	This parameter is used to send feedback on the related objects periodically according to the time in second.	0...255

<p><b>Behaviour after bus voltage failure</b></p>	<p>This parameter is used to determine the action that will be taken by the gateway when the KNX bus voltage failure is recovered. If there is a power interruption, one of the following options can be applied.</p> <p><b>No Reaction:</b>The air conditioner returns the fabrica settings after the power failure.</p> <p><b>Last State:</b> The air conditioner unit retains its last condition after the power failure.</p> <p><b>AC ON:</b> The air conditioner will be switched on.</p> <p><b>AC OFF:</b> The air conditioner will be switched off.</p> <p><b>Scene:</b> The scene with the desired conditions from 5 different scenes can be sent to the air conditioner unit. In this case, the air conditioner unit operates under these conditions after KNX bus line power failure.</p>	<p><b>No reaction</b></p> <p>Last state</p> <p>AC ON</p> <p>AC OFF</p> <p>Scene</p>
<p>&gt; <b>Scene selection<sup>3</sup></b></p>	<p>This parameter is used to determine the appropriate scene from the 5 scenes that can be created. The selected scene conditions are applied to the air conditioner and it works under these conditions after the KNX bus power failure.</p>	<p><b>Scene 1, Scene 2, Scene 3, Scene 4, Scene 5</b></p>
<p><b>Device Control Locking</b></p>	<p>This parameter is used to lock the LG/Beko/Arcelik Gateway via device control locking communication object. The device is blocked and it can no longer be controlled via any telegram. The device remains the previous status before locking until the locking is deactivated. It must be taken into consideration that the device after the locking will take the last value received through the bus even though this value has been received during the locking time.</p> <p><b>Lock on '0':</b> The Gateway will be locked when the value 0 is sent.</p> <p><b>Lock on '1':</b> The Gateway will be locked when value 1 is sent.</p>	<p><b>Disabled</b></p> <p>Lock on '0'</p> <p>Lock on '1'</p>
<p><b>Error code (1 Bit)</b></p>	<p>This parameter is used to detect the faults that come from the air conditioner via a 1 bit value.</p>	<p><b>Disabled</b></p> <p>Enabled</p>

<p><b>Error code (2 Bytes)</b></p>	<p>This parameter is used to detect and identify the faults that come from the air conditioner via a 2-byte value. Each error code has a different meaning so, all of the error code descriptions are listed please check the Appendix section in this document.</p>	<p><b>Disabled</b> <b>Enabled</b></p>
<p><b>Error code (14 Chars)</b></p>	<p>This parameter is used to detect and identify the faults that come from the air conditioner via a 14 chars value. Each error code has a different meaning so, all of the error code descriptions are listed please check the Appendix section in this document.</p>	<p><b>Disabled</b> <b>Enabled</b></p>

<sup>1</sup> This parameter is visible when the function “Alive beacon state” is set to “Enable”.

<sup>2</sup> This parameter is visible when the function “AC feedbacks send state” is set to “Enable”.

<sup>3</sup> This parameter is visible when the function “Behaviour after bus voltage failure” is set to “Scene”.

### 3.2. Logic Gate

This parameter page is used to make the logical relationships between inputs & output.

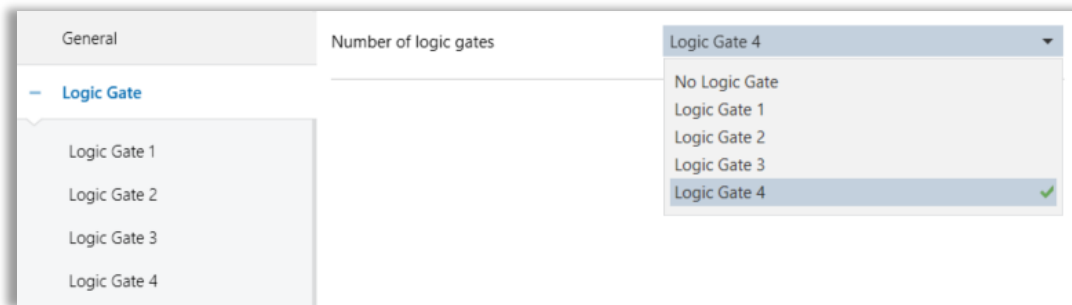

Fig. 7: Logic Gate Configuration Parameter Page

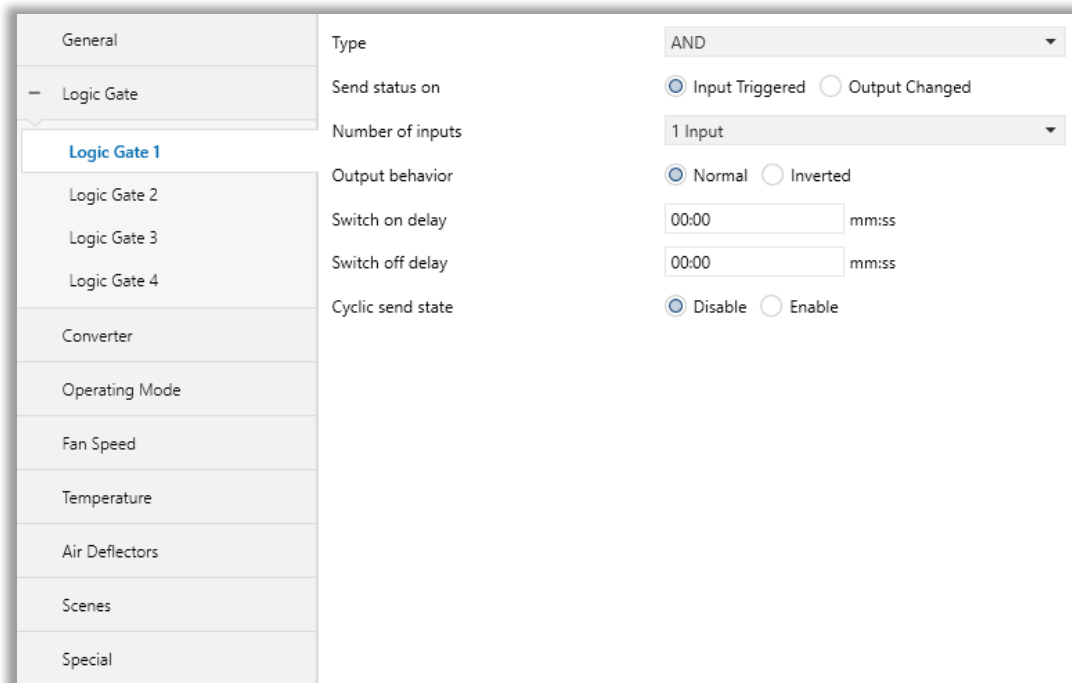

Fig. 8: Logic Gate Configuration Parameter Page

Up to 4 logic gates can be used with the gateway. In addition, each logic gate allows the use of up to 4 inputs. The standard logic operations AND, OR and XOR are available.

The status of the output of logic gates can be shown normally or inverted. This configuration can be applied via the parameter “Output behaviour” and when it is parameterized as inverted, the status of the output is shown inverted.

Through the parameter “Send status on”, the type of feedback can be defined. The gateway allows sending the result of logic gates when the conversely logic output is changed or when one of the logic inputs is modified. Additionally, it is possible to define a cyclic sending of the feedback which permits getting information about the output status periodically.

The logic output can operate with previously configured delays. The logic output takes the values ON and OFF with delays. Depending on the switch delay parameters configuration, it is possible to set an ON delay (TON), an OFF delay (TOFF) or both at the same time.

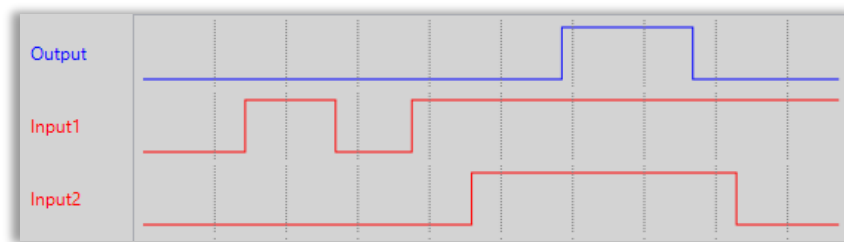

Fig. 9: Logic Gate with Delays

## Special Notes



The number of logical gates can be selected up to 4. Since the characteristics of each gate are the same, only Logic 1 is described.

### 3.2.1. Parameters List

PARAMETERS	DESCRIPTION	VALUES
<b>Number of logic gates</b>	This parameter is used to specify the number of logic gates that are used to write logical functions. Up to 4 different logic gates can be used simultaneously.	<b>No logic gate</b> Logic Gate 1 Logic Gate 2 Logic Gate 3 Logic Gate 4
<b>LOGIC GATE X</b>		
<b>Type</b>	This parameter is used to specify the type of logical gate to be used. There are 3 different logic gate types, AND, OR and XOR. Each logical gate generates a false or true value at its output as a logical association result.	<b>AND</b> <b>OR</b> <b>XOR</b>
<b>Send status on</b>	This parameter is used to specify how the status of the output will be sent. <b>Input Triggered:</b> Output status will be sent when any logic input is received. <b>Output Chaged</b> Output status will be sent when the logic output is changed.	<b>Input Triggered</b> Output Chaged
<b>Number of inputs</b>	This parameter is used to specify the number of inputs for the logical gate.	<b>1 input</b> 2 inputs 3 inputs 4 inputs
<b>Output behaviour</b>	This parameter defines the behaviour of the logic output. <b>Normal:</b> The status of the output is sent without any modification. <b>Inverted:</b> If the value is true, the false value will be sent as a status value for the output or vice versa.	<b>Normal</b> Inverted
<b>Switch on delay</b>	This parameter is used to set a delay time for output behaviour. The output communication object takes the value TRUE when time reaches the configured time in this parameter.	<b>00:00...04:15 mm:ss</b>
<b>Switch off delay</b>	This parameter is used to set a delay time for output behaviour. The output takes the value	<b>00:00...04:15 mm:ss</b>

	FALSE when time reaches the configured time in this parameter.	
<b>Cyclic send state</b>	This parameter is used to send feedback on the related objects periodically according to the determined time in "Send feedback periodically" parameter.	<b>Disabled</b> Enable
<b>&gt;Send feedback periodically<sup>1</sup></b>	This parameter determines the LogicX output communication object sending period in minutes.	<b>00:01...04:15</b> hh:mm

<sup>1</sup> This parameter is visible when the function "Cyclic send state" is set to "Enable".

## Special Notes



The number of logical gates can be selected up to 4. Since the characteristics of each gate are the same, only one is described.

### 3.3. Converter

The main parameter settings of the Converter Parameter page are made on this page. Various control options for the Converters are enabled from this page.

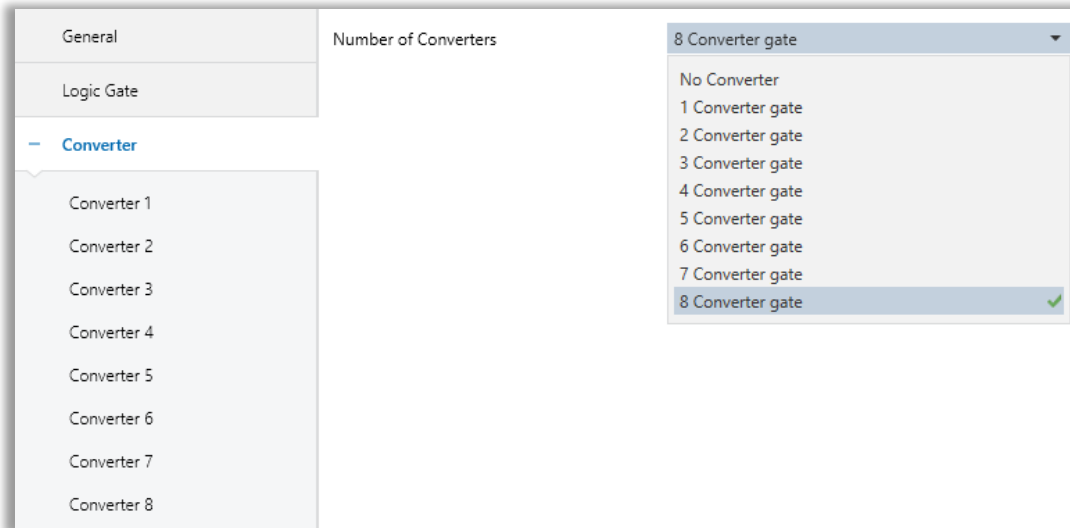

Fig. 10: Converter Configuration Parameter Page

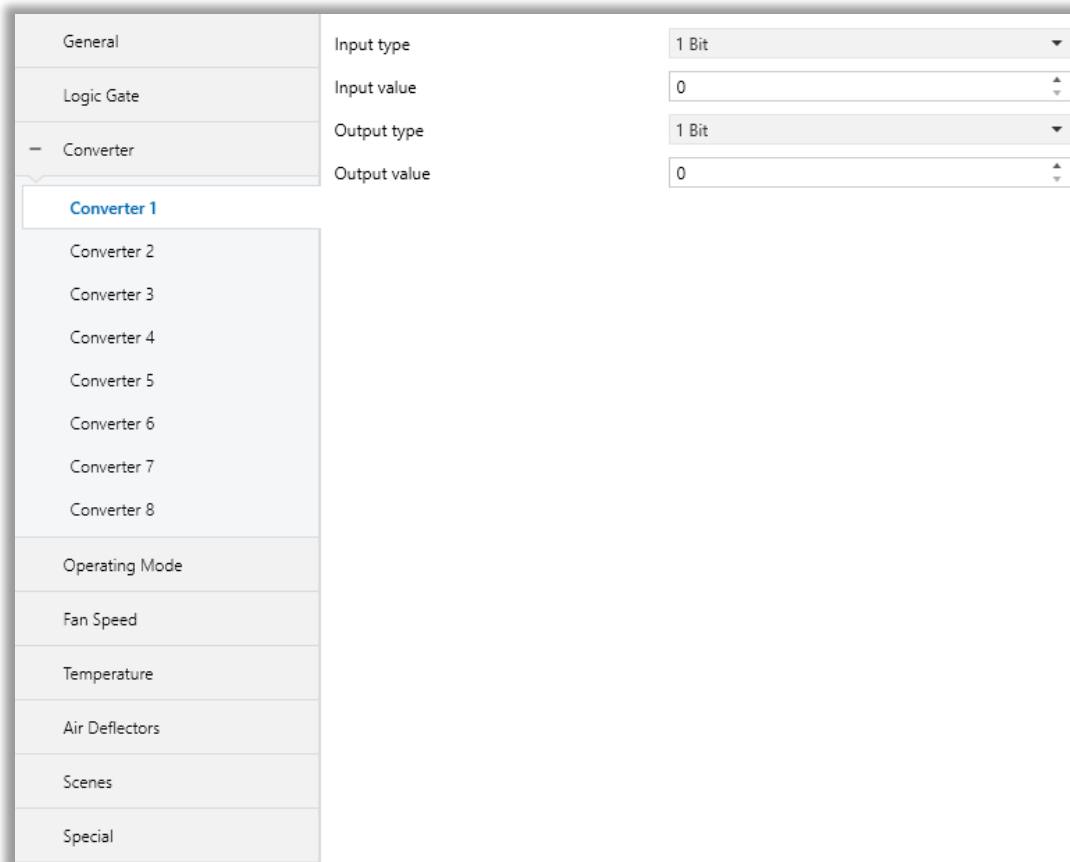

Fig. 11: Converter X Configuration Parameter Page

Converters are used to convert the output to configured type value depending on the input value. There are 8 different types of data input that can be converted to 4 different data values.

Moreover, if the input is selected as 1 byte or 2 bytes, you can also make the four arithmetical operations (plus, minus, multiply, divide). Some examples are shown below :

<p><b><i>Ex 1:</i></b> Input type: 1 byte, 154 Calculation: Plus Calculation value: 7 Output type: 1 byte Output = <math>154 : 7</math> Output = 22</p>	<p><b><i>Ex 2:</i></b> Input type: 1 byte, 215 Calculation: Minus Calculation value: 51 Output type: 1 byte Output = <math>215 - 51</math> Output = 164</p>
<p><b><i>Ex 3:</i></b> Input type: 2 bytes, 862 Calculation: Multiply Calculation value: 49 Output type: 2 bytes Output = <math>862 \times 49</math> Output = 42238</p>	<p><b><i>Ex 4:</i></b> Input type: 2 bytes, 46342 Calculation: Divide Calculation value: 986 Output type: 2 bytes Output = <math>46342 : 986</math> Output = 47</p>

## Special Notes





The number of Converters can be selected up to 8. Since the characteristics of each gate are the same, only one is described.

**3.3.1. Parameters List**

PARAMETERS	DESCRIPTIONS	VALUES
<b>Number of Converters</b>	This parameter is used to determine the number of converter gates. Each converter gate can be set independently.	<b>No converter</b> 1 Converter gate 2 Converter gate 3 Converter gate 4 Converter gate 5 Converter gate 6 Converter gate 7 Converter gate 8 Converter gate
<b>CONVERTER X</b>		
<b>Input type</b>	This parameter is used to specify the type of input value for the converter input. There are 8 different input values for each converter.  When the input type is configured as 1-byte or 2- byte logic, the output data type is set as 1 bit. If the input value is non-zero, the output value will be 1. Otherwise, it will be zero.	<b>1 Bit</b> 2 Bits 1 Byte 2 Bytes 1 Byte Logic 2 Bytes Logic 1 Byte Threshold 2 Bytes Threshold
<b>&gt; Input value<sup>1</sup></b>	This parameter is used to set the value of the converter input. Several value types can be selected and these possible values are described below.  The input type is 1 Bit: If the input type is selected as 1 bit, values are between 0-1.  The input type is 2 Bits: If the input type is selected as 2 bits, values are between 0-3.  The input type is 1 Byte: If the input type is selected as 1 byte, values are between 0-255.  The input type is 2 Bytes: If the input type is selected as 2 bytes, values are between 0-65535.	<b>0...1</b> <b>0...3</b> <b>0...255</b> <b>0...65535</b>

	<p>The input type is 1 Byte logic : If the input type is selected as 1-byte logic, values are between 0-255.</p> <p>The input type is 2 Bytes logic : If the input type is selected as 2-byte logic, values are between 0-65535.</p> <p>The input type is 1 Byte Threshold : If the input type is selected as a 1-byte threshold, values are between 0-255.</p> <p>The input type is 2 Byte Threshold : If the input type is selected as the 2-byte threshold, values are between 0-65535.</p>	
> Logical Operators <sup>2</sup>	<p>This parameter is used to perform a mathematical operation with the input value.</p> <p><b>Disabled:</b> The calculation value is disabled. The input value is converted to output value without a mathematical operation.</p> <p><b>Plus:</b> The calculation value is summed with the input value and the result is applied to the output value.</p> <p><b>Minus:</b> The calculation value is subtracted from the input value and the result is applied to the output value.</p> <p><b>Multiply:</b> Input value and calculation value are multiplied and the result is applied to the output value.</p> <p><b>Divide:</b> The input value is divided by the calculation value and the result is applied to the output value.</p>	<p><b>Disabled</b></p> <p>Plus</p> <p>Minus</p> <p>Multiply</p> <p>Divide</p>
Calculation Value <sup>3</sup>	<p>This parameter is used to specify the value to be processed along with the input value. This value type is the same as the output value type.</p>	<p>0...255</p> <p>0...65535</p>
Lower Limit <sup>4</sup>	<p>This parameter is used to set the lower limit value of the threshold for the input when the input is configured as 1 byte or 2-byte threshold.</p>	<p>0...255</p> <p>0...65535</p>

	<p> Lower limit value can not be higher than Upper limit value.</p>	
<b>Higher Limit<sup>4</sup></b>	<p>This parameter is used to set the higher limit value of the threshold for the input when the input is configured as 1 byte or 2-byte threshold.</p> <p> Upper limit value can not be lower than Lower limit value.</p>	<p>0...255</p> <p>0...65535</p>
<b>Output type<sup>1</sup></b>	<p>This parameter is used to specify the type of output value for the converter output. There are 4 different output values for each converter.</p>	<p>1 Bit</p> <p>2 Bit</p> <p>1 Byte</p> <p>2 Byte</p>
<b>Output value<sup>1</sup></b>	<p>This parameter is used to set the value of the converter output. Several value types can be selected and these possible values are described below.</p> <p>The output type is 1 Bit: If the input type is selected as 1 bit, values are between 0-1.</p> <p>The output type is 2 Bit: If the input type is selected as 2 bits, values are between 0-3.</p> <p>The output type is 1 Byte: If the input type is selected as 1 byte, values are between 0-255.</p> <p>The output type is 2 Byte: If the input type is selected as 2 bytes, values are between 0-65535.</p>	<p>0...1</p> <p>0...3</p> <p>0...255</p> <p>0...65535</p>

<sup>1</sup> This parameter is visible when the function "Input type" is set to "1 Bit" or "2 Bits" or "1 Byte" or "2 Bytes".

<sup>2</sup> This parameter is visible when the function "Input type" is set to "1 Byte" or "2 Bytes".

<sup>3</sup> This parameter is visible when the function "Logical Operators" is set to "Plus" or "Minus" or "Multiply" or "Divide". If

<sup>4</sup> This parameter is visible when the function "Input type" is set to "1 Byte Threshold" or "2 Byte Threshold".

### 3.4. Operating Mode

In this section, all of the parameters are corresponding to different mode properties and communication objects. Some parameters of related objects and their tasks are described below.

- **Operating Mode Heat/Cool object (1 bit)** : The operating mode of the air conditioner can be selected as the heating mode or cooling mode with this 1-bit object.
- **Operating mode +/- object (1 bit)** : Using this object 5 different operating modes can be selected. The selection can be made with 1-bit values. Switching between the modes is done according to the following condition:

Fig. 12: Operating Modes Sequences

- **Operating\_Mode**: The operating mode can be modified with these values that are shown in the table below:

OPERATING MODE	VALUE
AUTO	0
HEAT	1
COOL	3
FAN	9
DRY	14

Table 3: Operating Mode List

- **Operating Mode Cool/Heat**: The operating mode of the air conditioner can be selected as the heating mode or cooling mode with this 1-bit object.
- **Mode Individual objects (1-bit)**: The operating mode can be modified by sending value 1 to the desired mode object.

- **Mode +/- object (1 bit)** : Using this object 4 different operating modes can be selected. The selection can be made with 1-bit values. Switching between the modes is done according to the following condition :

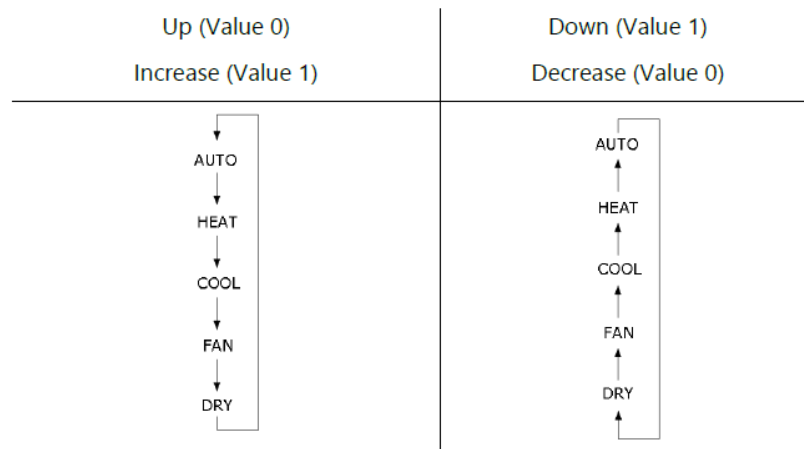

- **Mode Percent Value Objects (Mode Heating\_Percentage - Mode Cooling\_Percentage)**: Via these 1-byte objects the indoor unit can be controlled via percentage values to provide compatibility with the thermostat that uses this data type. By using this object, there are two different options:
- Priority to “Operating mode Heat/Cool” : Disabled

When the priority of "Operating mode Heat/Cool" is disabled, it does not matter what is the current mode of the indoor unit, the percentage values can switch the mode and activate the indoor unit in the following way:

- If the object “Mode Heating\_Percentage” takes a value greater than 0, the indoor unit will be switched ON in HEAT mode. The value 0 will switch off the air conditioner.
- If the object “Mode Cooling\_Percentage” takes a value greater than 0, the indoor unit will be switched ON in COOL mode. The value 0 will switch off the air conditioner.

## Special Notes



- When the priority is disabled and the air condition unit is working as FAN or DRY modes, a new value to the objects “Mode Heating\_Percentage - Mode Cooling\_Percentage” or “Operating Mode Cool/Heat” will change the mode to HEAT or COOL.
- In Auto mode, the air conditioner sets the operating mode (heat or cool) and operates in that mode.

- Priority to “Operating mode Heat/Cool” : Enabled

When the priority is enabled, the operating mode defined cannot be modified by the percentage value objects and the behaviour will be as follow:

Actual operating mode as HEAT;

- If the object “Mode Heating\_Percentage” takes a value greater than 0, the indoor unit will be switched ON. The value 0 will switch off the air conditioner.

- Any data received via the object “Mode Cooling\_Percentage” will not be taken into consideration.

Actual operating mode as COOL;

- If the object “Mode Cooling\_Percentage” takes a value greater than 0, the indoor unit will be switched ON. The value 0 will switch off the air conditioner.
- Any data received via the object “Mode Heating\_Percentage” will not be taken into consideration.

## Special Notes



When the priority is enabled and the air condition unit is working as FAN or DRY modes, a new value to the objects “Mode Heating\_Percentage - Mode Cooling\_Percentage” will not be taken into consideration. Only a new value to the object “Operating Mode Cool/Heat” will change the mode to HEAT or COOL.

## Special Notes



Any modification on all above objects will be advised in the following feedback objects:

- Mode Cool/Heat Feedback
- Mode Auto Feedback
- Mode Heat Feedback
- Mode Cool Feedback
- Mode Fan Feedback
- Mode Dry Feedback
- Operating Mode Feedback
- Operating Mode Text Feedback

**3.4.1. Parameters List**

PARAMETERS	DESCRIPTION	VALUES
<b>Operating mode Heat/Cool object</b>	<p>This parameter is used to enable or disable the operating mode heat/cool and its feedback objects.</p> <p><b>Normal:</b> If value 1 is sent via a related object, the air conditioner switches to heat mode.</p> <p><b>Inverted:</b> If value 1 is sent via a related object, the air conditioner switches to cool mode.</p>	<p><b>Disabled</b></p> <p>Normal</p> <p>Inverted</p>
<b>Operating mode +/- object</b>	<p>This parameter is used to enable or disable the operating mode +/- object.</p> <p><b>Normal(1:Increase/0:Decrease):</b> If the value 1 is sent, the modes switch according to the following sequence Auto-&gt;Heat-&gt;Cool-&gt;Fan-&gt;Dry</p> <p><b>Inverted(0:Up/1:Down):</b> If the value 0 is sent, the modes switch according to the following sequence Auto-&gt;Heat-&gt;Cool-&gt;Fan-&gt;Dry</p>	<p><b>Disabled</b></p> <p>Normal</p> <p>Inverted</p>
<b>Operating mode individual objects</b>	<p>This parameter is used to enable the operating modes individual objects. These objects are :</p> <ul style="list-style-type: none"> <li>-&gt;Mode Auto</li> <li>-&gt;Mode Heat</li> <li>-&gt;Mode Cool</li> <li>-&gt;Mode Fan</li> <li>-&gt;Mode Dry</li> </ul>	<p><b>Disabled</b></p> <p>Enabled</p>
<b>Operating mode HVAC object</b>	<p>This parameter is used to enable or disable operating mode objects. Via this object, if the specified values are sent to the corresponding mode the operating mode is switched to that mode.</p>	<p><b>Disabled</b></p> <p>Enabled</p>
<b>Operating mode percentage value objects</b>	<p>This parameter is used to enable the percent value objects of heating mode and cooling mode.</p>	<p><b>Disabled</b></p> <p>Enabled</p>
<b>&gt; Priority to "Operating mode Heat/Cool"<sup>1</sup></b>	<p>This parameter is used to enable or disable the giving priority to operating mode Heat/Cool.</p>	<p><b>Disabled</b></p> <p>Enabled</p>

<b>Feedback operating mode individual objects (1 Bit)</b>	This parameter is used to enable or disable the feedback objects of individual operating mode objects. If this parameter is enabled, all of the individual feedback objects of operating modes are visible.	<b>Disabled</b> Enabled
<b>Feedback operating mode objects (1 Byte)</b>	This parameter is used to enable or disable the 1 Byte feedback object of the operating mode. According to special values, the operating mode can be easily detected.	<b>Disabled</b> Enabled
<b>Feedback operating mode text object (14 Chars)</b>	This parameter is used to enable or disable the feedback operating text mode objects.	<b>Disabled</b> Enabled
<b>-&gt; Text feedback for mode AUTO<sup>2</sup></b>	This parameter is used to type a special name for the operating mode AUTO feedback text object.	-
<b>-&gt; Text feedback for mode HEAT<sup>2</sup></b>	This parameter is used to type a special name for the operating mode HEAT feedback text object.	-
<b>-&gt; Text feedback for mode COOL<sup>2</sup></b>	This parameter is used to type a special name for the operating mode COOL feedback text object.	-
<b>-&gt; Text feedback for mode FAN<sup>2</sup></b>	This parameter is used to type a special name for the operating mode FAN feedback text object.	-
<b>-&gt; Text feedback for mode DRY<sup>2</sup></b>	This parameter is used to type a special name for the operating mode DRY feedback text object.	-

<sup>1</sup> This parameter is only visible when the parameter "Operating mode percentage value objects" is set to "Enabled".

<sup>2</sup> This parameter is only visible when the parameter "Feedback operating mode text object (14 Chars)" is set to "Enabled".

### 3.5. Fan Speed

In this parameter page, the parameter “Fan mode available” defines if the fan mode is available in the indoor unit. If this parameter is set to “No”, all the fan parameters and objects are hidden. All the parameters in this section are related to the Fan Speed properties and communication objects.

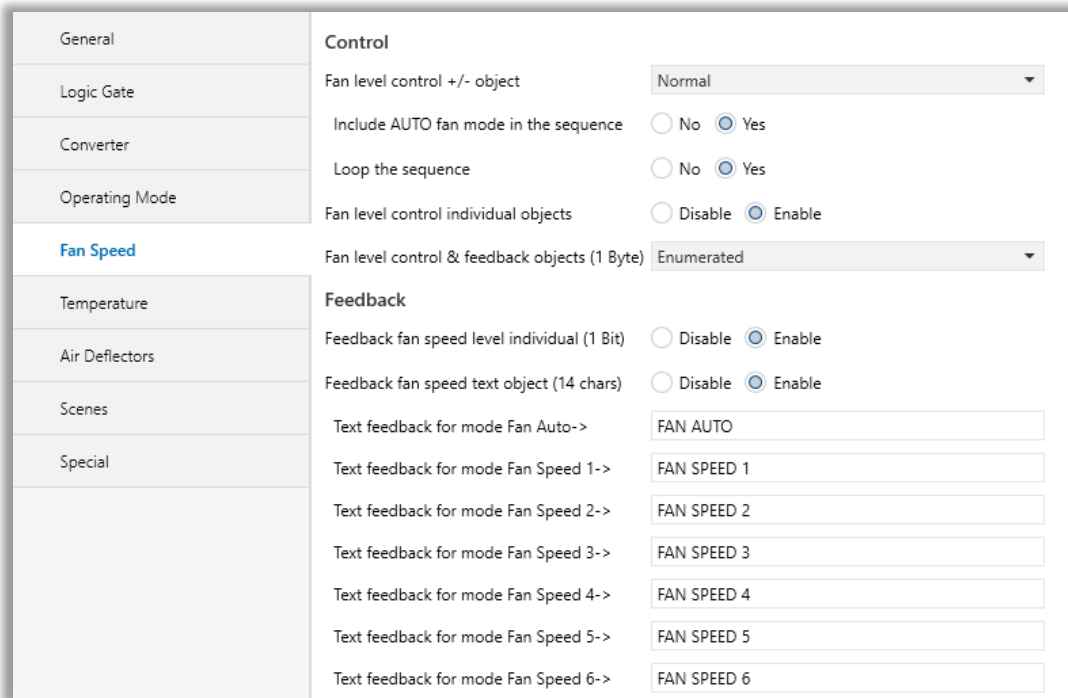

Fig. 13: Fan Configuration Parameter Page

**Important Notes**



•Maximum level of fan speed depends the model of air conditioner unit. Please refer the user manual of air conditioner manual.

**Fan Speed Enumerated/Scaling:** The fan speed can be driven by "numbered or scaled object," selectable by the parameter "Fan level control & feedback objects (1 byte)".

Fan speed Enumerated object can control fan speed of air conditioner via 1 byte object.

FAN SPEED	VALUE
FAN AUTO	0
FAN 1	1
FAN 2	2
FAN 3	3
FAN 4	4
FAN 5	5
FAN 6	6

Table 4: Fan Speed - Enumerated Value Table

**Fan Speed Scaling** object can control the fan speed of the air conditioner according to the value range of predefined parameters.

Example:

If "Fan Speed Scaling" communication object value has given 18%, fan level set to Fan speed 1

Fan level control & feedback objects (1 Byte)	Scaling
Fan speed 1 lower limit (%)	0
Fan speed 2 lower limit (%)	20

**Fig. 14:** Fan Speed Scaling Configuration

- **Fan Speed Individual objects (1-bit):** The fan speed of the air conditioner can be selected as the speed auto to 7 with this 1-bit object. When the "Fan Speed Auto Control" object is deactivated, fan speed returns to the previous position before activated that object.
- **Fan Speed +/- object:** Using this object 8 different fan speeds can be selected. The selection can be made with 1-bit values. Switching between the fan speed depends to selected parameters.

\*If the "Loop the sequence" parameter is enabled, the loop changes according to the state of the "Include AUTO fan mode in the sequence" parameter. If the " Include AUTO fan mode in the sequence " parameter is enabled, the increment after Fan speed 5 sets the fan speed level to AUTO. Subsequent increments continue arithmetically.

**Special Notes**



If a value greater than 6 is received, this data will be accepted and the fan will set at the maximum speed.

**Special Notes**



Any modification on all above objects will be advised in the following feedback objects:  
 Fan Speed Enumerated Feedback  
 Fan Speed Auto Feedback  
 Fan Speed X Feedback,  
 Fan Speed Text Feedback  
 \*X: 1/2/3/4/6

### 3.5.1. Parameters List

PARAMETERS	DESCRIPTION	VALUES
Fan level control +/- object	<p>This parameter is used to enable or disable the fan level control +/- object.</p> <p><b>Normal (1:Increase/0:Decrease):</b> If the value 1 is sent, the fan levels switch according to the following sequence</p> <p>Auto-&gt;Fan Level 1-&gt; ... -&gt; Fan Level Max</p> <p><b>Inverted (0:Up/1:Down):</b> If the value 1 is sent, the fan levels switch according to the following sequence</p> <p>Fan Level Max-&gt; ... -&gt;Fan Level 1-&gt;Auto</p>	<p><b>Disabled</b></p> <p>Normal</p> <p>Inverted</p>
> Include AUTO fan mode in the sequence <sup>1</sup>	This parameter is used to add AUTO fan mode to fan levels.	<p><b>No</b></p> <p>Yes</p>
> Loop the sequence <sup>1</sup>	This parameter is used to enable or disable the fan level sequence repeating considering the selected parameter polarity.	<p><b>No</b></p> <p>Yes</p>
Fan level control individual objects	<p>This parameter is used to enable or disable the fan level control individual objects. For each fan speed level, there is an individual fan speed object. These objects are:</p> <p>Fan Speed 1 Control</p> <p>Fan Speed 2 Control</p> <p>Fan Speed 3 Control</p> <p>Fan Speed 4 Control</p> <p>Fan Speed 5 Control</p> <p>Fan Speed 6 Control</p> <p>Fan Speed Auto Control</p>	<p><b>Disabled</b></p> <p>Enabled</p>
Fan level control & feedback objects (1 Byte)	<p>This parameter is used to determine the fan level control type with 1-byte communication objects</p> <p><b>Scaling:</b> Via scaling object, according to the threshold defined in parameters fan speed will be determined.</p> <p><b>Enumerated:</b> Via enumerated object, if value 0 is sent fan level will be fan speed auto. Likewise, value 2 causes fan speed 2 and value 3 causes fan speed 3 etc.</p>	<p><b>Disabled</b></p> <p>Scaling</p> <p>Enumerated</p>
> Fan speed 1 lower limit (%) <sup>2</sup>	This parameter is used to set the lower limit 1 fan level threshold value to compare with the received value from the KNX bus line. After comparison, the corresponding fan speed will be chosen.	<b>0...100</b>

> Fan speed 2 lower limit (%) <sup>2</sup>	This parameter is used to set the lower limit 2 fan level threshold value to compare with the received value from the KNX bus line. After comparison, the corresponding fan speed will be chosen.	0...100
> Fan speed 3 lower limit (%) <sup>2</sup>	This parameter is used to set the lower limit 3 fan level threshold value to compare with the received value from the KNX bus line. After comparison, the corresponding fan speed will be chosen.	0...100
> Fan speed 4 lower limit (%) <sup>2</sup>	This parameter is used to set the lower limit 4 fan level threshold value to compare with the received value from the KNX bus line. After comparison, the corresponding fan speed will be chosen.	0...100
> Fan speed 5 lower limit (%) <sup>2</sup>	This parameter is used to set the lower limit 5 fan level threshold value to compare with the received value from the KNX bus line. After comparison, the corresponding fan speed will be chosen.	0...100
> Fan speed 6 lower limit (%) <sup>2</sup>	This parameter is used to set the lower limit 5 fan level threshold value to compare with the received value from the KNX bus line. After comparison, the corresponding fan speed will be chosen.	0...100
<b>Feedback fan speed level individual (1 Bit)</b>	This parameter is used to enable or disable the individual fan level object feedbacks.	<b>Disabled</b> Enabled
<b>Feedback fan speed text object (14 chars)</b>	This parameter is used to enable or disable the feedback fan level text object.	<b>Disabled</b> Enabled
-> Text feedback for mode Fan Auto <sup>3</sup>	This parameter is used to type a special name for Auto mode text feedback.	-
-> Text feedback for mode Fan Speed 1 <sup>3</sup>	This parameter is used to type a special name for fan speed 1 text feedback.	-
-> Text feedback for mode Fan Speed 2 <sup>3</sup>	This parameter is used to type a special name for fan speed 2 text feedback.	-
-> Text feedback for mode Fan Speed 3 <sup>3</sup>	This parameter is used to type a special name for fan speed 3 text feedback.	-
-> Text feedback for mode Fan Speed 4 <sup>3</sup>	This parameter is used to type a special name for fan speed 4 text feedback.	-
-> Text feedback for mode Fan Speed 5 <sup>3</sup>	This parameter is used to type a special name for fan speed 5 text feedback.	-
-> Text feedback for mode Fan Speed 6 <sup>3</sup>	This parameter is used to type a special name for fan speed 6 text feedback.	-

<sup>1</sup> This parameter is only visible when the parameter "Fan level control +/- object" is set to "Normal" or "Inverted".

<sup>2</sup> This parameter is only visible when the parameter "Fan level control & feedback objects (1 Byte)" is set to "Scaling".

<sup>3</sup> This parameter is only visible when the parameter "Feedback fan speed text object (14 Chars)" is set to "Enabled".

### 3.6. Air Deflectors

On this parameter page, all the parameters are related to the Vanes properties and communication objects. The parameter “Air deflector control available” defines if the vanes control is available in the indoor unit. If this parameter is set to “No”, all the fan parameters and objects are hidden.

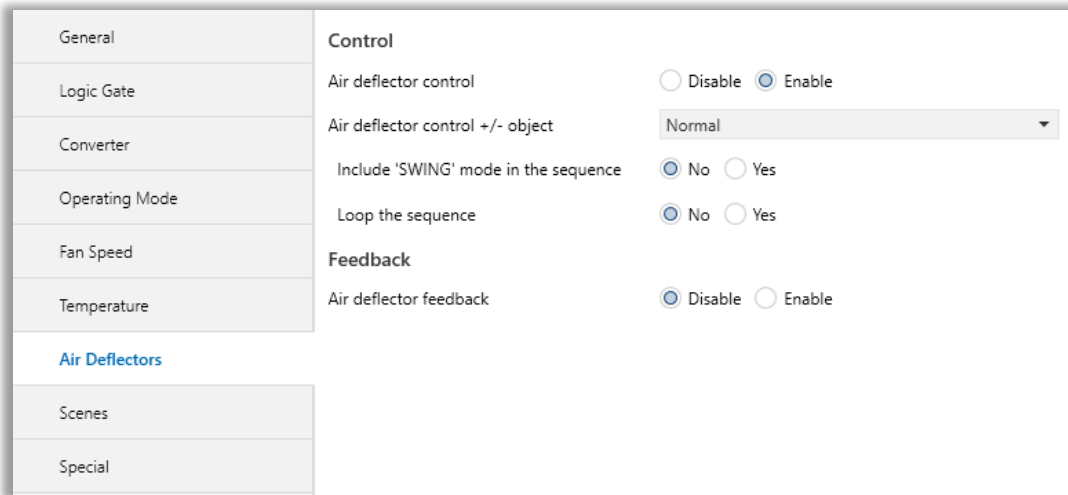

Fig. 15: Air Deflectors Configuration Parameter Page

#### Important Notes



- This function can be named as vertical louver, flaps or airflow direction in air conditioner manuals.
- Air deflector cannot be set when AC is OFF.
- This gateway and the some wired remote controller is unable to control horizontal swing in indoor unit.
- The range of vane angles setting can be changed to 5 levels or 6 levels according to the product.



**Air Deflector Control:**

The air deflector position can be set via some different methods:

- Air deflector position can be controlled by sending 1-bit values via “Air Deflector +/-“ object. While using this method the following sequence is applied:

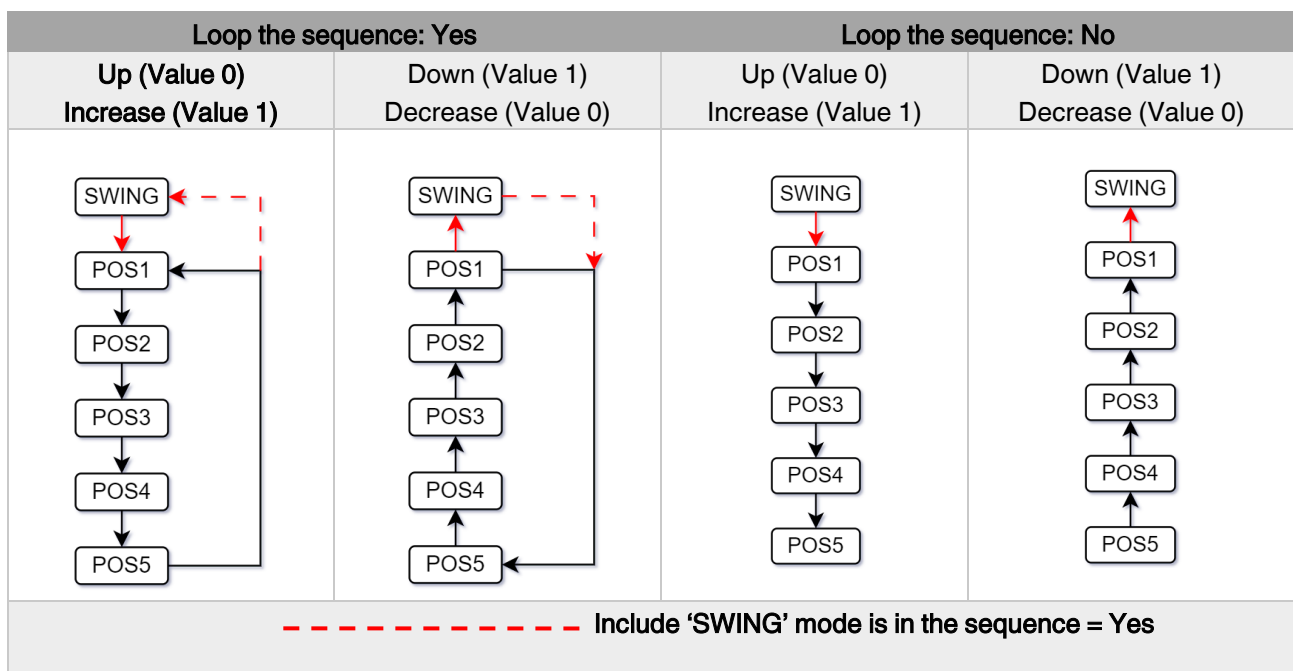

- Air deflector positions can be controlled by sending the numbers of each position: 1, 2, 3, 4 or 5 via “Air Deflector Broadcast Value” communication objects.

**Special Notes**



If a value greater than 5 , this data will be discarded and the vanes will remain in the current position.

**Special Notes**



Any modification on all above objects will be advised in the following feedback object:  
**Air Deflector Feedback**

### 3.6.1. Parameters List

PARAMETERS	DESCRIPTION	VALUES
<b>Air deflector control</b>	<p>This parameter is used to enable or disable the air deflector control function. If this parameter is selected as Enable, all of the air deflector parameters will be visible and air deflector can be control via 1 Byte communication object.</p> <p>Via 1 Byte object, if value 1 is sent air deflector position will be position 1. Likewise, value 2 causes air deflector position 2 and so on.</p>	<p><b>Disable</b></p> <p>Enable</p>
<b>Air deflector control +/- object</b>	<p>This parameter is used to enable the air deflector control object to change the desired air deflector position.</p> <p><b>Normal (0-Decrease;1-Increase):</b> If the value 1 is sent, the air deflector position switches according to the following sequence</p> <p>Swing-&gt;Pos 1-&gt;Pos 2-&gt;Pos 3-&gt;Pos 4-&gt;Pos 5.</p> <p><b>Inverted (0-Up;1-Down):</b> If the value 0 is sent, the air deflector position switches according to the following sequence</p> <p>Swing-&gt;Pos 1-&gt;Pos 2-&gt;Pos 3-&gt;Pos 4-&gt;Pos 5.</p>	<p><b>Disabled</b></p> <p>Normal</p> <p>Inverted</p>
<b>&gt; Include 'SWING' mode in the sequence<sup>1</sup></b>	<p>This parameter is used to include the SWING function in the air deflector position sequence. If air deflector position is selected as 1, the SWING feature will come from before the pos 1 in the sequence.</p>	<p><b>No</b></p> <p>Yes</p>
<b>&gt; Loop the sequence<sup>1</sup></b>	<p>This parameter is used to control the sequence in a loop. According to air deflector position +/- object configuration polarity, the sequence will be repeated.</p>	<p><b>No</b></p> <p>Yes</p>
<b>Air deflector feedback</b>	<p>This parameter enables feedback object.</p>	<p><b>Disabled</b></p> <p>Enable</p>

<sup>1</sup> This parameter is only visible when the parameter "Air deflector control +/- object" is set to "Normal" or "Inverted".

### 3.7. Temperature

In this section, all of the parameters are corresponding to the setpoint temperature, AC unit ambient temperature. Some parameters of related objects and their tasks are described in this part.

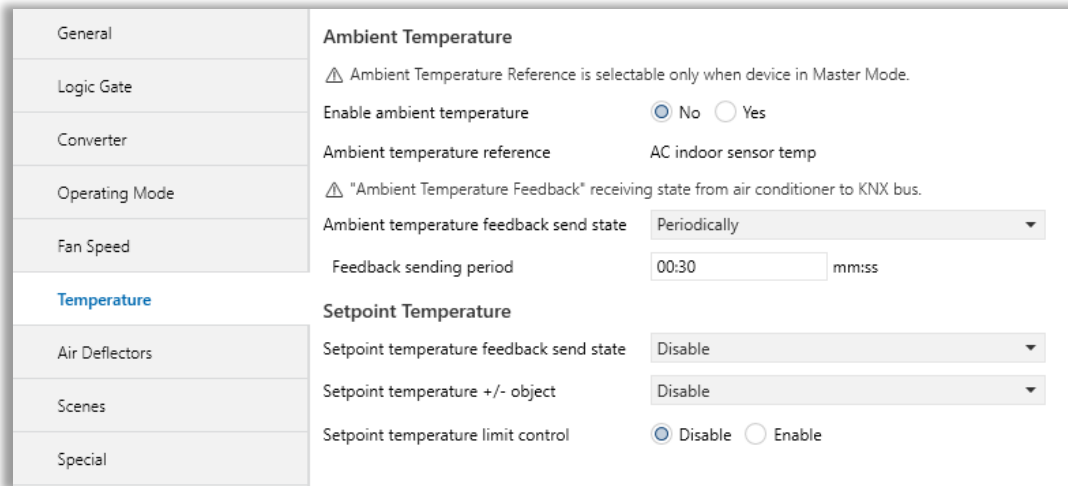

Fig. 16: Temperature Configuration Parameter Page

***Ambient Temperature:***

The air conditioner internal unit can display the temperature information via the "Feedback Indoor Temperature" object. However, it is also possible to receive the measurement of the measured ambient temperature from KNX by enabling the parameter "Indoor Temperature from KNX".

**Enable ambient temperature:**

When this parameter has not enabled, air conditioner read ambient temperature from indoor unit sensor and sends sensor value to KNX bus according to state of "Ambient temperature feedback send state" parameter.

When the parameter has enabled, temperature reference can selected as "KNX bus".

"KNX bus" selection allow to send room temperature to air conditioner over KNX bus.

**Special Note**



If Gateway's communication role on communication port is selected as Slave in General Page, "Ambient temperature reference" can not select "KNX bus". At this case air conditioner can take ambient reference from indoor unit or wired remote controller.

## Special Note



When the “Enable ambient temperature” parameter has enabled if there is no ambient temperature coming from KNX bus through 5 mins, the device select ambient temperature reference as “AC indoor sensor temp” until ambient temperature value sends over KNX again. Temperature value readed from indoor unit can be observed in KNX bus.

### *Setpoint Temperature:*

“Setpoint Temperature Control” object is always enable. Feedback of this object can be disabled or enabled via “Setpoint temperature feedback send state” parameter. The temperature sended to air conditioner can be observed via “Setpoint temperature feedback send state” parameter as Periodically, On change or both condition.

Via the parameter “Limits for setpoint control,” it is possible to enable a range for the setpoint to be modified. By enabling this option, the minimum and maximum setpoints available to send via KNX will be defined in the parameters “Setpoint lower limit” and “Setpoint higher limit”. By disabling this option, per default, the lower and higher limits will be limits of the air condition unit.

Via the object “Setpoint Temperature +/-” the setpoint temperature can be modified via a 1-bit object as follow:

- By sending “Up” (Value 0) or “Increase” (Value 1): The setpoint temperature will be increased by steps of 1°C until air condition unit limit or defined higher limit value.
- By sending “Down” (Value 1) or “Decrease” (Value 0): The setpoint temperature will be decreased by steps of 1°C until the air condition unit lower the limit value.

## Important Notes



- **Lowest cooling temperature value is 16 degrees.**
- **Highest heating temperature value is 30 degrees.**
- **Temperature setting is not available in the "Fan" mode.**

## Special Notes



When the “Setpoint temperature limit control” parameter has enabled, It only valid while using communication object. This parameter does not valid setpoint temperature defined in scene or others.

### 3.7.1. Parameters List

PARAMETERS	DESCRIPTION	VALUES
Enable ambient temperature	<p><b>No</b> Ambient temperature reference has selected from indoor unit sensor.</p> <p><b>Yes</b> Ambient temperature reference can be selected as “AC Indoor Sensor”, “KNX bus”.</p>	<p><b>No</b></p> <p>Yes</p>
Ambient temperature reference	<p><b>AC Indoor Sensor</b> Ambient temperature reference has selected from indoor unit sensor.</p> <p><b>KNX bus</b> Ambient temperature supplied from KNX.</p>	<p><b>AC Indoor Sensor</b></p> <p>KNX bus</p>
> Ambient temperature feedback send state <sup>1,2</sup>	<p>This parameter enables the sending of internal temperature value information.</p> <p><b>Disabled:</b> Temperature information is not sent. <b>Periodically:</b> Temperature information is sent periodically. <b>On change:</b> Temperature information is sent when there is a change in the temperature value. <b>Periodically and on change:</b> Temperature information is sent periodically and when there is a change in the temperature value.</p>	<p><b>Disable</b></p> <p>Periodically</p> <p>On change</p> <p>Periodically and on change</p>
> Feedback sending period <sup>2,3</sup>	<p>This parameter sets the sending period of the internal temperature value in seconds.</p>	<p>00:05 ...00:30... 04:15</p>
Setpoint temperature feedback send state	<p>This parameter allows the setpoint temperature sent to the air conditioner or the current setpoint temperature to be sent to the KNX line.</p> <p><b>Disabled:</b> Temperature information is not sent. <b>Periodically:</b> Temperature information is sent periodically. <b>On change:</b> Temperature information is sent when there is a change in the temperature value. <b>Periodically and on change:</b> Temperature information is sent periodically and when there is a change in the temperature value.</p>	<p><b>Disable</b></p> <p>Periodically</p> <p>On change</p> <p>Periodically and on change</p>

> <b>Feedback sending period</b> <sup>4</sup>	This parameter sets the sending period of the setpoint temperature value in seconds.	<b>00:05 .. 04:15</b>
<b>Setpoint temperature +/- object</b>	<p>This parameter enables to change of the desired temperature value as +/- with the 1-bit object.</p> <p><b>Normal (0-Decrease;1-Increase):</b> Setpoint temperature value increases when send "1"</p> <p><b>Inverted (0-Up;1-Down):</b> Setpoint temperature value increases when send "0"</p>	<p><b>Disable</b></p> <p>Normal</p> <p>Inverted</p>
<b>Setpoint temperature limit control</b>	This parameter enables limits for the setpoint temperature value.	<p><b>Disable</b></p> <p>Enabled</p>
> <b>Setpoint temperature lower limit</b> <sup>5</sup>	This parameter activates a lower limit for the setpoint temperature value.	<b>18...25</b>
> <b>Setpoint temperature higher limit</b> <sup>5</sup>	This parameter activates a higher limit for the setpoint temperature value.	<b>20...29</b>

<sup>1</sup> This parameter is only visible when the parameter "Enable ambient temperature" is set to "No".

<sup>2</sup> This parameter is only visible when the parameter "Ambient temperature reference" is set to "AC indoor sensor".

<sup>3</sup> This parameter is only visible when the parameter "Ambient temperature feedback send state" is set to "Periodically" or "Periodically and on change".

<sup>4</sup> This parameter is only visible when the parameter "Setpoint temperature feedback send state" is set to "Periodically" or "Periodically and on change".

<sup>5</sup> This parameter is only visible when the parameter "Setpoint temperature limit control" is set to "Enabled".

### 3.8. Scenes

On this parameter page, up to 5 different scenarios can be configured. Each scene functions are identical and the configuration of each scene permits:

- The number of scenes (Between 1-64) can be assigned.
- The air condition unit's on/off values can be set.
- The air condition unit's AC mode can be configured.
- Fan levels of the related scene can be specified.
- Vane positions of the related scene can be specified.
- The setpoint temperature can be set of the scene.
- The scene can be stored by enabling the storage function.
- Delay time can be specified for starting the scene.

General	SCENE 1	<input type="radio"/> Disable <input checked="" type="radio"/> Enable
Logic Gate	Number	1
Converter	Ac On/Off	AC Off
Operating Mode	Ac mode	Fan
Fan Speed	Ac fan speed	Auto
Temperature	Ac setpoint temperature (°C)	20
Air Deflectors	Storage function	<input checked="" type="radio"/> Disable <input type="radio"/> Enable
	Delay	00:05 mm:ss
	Activation object	<input checked="" type="radio"/> Disable <input type="radio"/> Enable
<b>Scenes</b>		
Special	SCENE 2	<input checked="" type="radio"/> Disable <input type="radio"/> Enable
	SCENE 3	<input checked="" type="radio"/> Disable <input type="radio"/> Enable
	SCENE 4	<input checked="" type="radio"/> Disable <input type="radio"/> Enable
	SCENE 5	<input checked="" type="radio"/> Disable <input type="radio"/> Enable

Fig. 17: Scenes Configuration Parameter Page

Via the object "Scene", telegrams that contains the call or store functions of a scene are sent. Up to 1...64 scenario numbers can be selected for 5 scenarios via a single group address. The scenario number telegram must match the pre-configured scenario number in the parameters.

The scene number (1-64), is used to recall the scene via the corresponding object. For storage of the scene, the value sent via the object "Scene" must be 128+scene number. The recall of each scene can be delayed whether a time delay has been previously defined in the parameter window.

#### Special Notes



After ETS programming, the scene values parameterized for the output concerned will be overwritten into the gateway. It means that any change made by the user will be deleted. Therefore, it is important, before any maintenance, to know the previous scene configuration and whether the user wants to keep operating with that configuration.

## 3.8.1. Parameters List

PARAMETERS	DESCRIPTION	VALUES
Scene X	This parameter is used to enable or disable the related scenario.	<b>Disable</b> Enable
> Number	This parameter is used to specify the scene number of the corresponding scene.	1...64
> AC On/Off	This parameter is used to determine the on/off status of the air condition unit for the selected scenario.	<b>AC Off</b> AC On No Change
> AC mode	This parameter is used to specify the mode of the air condition unit for the selected scenario.	Auto Heating Cooling <b>Fan</b> Dry No Change
> AC Fan level	This parameter is used to specify the fan level of the air condition unit for the selected scenario.	<b>Auto</b> Level 1 Level 2 Level 3 Level 4 Level 5 No Change
> AC setpoint temperature(°C)	This parameter is used to specify the setpoint temperature of the selected scenario.	18°C...29°C
> Storage function	This parameter is used to save the selected scenario.	<b>Disable</b> Enable
> Delay	This parameter is used to set a delay time for starting the selected scene.	<b>00:05</b> ... 04:15
> Activation object	This parameter is used to enable or disable the activation object to activate the scenario.	<b>Disable</b> Enable

### 3.9. Special

In this section, special functionalities of the LG/Beko/Arcelik AC - KNX Gateway are described. The gateway has 4 different functions for special purposes. Each of them is explained in separate subtitles.

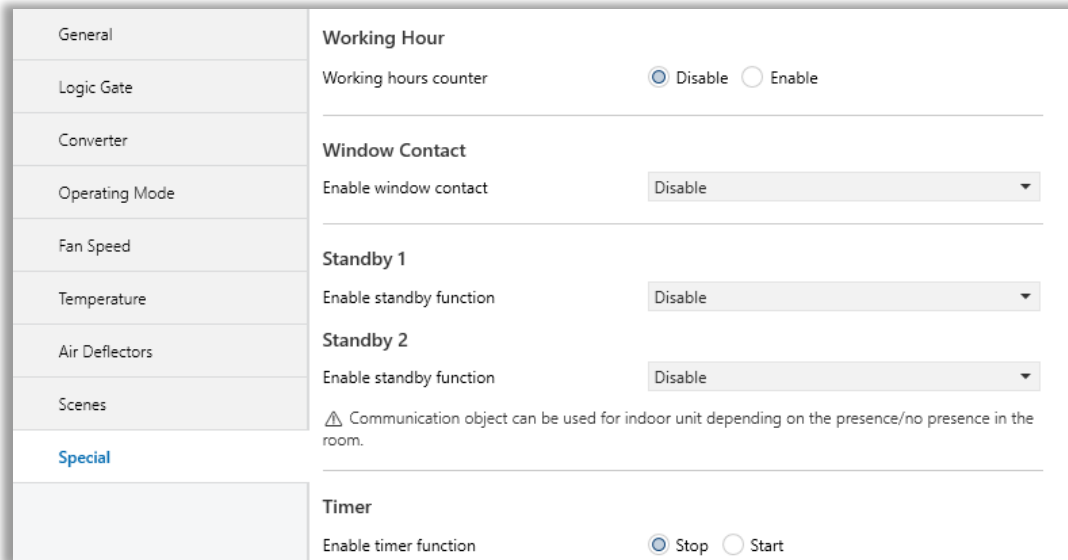

Fig. 18: Special Configuration Parameter Page

**Working Hour.** This function is used to know the air conditioner’s operating hour as “ON” position. When the “ON” status of the air condition unit is counted for one hour, the object value increases. The counter is available to create an alert to warn the user after the desired time later. The counter can be reset via the “Reset Hours Counter” object.

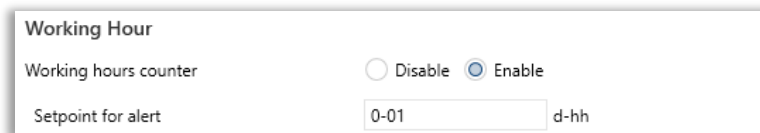

Fig. 19: Working Hour Configuration Parameter Page

**Window Contact.** This function is used for window contacts to determine the operation type when the window contacts are open or close. When the “window is open” information is received, it is possible to switch off the air condition unit or activate any predefined scene. However, it is possible to specify a delay time for the operation type to be started or to restrict the On / Off action of the air condition unit. After incoming “window contacts are closed” information, the behaviour of the air condition unit can be selected as one of the predefined scenarios, OFF or the previous state of this function.

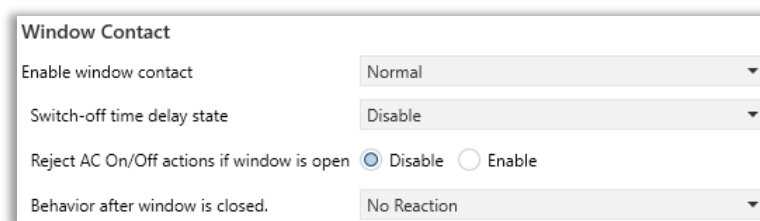

Fig. 20: Window Contact Configuration Parameter Page

**Standby Function:** This function is used to activate the standby modes for the air condition unit to determine the operation type for the standby modes. During standby function, it is possible to make setpoint shifting, activate any predefined scene or switch off the air condition unit. However, it is possible to specify delay time for operation type to be started or to reject modifications for the air condition unit during standby function. After incoming standby function stop information, the behaviour of the air condition unit can be selected as one of scenario, off or the previous state. Additionally, a secondary standby function is available and the same parameters and object are valid for the secondary standby function. If Standby function is enabled, any command received from the KNX Bus will stop the Standby Function.

Standby 1	
Enable standby function	Start-1;Stop-0
Standby function delay state	Disable
Behavior during standby function	Setpoint Temp Shift
Setpoint temperature shifting state	Disable
Reject modifications during standby	<input checked="" type="radio"/> Disable <input type="radio"/> Enable
Behavior after standby function	No Reaction

Fig. 21: Standby X Configuration Parameter Page

**Timer Function:** The timer function switches off the air condition unit after a defined time. Polarity and durations can be determined via sub-parameters of this function. The timer function is also retriggerable and when timer retrigger is enabled, the timer restarts itself for counting for switch off the air condition unit.

Timer	
Enable timer function	<input type="radio"/> Stop <input checked="" type="radio"/> Start
Polarity	<input checked="" type="radio"/> Normal <input type="radio"/> Inverted
Timer duration state	<input checked="" type="radio"/> Via parameter <input type="radio"/> Via Communication Object
Timer duration	01:00 hh:mm
Timer retriggerable	<input checked="" type="radio"/> No <input type="radio"/> Yes

Fig. 22: Timer Configuration Parameter Page

## 3.9.1. Parameters List

PARAMETERS	DESCRIPTION	VALUES
Working Hour	This parameter is used to enable or disable the working hours counter function.	<b>Disable</b> Enable
> Setpoint for alert <sup>1</sup>	This parameter is used to set a setpoint alarm point for the working hours counter of the air conditioner unit.	<b>0-01</b> ... 9-23 d-hh
Enable window contact	This parameter is used to enable or disable the air conditioner unit's window contact function. <b>Normal:</b> 0-Opened;1-Closed <b>Inverted:</b> 0-Closed;1-Opened	<b>Disable</b> Normal Inverted
> Switch-off time delay state <sup>2</sup>	This parameter is used to specify the switch-off time delay that is sent via parameter or communication object.	<b>Disable</b> Via parameter Via communication object
> Switch-off time delay <sup>2,3</sup>	This parameter is used to set delay time in minutes to switch off the air conditioner.	<b>00:01</b> ... 04-15 hh:mm
> Reject AC On/Off actions if window is open <sup>2</sup>	This parameter is used to reject on & off actions of the air conditioner unit's when the window is opened.	<b>Disable</b> Enable
> Behaviour after window is closed. <sup>2</sup>	This parameter is used to specify the behaviour after window is closed. For instance, one of the configured scenarios can be operated, the conditioner unit is turned off or the last state is maintained.	<b>No Reaction</b> Last State AC ON AC OFF Scene
> After window is closed scene. <sup>2,4</sup>	This parameter is used to activate defined scene if "Behaviour after window is closed" parameter is selected as "Scene"	<b>Scene 1</b> Scene 2 Scene 3 Scene 4 Scene 5

<p><b>Enable standby function</b></p>	<p>This parameter is used to enable or disable the standby function.</p> <p><b>Occupied-1;Not occupied-0:</b> According to occupied or not occupied status, configurations can be made. This can be used for indoor unit depending on the presence/ no presence in the room.</p> <p><b>Start-1;Stop-0:</b> This function is used in order to activate standby function.</p>	<p><b>Disabled</b></p> <p>Occupied-1;Not occupied-0</p> <p>Start-1;Stop-0</p>
<p>&gt; <b>Standby function delay state<sup>5</sup></b></p>	<p>This parameter is used to specify the standby function delay that is sent via parameter or communication object.</p>	<p><b>Disable</b></p> <p>Via parameter</p> <p>Via communication object</p>
<p>&gt; <b>Standby function delay<sup>6</sup></b></p>	<p>This parameter is used to set a delay time in minutes for the standby function.</p>	<p><b>00:01 ... 04-15 hh:mm</b></p>
<p>&gt; <b>Behaviour during standby function<sup>5</sup></b></p>	<p>This parameter is used to configure the behaviour during the standby function. For instance, one of the configured scenarios can be operated, the conditioner unit is turned off or the last state is maintained.</p>	<p><b>Setpoint shifting</b></p> <p>Off</p> <p>Scene</p>
<p>&gt; <b>Standby function scene<sup>6</sup></b></p>	<p>This parameter is used to activate defined scene if “Behaviour during standby function” parameter is selected as “Scene”</p>	<p>Scene 1</p> <p>Scene 2</p> <p>Scene 3</p> <p>Scene 4</p> <p>Scene 5</p>
<p>&gt; <b>Setpoint temperature shifting state<sup>7</sup></b></p>	<p>This parameter is used to specify the setpoint shifting that is sent via parameter or communication object.</p>	<p><b>Disable</b></p> <p>Via parameter</p> <p>Via communication object</p>
<p>&gt; <b>Setpoint temperature shifting (°C)<sup>8</sup></b></p>	<p>This parameter is used to set the setpoint shifting temperature value.</p>	<p>0...5</p>
<p>&gt; <b>Reject modifications during standby function<sup>5</sup></b></p>	<p>This parameter is used to enable or disable the reject modifications during the standby function. If this parameter is enabled, no modifications can be allowed in standby mode. User can not sends command to air conditioner.</p>	<p><b>Disable</b></p> <p>Enable</p>

<p>&gt; <b>Behaviour after standby function<sup>5</sup></b></p>	<p>This parameter is used to configure the behaviour during the standby function. For instance, one of the configured scenarios can be operated, the conditioner unit is turned off or the last state is maintained.</p>	<p><b>No reaction</b></p> <p>Last state</p> <p>AC ON</p> <p>AC OFF</p> <p>Scene</p>
<p>&gt; <b>Standby function scene<sup>6</sup></b></p>	<p>This parameter is used to activate defined scene if “Behaviour after standby function” parameter is selected as “Scene”</p>	<p>Scene 1</p> <p>Scene 2</p> <p>Scene 3</p> <p>Scene 4</p> <p>Scene 5</p>
<p><b>Enable timer function</b></p>	<p>This parameters is used for start or stop timer function.</p>	<p><b>Stop</b></p> <p>Start</p>
<p>&gt; <b>Polarity<sup>9</sup></b></p>	<p>This parameter is used to specify the polarity of enabling command the timer function.</p> <p><b>Normal:</b> 0-Stop; 1-Start <b>Inverted:</b> 0-Start; 1-Stop</p>	<p><b>Normal</b></p> <p>Inverted</p>
<p>&gt; <b>Timer duration state<sup>9</sup></b></p>	<p>This parameter is used to specify the timer duration that is sent via parameter or communication object.</p>	<p><b>Via parameter</b></p> <p>Via communication object</p>
<p>&gt; <b>Timer duration<sup>10</sup></b></p>	<p>This parameter is used to set delay time in minutes for the timer function.</p>	<p><b>00:01... 23:59 hh:mm</b></p>
<p>&gt; <b>Timer retriggerable<sup>9</sup></b></p>	<p>This parameter is used to restart the timer.</p>	<p><b>No</b></p> <p>Yes</p>

<sup>1</sup> This parameter is only visible when the parameter “Working Hour” is set to “Enable”.

<sup>2</sup> This parameter is only visible when the parameter “Enable window contact” is set to “Normal” or “Inverted”.

<sup>3</sup> This parameter is only visible when the parameter “Switch-off time delay state” is set to “Via parameter”.

<sup>4</sup> This parameter is only visible when the parameter “Behaviour after window is closed” is set to “Scene”.

<sup>5</sup> This parameter is only visible when the parameter “Enable standby function” is set to “Occupied-1;Not occupied-0” or “Start-1;Stop-0”.

<sup>6</sup> This parameter is only visible when the parameter “Behaviour during standby function” is set to “Scene”.

<sup>7</sup> This parameter is only visible when the parameter “Behaviour during standby function” is set to “Setpoint shifting”.

<sup>8</sup> This parameter is only visible when the parameter “Setpoint temperature shifting state” is set to “Via parameter”.

<sup>9</sup> This parameter is only visible when the parameter “Enable timer function” is set to “Start”.

<sup>10</sup> This parameter is only visible when the parameter “Timer duration state” is set to “Via parameter”.

## 4. ETS Objects List & Descriptions

The Interra LG/Beko/Arcelik AC - KNX Gateway can communicate via the KNX bus line. In this section, the group objects of the Interra LG/Beko/Arcelik Gateway are described.

ETS group objects are divided into 10 main parts, and these are:

- ❖ **General** - General group objects to the LG/Beko/Arcelik Gateway.
- ❖ **Logic Gate** - These objects are related to logic gate parameters.
- ❖ **Converter** - These objects are related to converter parameters.
- ❖ **Operating Mode** - These objects are related to operating mode parameters.
- ❖ **Fan** - These objects are related to fan parameters.
- ❖ **Air Deflectors** - These objects are related to air deflector parameters.
- ❖ **Temperature** - These objects are related to temperature parameters.
- ❖ **Scenes**- These objects are related to scenes parameters.
- ❖ **Special** - These objects are related to special functions.

### Special Note



**Due to the flexible ETS configurations feature, some group objects are dynamic and they are only visible if the related parameters are activated in the application program.**

All of the group objects of Interra LG/Beko/Arcelik AC - KNX Gateway are listed below. You can quickly browse through this table to get the functional capabilities of the Interra LG/Beko/Arcelik Gateway.

The detailed functions of group objects are described in different topics.

No	Name	Function	DTP Type	Length	Flags				
					C	R	W	T	U
1	Alive Beacon	Alive Beacon	1.002	1 Bit	X			X	
2,7, 12,17	Logic X – Input 1	Logic Input	1.002	1 Bit	X	X	X		
3,8, 13,18	Logic X – Input 2	Logic Input	1.002	1 Bit	X	X	X		
4,9, 14,19	Logic X – Input 3	Logic Input	1.002	1 Bit	X	X	X		
5,10, 15,20	Logic X – Input 4	Logic Input	1.002	1 Bit	X	X	X		
6,11, 16,21	Logic X – Output	Logic Output	1.002	1 Bit	X	X		X	
22,23, 24,25/ 30,31, 32,33/ .... 78,79, 80,81	Converter X - Input	Converter Input	1.006	1 Bit	X	X	X		
			2.006	2 Bit	X	X	X		
			5.010	1 Byte	X	X	X		
			7.001	2 Bytes	X	X	X		
26,27, 28,29/ 34,35, 36,37/ .... 78,79, 80,81	Converter X - Output	Converter Output	1.006	1 Bit	X	X	X	X	
			2.006	2 Bit	X	X	X	X	
			5.010	1 Byte	X	X	X	X	
			7.001	2 Bytes	X	X	X	X	
86	OnOff	0-Off ;1-On	1.001	1 Bit	X		X		
87	OnOff_Feedback	0-Off;1-On	1.001	1 Bit	X	X		X	
88	Operating_Mode	0-Auto;1-Heat;3-Cool;9-Fan;14-Dry	20.105	1 Byte	X		X		
89	Operating_Mode_Feedback	0-Auto;1-Heat;3-Cool;9-Fan;14-Dry	20.105	1 Byte	X	X		X	
90	Mode Cool/Heat	0-Cool;1-Heat	1.100	1 Bit	X		X		
	Mode Heat/Cool	0-Heat;1-Cool	1.100	1 Bit	X		X		
91	Mode Cool/Heat Feedback	0-Heat;1-Cool	1.100	1 Bit	X	X		X	
	Mode Heat/Cool Feedback	0-Cool;1-Heat	1.100	1 Bit	X	X		X	
92	Mode Heating_Percentage	0%-Off;1%-100%-On+Heat	5.001	1 Byte	X		X		
93	Mode Cooling_Percentage	0%-Off;1%-100%-On+Cool	5.001	1 Byte	X		X		
94	Mode Auto	1-Set AUTO mode	1.002	1 Bit	X		X		
95	Mode Auto Feedback	1-AUTO mode	1.002	1 Bit					
96	Mode Heat	1-Set HEAT mode	1.002	1 Bit	X		X		
97	Mode Heat Feedback	1-HEAT mode	1.002	1 Bit	X	X		X	
98	Mode Cool	1-Set COOL mode	1.002	1 Bit	X		X		
99	Mode Cool Feedback	1-COOL mode	1.002	1 Bit	X	X		X	
100	Mode Fan	1-Set FAN mode	1.002	1 Bit	X	X			
101	Mode Fan Feedback	1-FAN mode	1.002	1 Bit	X	X		X	
102	Mode Dry	1-Set DRY mode	1.002	1 Bit	X		X		
103	Mode Dry Feedback	1-DRY mode	1.002	1 Bit	X	X		X	
104	Mode +/-	0-Up;1-Down	1.008	1 Bit	X		X		
		0-Decrease;1-Increase	1.008	1 Bit	X		X		
105	Operating Mode Text Feedback	Text Feedback	16.001	14 Bytes	X	X		X	

106	Fan Speed Enumerated	0-Auto;1-Speed1;...5-Speed5;	5.100	1 Byte	X		X		
	Fan Speed Scaling	Threshold Defined in Parameter	5.001	1 Byte	X		X		
107	Fan Speed Scaling Feedback	% Percentage value	5.100	1 Byte	X	X		X	
	Fan Speed Enumerated Feedback	0-Auto;1-Speed1;...5-Speed5;	5.100	1 Byte	X	X		X	
108	Fan Speed 1 Control	1-Set Fan Speed 1	1.002	1 Byte	X		X		
109	Fan Speed 1 Feedback	1-Fan Speed 1	1.002	1 Bit	X	X		X	
110	Fan Speed 2 Control	1-Set Fan Speed 2	1.002	1 Bit	X		X		
111	Fan Speed 2 Feedback	1-Fan Speed 2	1.002	1 Bit	X	X		X	
112	Fan Speed 3 Control	1-Fan Speed Auto	1.002	1 Bit	X		X		
113	Fan Speed 3 Feedback	1-Fan Speed 3	1.002	1 Bit	X	X		X	
114	Fan Speed 4 Control	1-Set Fan Speed 4	1.002	1 Bit	X		X		
115	Fan Speed 4 Feedback	1-Fan Speed 4	1.002	1 Bit	X	X		X	
116	Fan Speed 5 Control	1-Set Fan Speed 5	1.002	1 Bit	X		X		
117	Fan Speed 5 Feedback	1-Fan Speed 5	1.002	1 Bit	X	X		X	
118	Fan Speed 6 Control	1-Set Fan Speed 6	1.002	1 Bit	X		X		
119	Fan Speed 6 Feedback	1-Fan Speed 6	1.002	1 Bit	X	X		X	
120	Fan Speed Auto Control	1-Set Fan Speed Auto	1.002	1 Bit	X		X		
121	Fan Speed Auto Feedback	1-Fan Speed Auto	1.002	1 Bit	X	X		X	
		0-Decrease;1-Increase	1.007	1 Bit	X		X		
122	Fan Speed +/-	0-Up;1-Down	1.008	1 Bit	X		X		
		Fan Speed Text	16.001	14 Bytes	X	X		X	
123	Fan Speed Text Feedback	Fan Speed Text	16.001	14 Bytes	X	X		X	
124	Setpoint Temperature Control	°C	9.001	1 Bit	X		X		
125	Setpoint Temperature Feedback	°C	9.001	1 Bit	X	X		X	
126	Setpoint Temperature +/-	0-Decrease;1-Increase	1.007	1 bit	X		X		
		0-Up;1-Down	1.008	1 Bit	X		X		
127	Ambient Temperature	°C	9.001	2 Bytes	X		X		
128	Ambient Temperature Feedback	°C	9.001	2 Bytes	X		X	X	
129	Air Deflector Broadcast Value	0-Swing;1-Pos1;...5-Pos5		1 Byte	X		X		
		0-Up;1-Down	1.008	1 Bit	X		X		
130	Air Deflector +/-	0-Decrease;1-Increase	1.007	1 Bit	X		X		
		0-Swing;1-Pos1;...5-Pos5		1 Byte	X	X		X	
131	Air Deflector Feedback	0-Swing;1-Pos1;...5-Pos5		1 Byte	X	X		X	
132	Window Contact Status	0-Opened;1-Closed	1.009	1 Bit	X	X	X	X	
		0-Closed;1-Opened	1.019	1 Bit	X	X	X	X	
133	Window Contact Off Delay	Values are accepted according to the data type of 20.013	20.013	1 Byte	X		X		
134	Standby 1 Function	0-Stop;1-Start	1.010	1 Bit	X		X		
		0-Not occupied;1-Occupied	1.018	1 Bit	X		X		
135	Standby 1 Feedback	0-Stop;1-Start		1 Bit	X	X		X	
		0-Not occupied;1-Occupied	1.018	1 Bit	X	X		X	
136	Standby 1 Delay	Values are accepted according to the data type of 20.013	20.013	1 Byte	X		X		
137	Standby 1 Setpoint Shifting	°C	9.001	2 Bytes	X		X		
138	Standby 2 Function	0-Not occupied;1-Occupied	1.018	1 Bit	X		X		
		0-Start;1-Stop	1.010	1 Bit	X		X		
139	Standby 2 Feedback	0-Not occupied;1-Occupied	1.018	1 Bit	X	X		X	

		0-Stop;1-Start	1.010	1 Bit	X	X		X	
140	Standby 2 Delay	Values are accepted according to the data type of 20.013	20.013	1 Byte	X		X		
141	Standby 2 Setpoint Shifting	°C	9.001	2 Bytes	X		X	X	
142	Timer State	0-Stop;1-Start	1.010	1 Bit	X		X	X	
		0-Start;1-Stop	1.010	1 Bit	X		X	X	
143	Timer State Feedback	0-Start;1-Stop	1.010	1 Bit	X	X		X	
		0-Stop;1-Start	1.010	1 Bit	X	X		X	
144	Timer Duration	Values are accepted according to the data type of 20.013	20.013	1 Byte	X	X		X	
145	Scene	0-63 (Execute 1-64); 128-191 (Storage 1-64)	18.001	1 Byte	X	X		X	
146	Scene 1 Run	0-Nothing;1-Run Scene	1.002	1 Bit	X		X	X	
147	Scene 1 Storage	0-Nothing;1-Storage Scene	1.002	1 Bit	X	X		X	
148	Scene 2 Run	0-Nothing;1-Run Scene	1.002	1 Bit	X	X		X	
149	Scene 2 Storage	0-Nothing;1-Storage Scene	1.002	1 Bit	X	X		X	
150	Scene 3 Run	0-Nothing;1-Run Scene	1.002	1 Bit	X		X		
151	Scene 3 Storage	0-Nothing;1-Storage Scene	1.002	1 Bit	X		X	X	
152	Scene 4 Run	0-Nothing;1-Run Scene	1.002	1 Bit	X		X	X	
153	Scene 4 Storage	0-Nothing;1-Storage Scene	1.002	1 Bit	X		X	X	
154	Scene 5 Run	0-Nothing;1-Run Scene	1.002	1 Bit	X		X	X	
155	Scene 5 Storage	0-Nothing;1-Storage Scene	1.002	1 Bit	X		X	X	
156	Current Scene Feedback	1-64:Current Scene	17.001	1 Byte	X	X		X	
157	Device Control Locking	0-Enable;1-Disable	1.003	1 Bit	X	X		X	
158	Error Alarm Feedback	0-No Alarm;1-Alarm	1.005	1 Bit	X	X		X	
159	Error Code Feedback	Error Code Information		2 Bytes	X	X		X	
160	Error Code Text Feedback	Error Text Information	16.001	14 Bytes	X	X		X	
161	Working Hour Counter Feedback	Working Hours Counter Feedback	13.100	4Bytes	X	X		X	
162	Working Hour Alert Feedback	0-No Alarm;1-Alarm	1.005	1Bit	X	X		X	
163	Reset Hours Counter	0-No Action;1-Reset	1.015	1Bit	X		X		

## 4.1. General Objects

This section describes the "general" group objects and their properties. General group objects, as the name suggests, indicate the general characteristics of the LG/Beko/Arcelik Gateway.

Object Number	Object Name	Function	Type	Flags
1	Alive beacon	1:True/0:False	1 bit	CT

This object is used to monitor the presence of the device on the KNX bus line regularly. However, monitoring telegrams can be sent cyclically on the KNX bus line. This object appears only the "Alive beacon state" parameter is enabled.

DPT: 1.002 (Boolean)

86	OnOff	1:On/0:Off	1 bit	CW
----	-------	------------	-------	----

This object is used to turn the Gateway on or off. Also, this object is visible permanently. If you associate the desired group address, Gateway can be controlled with On and Off.

DPT: 1.001 (Switch)

87	OnOff_Feedback	1:On/0:Off	1 bit	CRT
----	----------------	------------	-------	-----

This object is used to check the status of the air conditioner unit. Also, this object is visible permanently. If you associate the desired group address, Gateway's ON and OFF status can be monitored.

DPT: 1.001 (Switch)

158	Error Alarm Feedback	1:Alarm/0:No Alarm	1 bit	CRT
-----	----------------------	--------------------	-------	-----

This object is used to check the status of the air conditioner unit's error alarm. Also, this object is visible permanently. If there is an error alarm and a group address is associated with the corresponding object, the alarm can be monitored.

DP: 1.005 (alarm)

159	Error Code Feedback	Error Code Information	2 bytes	CRT
-----	---------------------	------------------------	---------	-----

This object is used to give information about the error codes. This functionality allows sending messages to the KNX bus informing about errors. Errors management handles air conditioner unit error codes as well as any communication errors that may arise. For more detailed information check the section APPENDIX.

<b>160</b>	<b>Error Code Text Feedback</b>	<b>Error Text Information</b>	<b>14 bytes</b>	<b>CRT</b>
------------	---------------------------------	-------------------------------	-----------------	------------

This object is used to give information about the 2 Byte error codes in string format.

DPT: 16.001 (Character String) (ISO 8859-1)

<b>157</b>	<b>Device Control Locking</b>	<b>1:Enabled / 0:Disabled 0:Enabled / 1:Disabled</b>	<b>1 bit</b>	<b>CRT</b>
------------	-------------------------------	--	--------------	------------

This object is used to lock the gateway device. When a value that predetermined from parameter is sent to this communication object, the gateway is locked. If a value is sent to the gateway via its communication objects, all values are ignored. For unlocking the gateway, a opposite value of determined from parameter must be sent.

DPT: 1.003 (Enable)

## 4.2. Logic Gate Objects

This section describes the "Logic Gate" group objects and their properties. Logic Gate group objects, as the name suggests, indicate the logical operations that can be made with LG/Beko/Arcelik Gateway.

Object Number	Object Name	Function	Type	Flags
2, 3, 4, 5, 7 8, 9, 10, 12 13, 14, 15, 17, 18, 19, 20	Logic X – Input 1 Logic X – Input 2 Logic X – Input 3 Logic X – Input 4	Logic Input	1 bit	CRW

This object is used to set the inputs of the logical gate to be used. Logical associations can be made over 1-bit values. The result is obtained according to the type of logical gate selected.

DPT: 1.002 (Boolean)

6, 11, 16, 21	Logic X – Output	Logic Output	1 bit	CRT
---------------	------------------	--------------	-------	-----

This object is used to obtain the result of the logical gate to be used. The output value of the logical gate is 1 bit. The result is obtained according to the type of logical gate selected.

DPT: 1.002 (Boolean)

### Special Notes



**This is a fully compatible KNX device that must be configured and setup using the standard KNX tool ETS. Up to 4 different logic gates can be selected. Each logic gate can be set independently.**

### 4.3. Converter Objects

This section describes the "Converter" group objects and their properties. Converter group objects are used to make mathematical operations and data converting from different types. Up to 8 different converters can be configured.

Object Number	Object Name	Function	Type	Flags
22,23,24,25/ 30,31,32,33/.... 78,79,80,81	Converter X – Input (1 Bit)	Converter Input	1 bit	CRW
	Converter X – Input (2 Bits)		2 bits	
	Converter X – Input (1 Byte)		1 byte	
	Converter X – Input (2 Bytes)		2 bytes	

This object is used to set the converter inputs to be used. The conversion processes can be made via 1 bit, 2 bit, 1 byte and 2-byte values. The result is obtained according to the input type of the selected converter.

DPT:

1 Bit (1.006 Binary Value)

2 Bits (2.006 Binary Value)

1 Byte (5.010 Counter Pulses (0...255))

2 Bytes (7.001 Pulses)

26,27,28,29/ 34,35,36,37/.... 78,79,80,81	Converter X – Output (1 Bit)	Converter Output	1 bit	CRWT
	Converter X – Output (2 Bits)		2 bits	
	Converter X – Output (1 Byte)		1 byte	
	Converter X – Output (2 Bytes)		2 bytes	

This object is used to obtain the result of the converter to be used. The output value of the converter can be 1 bit, 2-bit, 1 byte and 2 bytes. The result is obtained according to the configuration of the selected converter.

DPT:

1 Bit (1.006 Binary Value)

2 Bits (2.006 Binary Value)

1 Byte (5.010 Counter Pulses (0...255))

2 Bytes (7.001 Pulses)

## 4.4. Operating Mode Objects

This section describes the "Operating Mode" group objects and their properties. Heat, cool, dry, auto and fan mode communication objects are described. Also, simple heating-cooling mode and summer, winter, energy saver and power saver mode objects are clarified.

Object Number	Object Name	Function	Type	Flags
88	Operating_Mode	0-Auto;1-Heat;3-Cool;9-Fan;14-Dry	1 byte	CWRT

This object is used to set the operating modes of the air conditioner. You can select AUTO with 0, HEAT with 1, COOL with 3, FAN with 9, and DRY with 14.

DPT: 20.105 (HVAC Control Mode)

89	Operating_Mode_Feedback	0-Auto;1-Heat;3-Cool;9-Fan;14-Dry	1 byte	CRT
----	-------------------------	-----------------------------------	--------	-----

This object is used to monitor the status of the operating modes of the air conditioner. With value 0 the status is AUTO, value 1 the status is HEAT, with value 3 status is COOL, with value 9 the status is FAN and with value 14 the status is DRY can be understood.

DPT: 20.105 (HVAC Control Mode)

90	Mode Cool/Heat	0-Cool;1-Heat 0-Heat;1-Cool	1 bit	CW
----	----------------	--------------------------------	-------	----

This object is used to set the operating mode of the air conditioner unit. When selecting this option, the related 1-bit object will be enabled. It allows establishing the desired mode: Cool mode, writing the value "0" in the object and Heat mode, writing the value "1" or vice versa.

DPT: 1.100 (Cooling/Heating )

91	Mode Cool/Heat Feedback	0-Cool;1-Heat 0-Heat;1-Cool	1 bit	CRT
----	-------------------------	--------------------------------	-------	-----

This object is used to check the operating mode of the air conditioner unit.

DPT: 1.100 (Cooling/Heating )

92	Mode Heating_Percentage	0%-Off;1%-100%-On+Heat	1 byte	CW
----	-------------------------	------------------------	--------	----

This object is used to change operating mode to heat via incoming percentage value. It also provides compatibility with KNX thermostats that control the demand for heating or cooling by using percentage values. In these thermostats, the percentage demand is meant to be applied on a fluid valve of the heating/cooling system. If a non-zero value is received (>0%) the indoor unit will switch on to Heat mode.

DPT: 5.001 (Percentage (0..100%))

<b>93</b>	<b>Mode Cooling_Percentage</b>	<b>0%-Off;1%-100%-On+Cool</b>	<b>1 byte</b>	<b>CW</b>
-----------	--------------------------------	-------------------------------	---------------	-----------

This object is used to change operating mode to cool via incoming percentage value. It also provides compatibility with KNX thermostats that control the demand for heating or cooling by using percentage values. In these thermostats, the percentage demand is meant to be applied on a fluid valve of the heating/cooling system. If a non-zero value is received (>0%) the indoor unit will switch on to Cool mode.

DPT: 5.001 (Percentage (0..100%))

<b>94</b>	<b>Mode Auto</b>	<b>1-Set AUTO mode</b>	<b>1 bit</b>	<b>CW</b>
-----------	------------------	------------------------	--------------	-----------

This object is used to change the air conditioner's operating mode to auto mode via a 1-bit object individually. If the value 1 is sent over the 1-bit value, the air conditioning unit will switch to auto mode.

DPT: 1.002 (Boolean)

<b>95</b>	<b>Mode Auto Feedback</b>	<b>1-AUTO mode</b>	<b>1 bit</b>	<b>CRT</b>
-----------	---------------------------	--------------------	--------------	------------

This object is used to monitor the air condition unit status individually. If value 1 is received from this object, the operating mode is auto.

DPT: 1.002 (Boolean)

<b>96</b>	<b>Mode Heat</b>	<b>1-Set HEAT mode</b>	<b>1 bit</b>	<b>CW</b>
-----------	------------------	------------------------	--------------	-----------

This object is used to change the air conditioner's operating mode to heat mode via a 1-bit object individually. If the value 1 is sent over the 1-bit value, the air conditioning unit will switch to heat mode.

DPT: 1.002 (Boolean)

<b>97</b>	<b>Mode Heat Feedback</b>	<b>1-HEAT mode</b>	<b>1 bit</b>	<b>CRT</b>
-----------	---------------------------	--------------------	--------------	------------

This object is used to monitor the air condition unit status individually. If value 1 is received from this object, the operating mode is heating.

DPT: 1.002 (Boolean)

<b>98</b>	<b>Mode Cool</b>	<b>1-Set COOL mode</b>	<b>1 bit</b>	<b>CW</b>
-----------	------------------	------------------------	--------------	-----------

This object is used to change the air conditioner's operating mode to cool mode via a 1-bit object individually. If the value 1 is sent over the 1-bit value, the air conditioning unit will switch to cool mode.

DPT: 1.002 (Boolean)

<b>99</b>	<b>Mode Cool Feedback</b>	<b>1-COOL mode</b>	<b>1 bit</b>	<b>CRT</b>
-----------	---------------------------	--------------------	--------------	------------

This object is used to monitor the air condition unit status individually. If value 1 is received from this object, the operating mode is cool.

DPT: 1.002 (Boolean)

<b>100</b>	<b>Mode Fan</b>	<b>1-Set FAN mode</b>	<b>1 bit</b>	<b>CW</b>
------------	-----------------	-----------------------	--------------	-----------

This object is used to change the air conditioner's operating mode to fan mode via a 1-bit object individually. If the value 1 is sent over the 1-bit value, the air conditioning unit will switch to fan mode.

DPT: 1.002 (Boolean)

<b>101</b>	<b>Mode Fan Feedback</b>	<b>1-FAN mode</b>	<b>1 bit</b>	<b>CRT</b>
------------	--------------------------	-------------------	--------------	------------

This object is used to monitor the air condition unit status individually. If value 1 is received from this object, the operating mode is the fan.

DPT: 1.002 (Boolean)

<b>102</b>	<b>Mode Dry</b>	<b>1-Set DRY mode</b>	<b>1 bit</b>	<b>CW</b>
------------	-----------------	-----------------------	--------------	-----------

This object is used to change the air conditioner's operating mode to dry mode via a 1-bit object individually. If the value 1 is sent over the 1-bit value, the air conditioning unit will switch to dry mode.

DPT: 1.002 (Boolean)

<b>103</b>	<b>Mode Dry Feedback</b>	<b>1-DRY mode</b>	<b>1 bit</b>	<b>CRT</b>
------------	--------------------------	-------------------	--------------	------------

This object is used to monitor the air condition unit status individually. If value 1 is received from this object, the operating mode is dry.

DPT: 1.002 (Boolean)

<b>104</b>	<b>Mode +/-</b>	<b>0-Decrease;1-Increase</b>	<b>1 bit</b>	<b>CW</b>
------------	-----------------	------------------------------	--------------	-----------

This object changes between operating modes as +/- via 1-bit value. This object is used to switch between the operating modes of the air conditioning unit in a loop. If a continuous value is sent in the increasing direction, it follows the following sequence and returns to the beginning when reaches the last mode.

1:Increase : auto->heat->cool->fan->dry  
0:Decrease : dry -> fan -> cool -> heat->auto

DPT: 1.007 (Step)

<b>104</b>	<b>Mode +/-</b>	<b>0-Up;1-Down</b>	<b>1 bit</b>	<b>CWT</b>
------------	-----------------	--------------------	--------------	------------

This object changes between operating modes as +/- via 1-bit value. This object is used to switch between the operating modes of the air conditioning unit in a loop. If a continuous value is sent in the increasing direction, it follows the following sequence and returns to the beginning when reaches the last mode.

0:Up : auto->heat->cool->fan->dry  
1:Down : dry -> fan -> cool -> heat->auto

DPT: 1.008 (Up/Down)

105	Operating Mode Text Feedback	Text Feedback	14 bytes	CRT
-----	------------------------------	---------------	----------	-----

This object is used to monitor the operation mode of the air conditioning unit in text format via the KNX bus line. Naming can be made for each operating mode with a length of 14 bytes.

DPT: 16.001 (Character String (ISO 8859-1))

## 4.5. Fan Group Objects

In this section, fan group objects and their properties are described.

Object number	Object Name	Function	Type	Flags
106	Fan Speed Scaling	Threshold defined in parameter	1 byte	CW

This object is used to set fan speeds in percentages. 5 different fan speeds can be configured according to the specified threshold values. For example, select Fan speed 1 lower limit is 30% and Fan speed 2 lower limit is 55%. If a 45% value is sent over this object, fan speed will be fan1.

DPT: 5.001 (Percentage(0...100%))

107	Fan Speed Scaling Feedback	% Percentage value	1 byte	CRT
-----	----------------------------	--------------------	--------	-----

This object gives last value about communication object fan speed scaling percentage.

DPT: 5.001 (Percentage(0...100%))

106	Fan Speed Enumerated	0-Auto;1-Speed1;...6-Speed6	1 byte	CW
-----	----------------------	-----------------------------	--------	----

This object is used to determine the fan speed by selecting between 0-5 values. For example, if value 1 is sent, fan speed will be fan 1.

DPT: 5.001 (Fan Stage (0..255))

107	Fan Speed Enumerated Feedback	0-Auto;1-Speed1;...6-Turbo	1 byte	CRT
-----	-------------------------------	----------------------------	--------	-----

This object is used to receive current fan speed in between 0-5 values.

DPT: 5.001 (Fan Stage (0..255))

108	Fan Speed 1 Control	1-Set Fan Speed 1	1 bit	CW
-----	---------------------	-------------------	-------	----

This object is used to select fan speed 1 individually. If a value 1 is sent, the fan speed will be fan 1.

DPT: 1.002 (Boolean)

109	Fan Speed 1 Feedback	1-Fan Speed 1	1 bit	CRT
-----	----------------------	---------------	-------	-----

This object is used to monitor the fan speed 1 of the air conditioner.

DPT: 1.002 (Boolean)

110	Fan Speed 2 Control	1-Set Fan Speed 2	1 bit	CW
-----	---------------------	-------------------	-------	----

This object is used to select fan speed 2 individually. If a value 1 is sent, the fan speed will be fan 2.

DPT: 1.002 (Boolean)

<b>111</b>	<b>Fan Speed 2 Feedback</b>	<b>1-Fan Speed 2</b>	<b>1 bit</b>	<b>CRT</b>
------------	-----------------------------	----------------------	--------------	------------

This object is used to monitor the fan speed 2 of the air conditioner.

DPT: 1.002 (Boolean)

<b>112</b>	<b>Fan Speed 3 Control</b>	<b>1-Set Fan Speed 3</b>	<b>1 bit</b>	<b>CW</b>
------------	----------------------------	--------------------------	--------------	-----------

This object is used to select fan speed 3 individually. If a value 1 is sent, the fan speed will be fan 3.

DPT: 1.002 (Boolean)

<b>113</b>	<b>Fan Speed 3 Feedback</b>	<b>1-Fan Speed 3</b>	<b>1 bit</b>	<b>CRT</b>
------------	-----------------------------	----------------------	--------------	------------

This object is used to monitor the fan speed 3 of the air conditioner.

DPT: 1.002 (Boolean)

<b>114</b>	<b>Fan Speed 4 Control</b>	<b>1-Set Fan Speed 4</b>	<b>1 bit</b>	<b>CW</b>
------------	----------------------------	--------------------------	--------------	-----------

This object is used to select fan speed 4 individually. If a value 1 is sent, the fan speed will be fan 4.

DPT: 1.002 (Boolean)

<b>115</b>	<b>Fan Speed 4 Feedback</b>	<b>1-Fan Speed 4</b>	<b>1 bit</b>	<b>CRT</b>
------------	-----------------------------	----------------------	--------------	------------

This object is used to monitor the fan speed 4 of the air conditioner.

DPT: 1.002 (Boolean)

<b>116</b>	<b>Fan Speed 5 Control</b>	<b>1-Set Fan Speed 5</b>	<b>1 bit</b>	<b>CW</b>
------------	----------------------------	--------------------------	--------------	-----------

This object is used to select fan speed 5 individually. If a value 1 is sent, the fan speed will be fan 5.

DPT: 1.002 (Boolean)

<b>117</b>	<b>Fan Speed 5 Feedback</b>	<b>1-Fan Speed 5</b>	<b>1 bit</b>	<b>CRT</b>
------------	-----------------------------	----------------------	--------------	------------

This object is used to monitor the fan speed 5 of the air conditioner.

DPT: 1.002 (Boolean)

<b>118</b>	<b>Fan Speed 6 Control</b>	<b>1-Set Fan Speed 6</b>	<b>1 bit</b>	<b>CW</b>
------------	----------------------------	--------------------------	--------------	-----------

This object is used to select fan speed 6 individually. If a value 1 is sent, the fan speed will be fan 6.  
DPT: 1.002 (Boolean)

<b>119</b>	<b>Fan Speed 6 Feedback</b>	<b>1-Fan Speed 6</b>	<b>1 bit</b>	<b>CRT</b>
------------	-----------------------------	----------------------	--------------	------------

This object is used to monitor the fan speed 6 of the air conditioner.  
DPT: 1.002 (Boolean)

<b>120</b>	<b>Fan Speed Auto Control</b>	<b>1-Set Fan Speed Auto</b>	<b>1 bit</b>	<b>CW</b>
------------	-------------------------------	-----------------------------	--------------	-----------

This object is used to select fan speed Auto individually. If a value 1 is sent, the fan speed will be fan Auto. After this object is disabled, means value 0 is sent, fan speed returns the state before auto fan speed set.  
DPT: 1.002 (Boolean)

<b>121</b>	<b>Fan Speed Auto Feedback</b>	<b>1-Set Fan Speed Auto</b>	<b>1 bit</b>	<b>CRT</b>
------------	--------------------------------	-----------------------------	--------------	------------

This object is used to monitor the fan speed Auto of the air conditioner.  
DPT: 1.002 (Boolean)

<b>122</b>	<b>Fan Speed +/-</b>	<b>0-Decrease;1-Increase</b>	<b>1 bit</b>	<b>CW</b>
------------	----------------------	------------------------------	--------------	-----------

This object is used to change between fan speed levels with a 1-bit value. If a continuous value is sent in the increasing direction, it follows the following sequence. Additionally, if the “Loop the sequence” parameter is activated, increasing or decreasing that returns the mode to the beginning when it reaches the last mode.

1:Increase : auto->fan speed 1->fan speed 2->fan speed 3-> fan speed 4->fan speed 5  
0:Decrease : fan speed 5-> fan speed 4->Fan speed 3->fan speed 2->fan speed 1->auto

DPT: 1.007 (Step)

<b>122</b>	<b>Fan Speed +/-</b>	<b>0-Up;1-Down</b>	<b>1 bit</b>	<b>CW</b>
------------	----------------------	--------------------	--------------	-----------

This object is used to change between fan speed levels with a 1-bit value. If a continuous value is sent in the increasing direction, it follows the following sequence. Additionally, if the “Loop the sequence” parameter is activated, increasing or decreasing that returns the mode to the beginning when it reaches the last mode.

0:Up: auto->fan speed 1->fan speed 2->fan speed 3-> fan speed 4->fan speed 5  
1:Down: fan speed 5-> fan speed 4->Fan speed 3->fan speed 2->fan speed 1 ->auto

DPT: 1.008 (Up / Down)

---

<b>123</b>	<b>Fan Speed Text Feedback</b>	<b>Fan Speed Text</b>	<b>14 bytes</b>	<b>CRT</b>
------------	--------------------------------	-----------------------	-----------------	------------

---

This object is used to receive the air conditioner unit's fan speed status via text format. For each fan speed status up to 14 bytes are allowed to determine the name of the fan speeds.

DPT: 16.001 (Character String (ISO))

---

## 4.6. Temperature Group Objects

In this section, temperature group objects and their properties are described.

Object Number	Object Name	Function	Type	Flags
124	Setpoint Temperature Control	Temperature(Celsius)	2 bytes	CW

This object is used to modify the setpoint temperature to be sent to the AC indoor unit according to the desired value.

DPT: 9.001 (Temperature °C)

125	Setpoint Temperature Feedback	Temperature(Celsius)	2 bytes	CRT
-----	-------------------------------	----------------------	---------	-----

This object is used to monitor the air conditioner unit setpoint temperature from the KNX bus line.

DPT: 9.001 (Temperature °C)

126	Setpoint Temperature +/-	0-Decrease;1-Increase	1 bit	CW
-----	--------------------------	-----------------------	-------	----

This object is used to change the setpoint temperature by increasing or decreasing by a 1-bit value. If a continuous value is sent in the increasing direction, it is increased up to the highest temperature value. Likewise, if a continuous value is sent in the decreasing direction, it is decreased up to the lowest temperature value.

DPT: 1.007 (Step)

126	Setpoint Temperature +/-	0-Up;1:Down	1 bit	CW
-----	--------------------------	-------------	-------	----

This object is used to change the setpoint temperature by increasing or decreasing by a 1-bit value. If a continuous value is sent in the increasing direction, it is increased up to the highest temperature value. Likewise, if a continuous value is sent in the decreasing direction, it is decreased up to the lowest temperature value.

DPT: 1.008 (Up/Down)

127	Ambient Temperature	Temperature (Celsius)	2 bytes	CW
-----	---------------------	-----------------------	---------	----

This object is used to receive the KNX ambient temperature from the KNX bus line. This option only works when the Gateway operates in master mode.

DPT: 9.001 (Temperature °C)

128	Ambient Temperature Feedback	Temperature (Celsius)	2 bytes	CRT
-----	------------------------------	-----------------------	---------	-----

This object is used to read the ambient temperature that sended to air conditioner or readed from the air conditioner.

- When “Enable ambient temperature” parameter is selected “No” and “Ambient temperature feedback send state” is different from “Disable”, this object shows the ambient temperature readed from air conditioner indoor temperature sensor.
- When “Enable ambient temperature” parameter is selected “Yes”, this object shows the ambient temperature sended to air conditioner. If there is no ambient temperature coming from KNX bus through 5 mins, the device select ambient temperature reference as “AC indoor sensor temp” until ambient temperature value sends over KNX again. Temperature value readed from indoor unit can be observed in KNX bus.

DPT: 9.001 (Temperature °C)

## 4.7. Air Deflectors Group Objects

In this section, air deflectors group objects and their properties are described.

Object Number	Object Name	Function	Type	Flags
129	Air Deflector Broadcast Value	0-Swing;1-Pos1;...5-Pos5	1 byte	CW

This object is used to receive the current air deflector position in between 0-5 values.

130	Air Deflector +/-	0-Decrease ;1-Increase	1 bit	CW
-----	-------------------	------------------------	-------	----

This object is used to change between air deflector position levels with a 1-bit value. If a continuous value is sent in the increasing direction, it follows the following sequence. Additionally, if the “Loop the sequence” parameter is activated, increasing or decreasing that returns the mode to the beginning when it reaches the last mode.

1:Increase : Swing ->pos 1->pos 2->pos 3->pos 4->pos 5

0:Decrease : pos 5->pos 4->pos 3->pos 2->pos 1->Swing

DPT: 1.007 (Step)

130	Air Deflector +/-	0-Up;1-Down	1 bit	CW
-----	-------------------	-------------	-------	----

This object is used to change between air deflector position levels with a 1-bit value. If a continuous value is sent in the increasing direction, it follows the following sequence. Additionally, if the “Loop the sequence” parameter is activated, increasing or decreasing that returns the mode to the beginning when it reaches the last mode.

0:Up : Swing->pos 1->pos 2->pos 3->pos 4->pos 5

1:Down : pos 5->pos 4->pos 3->pos 2->pos 1->Swing

DPT: 1.008 (Up/Down)

131	Air Deflector Feedback	0-Swing;1-Pos1;...5-Pos5	1 byte	CRT
-----	------------------------	--------------------------	--------	-----

This object is used to receive the air conditioner unit's air deflector position status via 1 byte object.

## 4.8. Scene Group Objects

In this section, scene group objects and their properties are described.

Object Number	Object Name	Function	Type	Flags
145	Scene	1-63(Execute 1-64);128-191 (Storage 1-64)	1 byte	CRWTU

This object is used to execute or store a scenario with a specified scenario number. According to the KNX scenario numbers could be between 1-64. If a scenario wanted to be stored, the scenario number + 128 value must be sent. Also, this object is always visible.

DPT: 18.001 (Scene Control)

146, 148, 150 152, 154	Scene 1...5 Run	0-Nothing;1-Run Scene	1 bit	CWT
---------------------------	-----------------	-----------------------	-------	-----

This object is used to run the associated scenario number 1 to 5. These scenario numbers are listed on the scene parameter page.

DPT: 1.002 (Boolean)

147, 149, 151, 153, 155	Scene 1...5 Storage	0-Nothing;1-Storage Scene	1 bit	CWT
----------------------------	------------------------	---------------------------	-------	-----

This object is used to record the current status of the air conditioner unit to the desired scenario from 1 to 5. The desired scenario number (e.g., 68) can be assigned to these scenes.

DPT: 1.002 (Boolean)

156	Current Scene Feedback	1-64:Current Scene	1 byte	CRT
-----	---------------------------	--------------------	--------	-----

This object is used to view the current scene of the air conditioner unit. Scene values can be monitored from the KNX bus line. According to KNX standards scene values should be between 1-64.

DPT: 17.001 (Scene Number)

## 4.9. Special Group Objects

In this section, special functions group objects and their properties are described.

Object Number	Object Name	Function	Type	Flags
161	Working Hour Counter Feedback	Working Hours Counter Feedback	5 bytes	CRT

This object is used to detect the air conditioner's operating hours in working mode. When the air conditioner starts to work, the working hours counter starts to count the value.

DPT: 13.100 (Time Lag (s))

162	Working Hour Alert Feedback	0-No Alarm;1-Alarm	1 bit	CRT
-----	-----------------------------	--------------------	-------	-----

This object is used to view the air conditioner unit's alert status when the specified working hours operation period ends. Counter creates an alert to warn the user.

DPT: 1.005 (Alarm)

163	Reset Hours Counter	0-No Action;1-Reset	1 bit	CW
-----	---------------------	---------------------	-------	----

This object is used to reset the counted hours by the working hours counter function. If a value 1 is sent via this object, the working hours counter will be reset.

DPT: 1.015 (Reset)

132	Window Contact Status	0-Opened;1-Closed 0-Closed;1-Opened	1 bit	CRWT
-----	-----------------------	--	-------	------

This object is used to receive the status of the window contact. It can be configured which value to which it means from the parameter page.

DPT: 1.009 (Open/Close) / 1.019 (Window/Door)

133	Window Switch-Off Delay	Values are accepted according to the data type of 20.013.	1 byte	CW
-----	-------------------------	---	--------	----

This object is used to switch off the air condition unit according to delay time by a 1-byte value.

DPT: 20.013 (Time Delay)

<b>134, 138</b>	<b>Standby X Function</b>	<b>0-Not Occupied;1-Occupied 0-Stop;1-Start</b>	<b>1 bit</b>	<b>CW</b>
-----------------	---------------------------	---	--------------	-----------

This object is used to control the standby function of the air conditioner unit. The object also can be parameterized as start/stop or occupied/not occupied.

DPT: 1.018 (Occupancy) / 1.010 (Start/Stop)

<b>135, 139</b>	<b>Standby X Feedback</b>	<b>0-Not Occupied;1-Occupied 0-Stop;1-Start</b>	<b>1 bit</b>	<b>CRT</b>
-----------------	---------------------------	---	--------------	------------

This object is used to view the air condition unit's standby function status.

DPT: 1.018 (Occupancy) / 1.010 (Start/Stop)

<b>136, 140</b>	<b>Standby X Delay</b>	<b>Values are accepted according to the data type of 20.013.</b>	<b>1 byte</b>	<b>CW</b>
-----------------	------------------------	--	---------------	-----------

This object is used to set the delay time of the air conditioner unit's standby function.

DPT: 20.013 (Time Delay)

<b>137, 141</b>	<b>Standby X Setpoint Shifting</b>	<b>Temperature (Celsius)</b>	<b>2 bytes</b>	<b>CWT</b>
-----------------	------------------------------------	------------------------------	----------------	------------

This object is used to set the setpoint shifting of the air conditioner unit's standby function.

DPT: 9.001 (Temperature (°C))

<b>142</b>	<b>Timer Function</b>	<b>0-Stop;1:Start 0-Start;1:Stop</b>	<b>1 bit</b>	<b>CW</b>
------------	-----------------------	--	--------------	-----------

This object is used to control the timer function of the air conditioner unit. The start and stop operations can be determined with which value will be used. Value 1 can be start function or stop according to settings. The air conditioner will stop after time is ended.

DPT: 1.010 (start/stop)

<b>143</b>	<b>Feedback Timer Function</b>	<b>0-Stop;1:Start 0-Start;1:Stop</b>	<b>1 bit</b>	<b>CRT</b>
------------	--------------------------------	--	--------------	------------

This object is used to view the timer function status of the air conditioner unit.

DPT: 1.010 (start/stop)

144	Timer Duration	Values are accepted according to the data type of 20.013	1 byte	CW
-----	----------------	--	--------	----

This object is used to specify the time duration of the timer function.

DPT: 20.013 (Time Delay)

---

## Appendix

Error Code Remote Controller Display (ASCII)	Error Code Hex	Error Definition
CH1	1	Room air sensor fault
CH2	2	Indoor unit pipe in sensor fault
CH3	3	Communication fault between the wired remote controller and indoor unit
CH4	4	Drain pump fault
CH5	5	Communication fault between indoor unit and outdoor unit
CH6	6	Indoor unit pipe out sensor fault
CH7	7	Indoor unit mode runs on opposite to outdoor unit
CH8	8	N/A
CH9	9	EEPROM memory fault
CH10	A	BLDC motor signal fault or motor lock
CH11	B	HEX middle point sensor fault
CH12	C	Heater terminal block sensor fault
CH13	D	N/A
CH14	E	N/A
CH15	F	N/A
CH16	10	N/A
CH17	11	Outlet air sensor fault
CH18	12	Return air sensor fault
CH19	13	No communication response from sub-PCB to main PCB
CH20	14	No communication response from main PCB to sub-PCB
CH21	15	IPM fault
CH22	16	AC input is over current (RMS)
CH23	17	DC link low or high voltage
CH24	18	High pressure or low pressure switch on
CH25	19	High/low input voltage
CH26	1A	Compressor start failure
CH27	1B	PSC/PFC fault

CH28	1C	DC link high voltage
CH29	1D	Overcurrent at compressor input
CH32	20	Discharge temperature is high at inverter compressor
CH33	21	Discharge temperature is high at constant speed compressor
CH34	22	High pressure is too high
CH35	23	Low pressure is too low
CH36	24	The compression ratio is too low
CH39	27	Communication fault between PFC and inverter PCB
CH40	28	CT sensor fault
CH41	29	Discharge sensor at inverter compressor is the fault
CH42	2A	The low-pressure sensor is the fault
CH43	2B	The high-pressure sensor is the fault
CH44	2C	Air sensor at outdoor unit is the fault
CH45	2D	HEX sensor at outdoor unit is the fault
CH46	2E	Compressor suction sensor is the fault
CH47	2F	Discharge sensor at constant speed compressor is the fault
CH48	30	HEX outlet sensor at outdoor unit is the fault
CH49	31	IPM temperature sensor is the fault
CH50	32	Missing phase among 3 phase
CH51	33	Over combination ratio
CH52	34	No communication from inverter PCB detected at main PCB
CH53	35	Communication fault between indoor and outdoor unit
CH54	36	The reverse-phase is detected
CH57	39	No communication from main PCB detected at inverter PCB
CH59	3B	Wrong outdoor unit combination
CH60	3C	Inverter EEPROM memory fault
CH61	3D	Outdoor pipe temperature is too high
CH62	3E	IPM temperature is too high
CH65	41	IPM temperature sensor is the fault
CH67	43	Fan locked or fan start failure

CH69	45	CT sensor of constant speed compressor 1 is the fault
CH70	46	CT sensor of constant speed compressor 2 is the fault
CH71	47	PFC CT sensor fault
CH72	48	Function error of outdoor 4way valve. (reversing valve)
CH73	49	DC peak current is over
CH74	4A	Unbalance at 3 phase
CH75	4B	Fan CT sensor fault
CH76	4C	Fan DC link voltage is high
CH77	4D	Fan input voltage is high
CH78	4E	Fan hall sensor fault
CH79	4F	Fan motor start failure
CH86	56	Main PCB EEPROM is fault
CH87	57	Fan PCB EEPROM is fault
CH88	58	PFC PCB EEPROM is fault
CH90	5A	Inlet temperature sensor of external PCB is fault
CH91	5B	The outlet temperature sensor of the external PCB is the fault
CH104	68	No Communication from the slave is detected
CH105	69	Communication fault between fan and inverter PCB
CH106	6A	Fan PCB IOM fault
CH107	6B	Fan DC link voltage is low
CH113	71	Liquid pipe sensor fault
CH114	72	Subcooling inlet pipe sensor fault
CH115	73	Subcooling outlet pipe sensor fault
CH116	74	Oil level sensor fault
CH145	91	No communication from external PCB is detected at the main PCB
CH151	97	4-way valve failure
CH153	99	Upper HEX sensor fault
CH154	9A	Bottom HEX sensor fault
CH173	AD	Over / low current at constant speed compressor 1
CH174	AE	Over / low current at constant speed compressor 2

CH182	B6	Communication fault between main and sub micom in external PCB
CH187	BB	Hydrokit water temperature sensor fault
CH190	BE	Inverter PCB heat sink temperature is high
CH191	BF	Inverter PCB heat sink temperature sensor fault
CH193	C1	Fan PCB heat sink temperature is high
CH194	C2	Fan PCB heat sink temperature sensor fault
CH200	C8	Auto piping failure
CH201	C9	Fault at liquid pipe sensor of HR unit
CH202	CA	Fault at subcooling inlet pipe sensor of HR unit
CH203	CB	Fault at subcooling outlet pipe sensor of HR unit
CH204	CC	No communication from the outdoor unit is detected at the HR unit
CH205	CD	HR unit addresses are duplicated
CH237	ED	No response from the outdoor unit modem at the indoor unit modem
CH238	EE	No response from the outdoor unit at the outdoor unit modem
??	3F3F	Unknown Error
4096	1000	Ac Communication Error
4097	1001	Ac Error Transmit
4098	1002	Ac Error Receive
4101	1005	Ac Error No Ambient Temp

## Special Notes



If you encounter an error code not listed in this table, please contact your nearest LG/Beko/Arcelik technical service.

---

## CONTACT INFORMATION

---

### THE INTERRA WEBSITE

Interra provides documentation support via our web site [www.interratechnology.com](http://www.interratechnology.com). This website is used as a means to make files and information easily available to customers. Accessible by using your favourite Internet browser, the website contains the following information:

- Information about our products and projects.
- Overview of Interra company and values.
- Product Support: Datasheets, product manuals, application descriptions, latest software releases, ETS databases and archived software.

### EUROPE, Turkiye

Interra Technology

Cumhuriyet mah. Kartal cad. Interra R&D Center

No:95/1 Kartal/İstanbul

Tel: +90 (216) 326 26 40 Fax: +90 (216) 324 25 03

Web adress: <http://www.interratechnology.com>