

'INTERRA

—Developer of Uniqueness—

Vaillant VRF Air Condition Units AC - KNX Gateway Product Manual

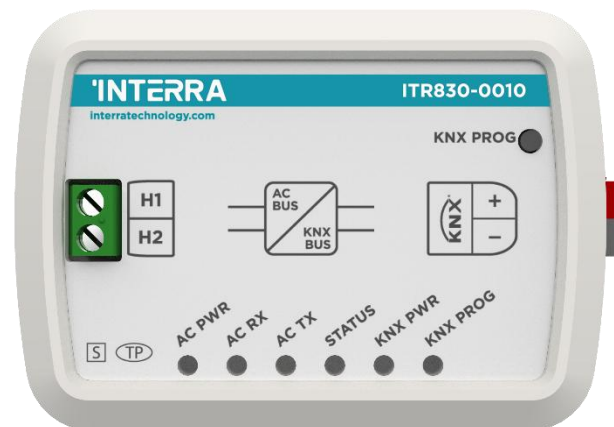

Contents

1. Content of The Document	5
2. Product Description	6
2.1. Technical Information	7
2.2. Model and Variations	8
2.3. Dimensions	8
2.4. Connection Diagram & Features	9
3. ETS Parameters & Descriptions	13
3.1. General Page	14
3.1.1. Parameters List	15
3.2. Logic Gate	18
3.2.1. Parameters List	20
3.3. Converter	22
3.3.1. Parameters List	24
3.4. Operating Mode	27
3.4.1. Parameters List	30
3.5. Fan Speed	32
3.5.1. Parameters List	34
3.6. Temperature	37
3.6.1. Parameters List	39
3.7. Air Deflectors	41
3.7.1. Parameters List	43
3.8. Scenes	44
3.8.1. Parameters List	45
3.9. Special	46
3.9.1. Parameters List	48
3.10. Digital Input	51
3.10.1. Parameters List	52
4. ETS Objects List & Descriptions	54
4.1. General Objects	58
4.2. Logic Gate Objects	60
4.3. Converter Objects	61
4.4. Operating Mode Objects	62
4.5. Fan Group Objects	66
4.6. Temperature Group Objects	70
4.7. Air Deflectors Group Objects	72
4.8. Scene Group Objects	73
4.9. Special Group Objects	74
4.10. Digital Input Objects	77
Appendix	78
Errata	83

Information contained in this publication regarding device applications and the like is provided only for your convenience and may be superseded versions by updates. It is your responsibility to ensure that your application meets your specifications.

INTERRA MAKES NO REPRESENTATIONS OR WARRANTIES OF ANY KIND WHETHER EXPRESS OR IMPLIED, WRITTEN OR ORAL, STATUTORY OR NONSTATUTORY, RELATED TO THE INFORMATION INCLUDING BUT NOT LIMITED TO ITS CONDITION, QUALITY, PERFORMANCE, MERCHANTABILITY OR FITNESS FOR PURPOSE.

Interra disclaims all liability arising from this information and its use. Use of Interra devices in life support and/or safety applications is entirely at the buyer's risk, and the buyer agrees to defend, indemnify and hold harmless Interra from any damages, claims, suits, or expenses resulting from such use. No licenses are conveyed, implicitly or otherwise under any Interra intellectual rights.

Trademarks

The Interra name and logo and the Interra ITR830–X010 Vaillant VRF AC – KNX Gateway devices are registered trademarks of Interra Technology in Turkey and other countries.

All other trademarks mentioned herein are property of the Interra Technology.

©2025, Interra, Printed in Türkiye, All Rights Reserved.



Printed on recycled paper.

TS EN ISO 9001:2008

TO OUR CUSTOMERS

One of our most important aims is to provide you with the best documentation possible to use successfully your Interra products. Focusing on this, we will keep on improving our documentation to better suit your needs. Our publications will be updated as new volumes as soon as changes are introduced.

If you have any questions or comments regarding this publication, do not hesitate to contact us:

E-mail: info@interratechnology.com

Tel: +90 (216) 326 26 40 Fax: +90 (216) 324 25 03

Most Current Product Manual

To obtain the most up-to-date version of this product manual, please visit our website at:

<http://www.interratechnology.com>

You can determine the version of an Interra document by examining its literature number found on the bottom right corner of any page.

The first two letters of the literature are the type of document. The numbers that follow are the creation date of the document and the last letter is the version (e.g., PM181017001A is the version A of a product manual created on the date 17/10/18).

1. Content of The Document

This document contains Interra brandmark's ITR830-X010 Vaillant VRF AC - KNX Gateway coded devices' electronic and all essential feature information for programming these products. Each subtitle explains the characteristics of the device. Modifications of the product and special change requests are only allowed in coordination with product management.

2. Product Description

ITR830-X010 is an air conditioner gateway that is used for monitoring and controlling all the functioning parameters of Vaillant air conditioners via the KNX bus line. Vaillant AC - KNX Gateway is compatible with models in VRF types categorized incompatibility list sold by Vaillant.

Vaillant VRF AC - KNX Gateway has an easy installation feature and can be installed inside the own AC indoor unit or a proper location away from the air conditioner, it connects one side directly to the electronic circuit of the AC indoor unit and in the other side directly to the KNX bus so, Vaillant Gateway provides bidirectional communication between KNX bus and air condition system.

- ITR830-X010 device, provides complete bi-directional integration of Vaillant VRF AC with KNX bus.
- The device provides extra communication objects for giving maximum flexibility.
- Includes 4 logical and 8 converter advanced parameters for energy savings, configurable scenes, temperature limits etc.
- The AC unit provides error notifications for errors that may occur in exceptional cases.
- An ambient temperature value is provided to the Air Conditioner Unit. The temperature value can be acquired from the a KNX object from other KNX devices.
- Up to 5 different modes are available to determine the operating mode such as; auto, heat, cool, fan, and dry.
- Vaillant VRF type AC Indoor unit can be controlled simultaneously by the remote controller of the AC unit and Gateway. (Only available for if only one device connected to the system)
- Vaillant AC indoor unit monitoring from KNX, including monitoring of AC unit's state of internal variables, running working hours counter (E.g., for filter maintenance control), and error indication and error code.
- Control of the AC unit based on the ambient temperature read by the own AC unit, or in the ambient temperature read by any KNX thermostat.
- Special functions for high-level monitoring; window contact, working hours counter, standby and timer function.
- An ambient temperature value is provided to the Air Conditioner Unit. The temperature value can be acquired from the Temperature input of the AC Gateway or, alternatively, through a KNX object from other KNX devices.*
- Via 3 digital inputs, external devices can be connected.*

*: Input 1 - This input can be used for external temperature. If not set parametrically, it can be used as a digital input.

2.1. Technical Information

The following table shows the technical information of the Vaillant VRF AC - KNX Gateway.

Product Code	ITR830-X010
Power Supply	KNX Power Supply
Power Consumption	5 mA
Push Buttons	1 x KNX Programming Button
LED Indicator	1 x KNX Programming LED
Type of Protection	IP 20
Mode of Commissioning	S-Mode
Temperature Range	Operation (-10°C...70°C) Storage (-25°C...100°C)
Maximum Air Humidity	< 90 RH
Colour	Light Grey
Dimensions	88 x 62 x 27 mm (W x H x D)
Configuration	Configuration with ETS

2.2. Model and Variations

ITR830-X ₁ 010	
X ₁	0: No Digital Input 1: Digital Input

Table 1: Vaillant VRF AC – KNX Gateway Model Selection Table

2.3. Dimensions

All values given in the device dimensions are millimetres.

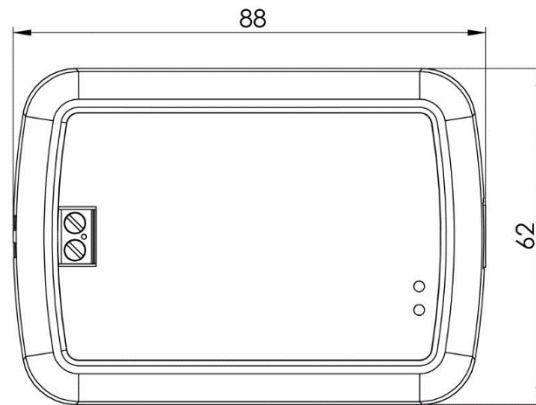

Fig. 1: Dimensions of Vaillant VRF AC - KNX Gateway from the top view

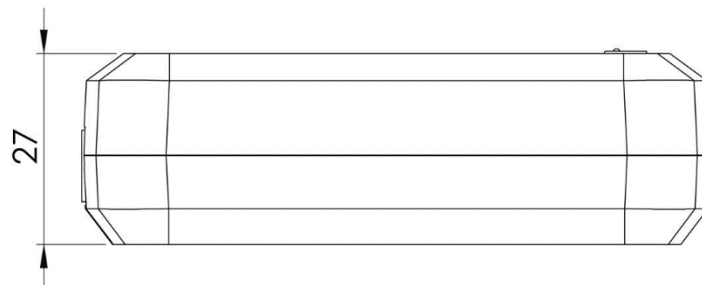

Fig. 2: Dimensions of Vaillant VRF AC - KNX Gateway from the side view

2.4. Connection Diagram & Features

Once the device is provided with a power supply from the KNX bus, both the physical address and the associated application program can be downloaded.

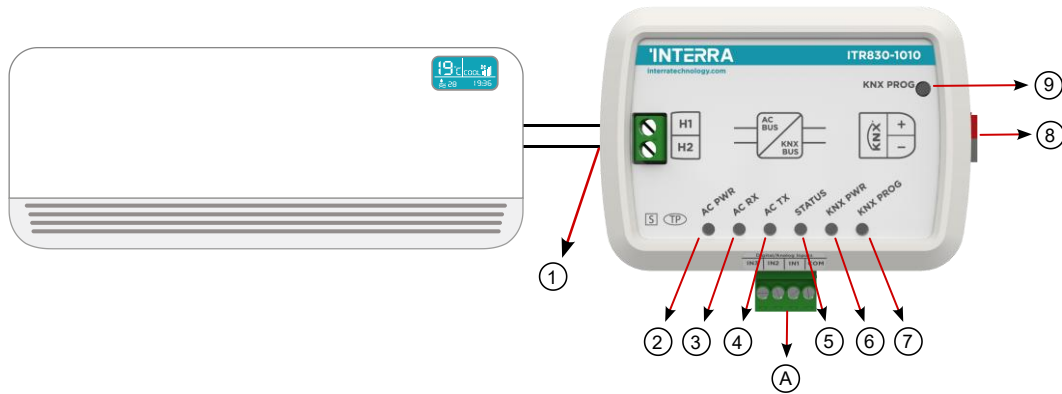

Fig. 3: Diagram of Vaillant VRF AC - KNX Gateway

Number	Feature
1	AC Indoor Unit connection
2	AC Power indicator LED
3	AC Receive Communication LED
4	AC Transmit Communication LED
5	Status LED
6	KNX Power indicator LED
7	KNX Programming LED
8	KNX Connector
9	KNX Programming Button
A	Digital/Analog Input Connector

Table 2: Vaillant VRF AC – KNX Gateway Diagram

Vaillant VRF AC - KNX Gateway can be connected directly to the wired remote communication bus terminal of the AC indoor unit. Nothing that needs to do in ETS software. The following figure shows the Vaillant VRF AC - KNX Gateway connection without the remote controller. At this case the gateway's role must be master.

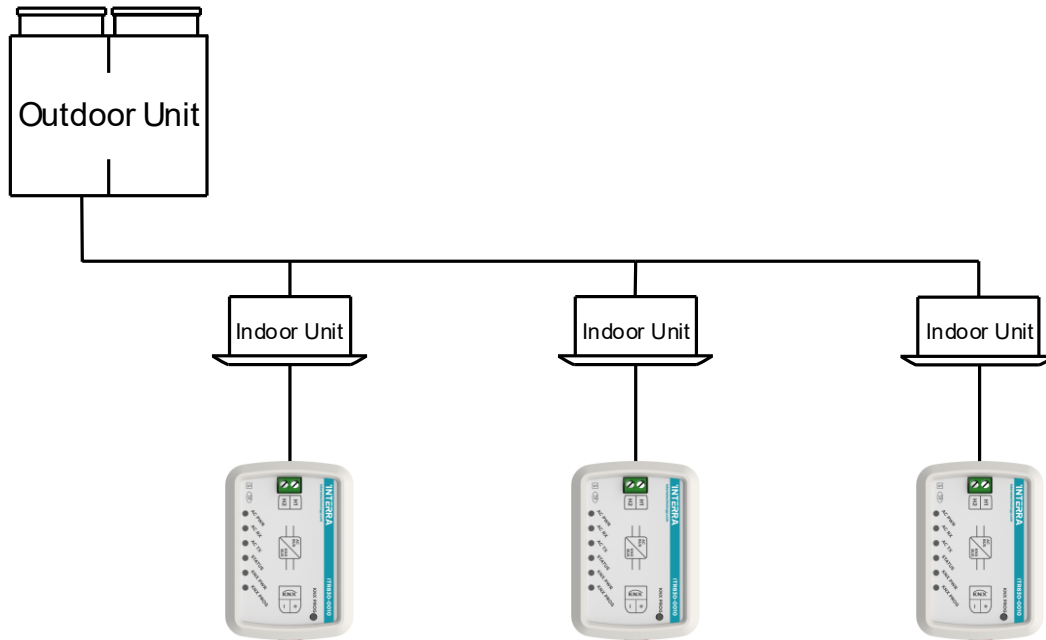

Fig. 4: Vaillant Gateway Connection Diagram without Vaillant Remote Controller

Vaillant VRF AC - KNX Gateway can be connected with Vaillant Wired Remote Controller to the communication bus terminal of the AC indoor unit. In this case, both the gateway and the wired remote control unit can be act as Master or Slave. This role can be selected in the Vaillant VRF Gateway ETS configuration. The following figure shows the Vaillant VRF AC – KNX Gateway connection with the remote controller.

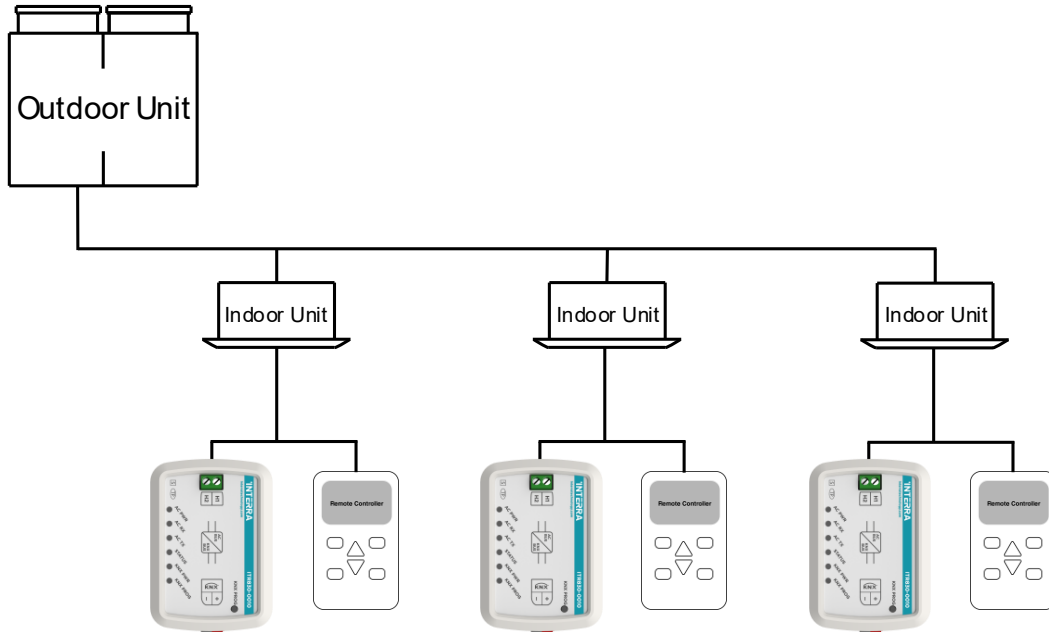

Fig. 5: Vaillant VRF AC – KNX Gateway Connection Diagram with Vaillant Wired Remote Controller

- The wired remote controller is **optional** in this configuration.
- Either one of wired controllers can be set as the master wired controller and the other as the slave wired controller
- If gateway is master, the wired remote must be slave. Check out “[Master and Slave Features](#)”
- If the wired remote is master, gateway must be slave. At this case ambient temperature reference can not selected from “KNX Bus”. Check out “[Master and Slave Features](#)”

Commissioning Instructions



- > First, disconnect the Air Conditioner from mains power.
 - > Then, disconnect the power supply of the AC communication bus.
 - > Install the interface and connect it to the communication bus at any point of the bus. The communication bus is the bus that connects the AC indoor unit and the wired remote controller
 - > Connect the KNX bus to the KNX connector of the interface according to polarity.
 - > Reconnect the AC indoor unit to mains power and power supply to the KNX bus.
 - > Communication Cable polarity is important.
- Please be careful when connecting the indoor unit communication buses of air conditioners.

Master and Slave Mode Features

- Master – Slave function is available only when one indoor unit is selected.

Master Mode	Slave Mod
Ambient temperature can be sent from KNX Bus.	The ambient temperature reference is not selectable. The ambient temperature is sent to the air conditioner from the sensor on the indoor unit or from the wired remote control.
The gateway can works alone in master mode.	The gateway cannot work alone. The one wired remote controller must be connected.

Table 3: Master and Slave Mode Features Table

3. ETS Parameters & Descriptions

In this chapter, the ETS parameters of the Vaillant VRF AC - KNX Gateway device are described using the parameter pages and options. The parameter page features are dynamic structures which means further parameters and parameter pages are enabled depending on the configuration and function of the groups.

In this section, a detailed description of the functional features of the device is given. All the parameters of the device are explained under the relevant headings.

In the ETS parameter configuration pages, each of the parameters has got a default parameter value. These default values are written in bold.

- E.g. : > Setpoint shifting
- **via parameter**
- via communication object

Special Notes



This is a fully compatible KNX device that must be configured and set up using the standard KNX tool ETS.

In the following sections, there is a detailed explanation about each of the different functionalities of Vaillant VRF AC - KNX Gateway in ETS.

3.1. General Page

When the Vaillant VRF AC Gateway is attached to the project from the ETS program, a configuration setting must be made primarily before loading. When entering the “GENERAL” in the parameter page, the configuration screen will be appeared shown below. Global parameter settings for the whole device are made in this window. From the general configuration window, the different advanced functionalities of the Vaillant VRF AC Gateway can be enabled such as Module alive beacon, Behaviours after bus voltage failure, Device control locking, Errors Management, Initial Configuration.

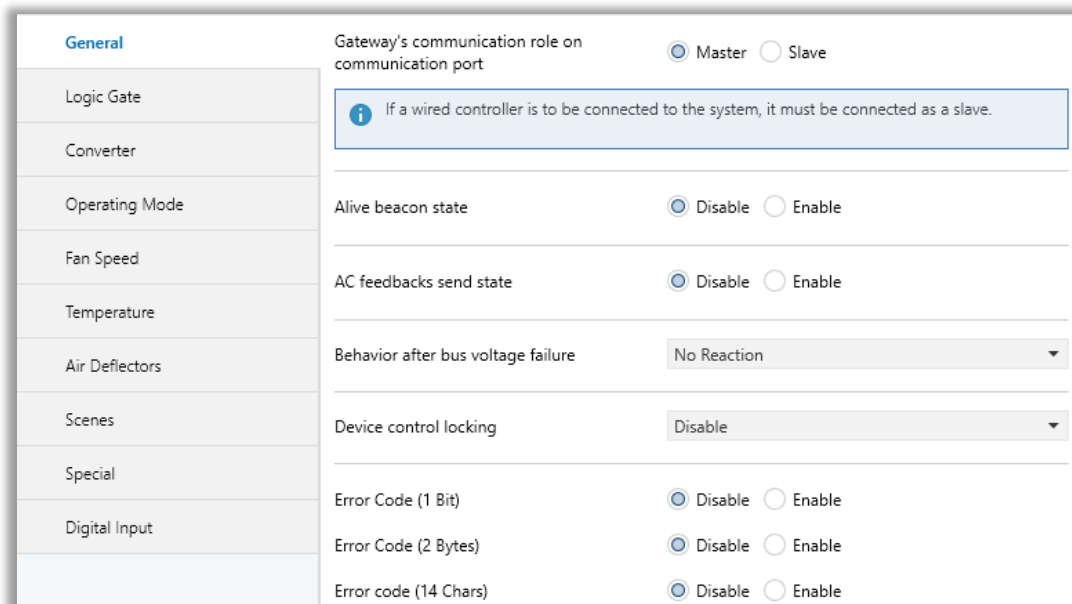

Fig. 6: General Configuration Parameter Page

3.1.1. Parameters List

PARAMETERS	DESCRIPTION	VALUES
Gateway's communication role on communication port	This parameter is used to determine whether the Vaillant VRF AC Gateway and the air conditioner wired remote controller are used together. If the wired remote control is to be used, the controller must be selected as the master. This parameters only available when there is only one air conditioner unit in system.	Master Slave
Alive beacon state	This feature is used to determine whether the Vaillant VRF AC Gateway is operating. With the enabling of the module alive beacon parameter whether the device is working correctly can be known.	Disabled Enabled
> Alive beacon interval ¹	This parameter is used to determine the time of the module alive beacon sending data in minutes.	00:01...00:05... 23:59
> Alive beacon output logic state ¹	The value "0" or "1 is sent with a period determined in "Alive beacon interval" parameter. The receipt of this telegram periodically means that the device is working properly.	Value '0' Value '1'
AC feedbacks send state	This parameter is used to get some status information on the air conditioning unit when the Vaillant VRF AC Gateway is started to operate. This information can be used for these purposes such as: monitoring the air conditioner from a control centre, triggering different scenarios to operate in the KNX infrastructure etc. The following describes which status information can be observed. AC Working Status (On/Off) AC Operating Mode Fan Speed Setpoint Temperature	Disabled Enabled
> AC feedbacks time delay at startup ²	This parameter is used to set the delay between the start-up and the sending of the feedback telegrams to the KNX bus line.	00:05...04:15 mm:ss

<p>> AC feedbacks periodically²</p>	<p>This parameter is used to send feedback on the related objects periodically according to the time in second.</p>	<p>0...255</p>
<p>Behaviour after bus voltage failure</p>	<p>This parameter is used to determine the action that will be taken by the gateway when the KNX bus voltage failure is recovered. If there is a power interruption, one of the following options can be applied.</p> <p>No Reaction:The air conditioner returns the fabrica settings after the power failure.</p> <p>Last State: The air conditioner unit retains its last condition after the power failure.</p> <p>AC ON: The air conditioner will be switched on.</p> <p>AC OFF: The air conditioner will be switched off.</p> <p>Scene: The scene with the desired conditions from 5 different scenes can be sent to the air conditioner unit. In this case, the air conditioner unit operates under these conditions after KNX bus line power failure.</p>	<p>No reaction</p> <p>Last state</p> <p>AC ON</p> <p>AC OFF</p> <p>Scene</p>
<p>> Scene selection³</p>	<p>This parameter is used to determine the appropriate scene from the 5 scenes that can be created. The selected scene conditions are applied to the air conditioner and it works under these conditions after the KNX bus power failure.</p>	<p>Scene 1, Scene 2, Scene 3, Scene 4, Scene 5</p>
<p>Device Control Locking</p>	<p>This parameter is used to lock the Gateway via device control locking communication object. The device is blocked and it can no longer be controlled via any telegram. The device remains in the previous status before locking until the locking is deactivated.</p> <p>Lock on '0': The Gateway will be locked when the value 0 is sent.</p> <p>Lock on '1': The Gateway will be locked when value 1 is sent.</p>	<p>Disabled</p> <p>Lock on '0'</p> <p>Lock on '1'</p>
<p>Error code (1 Bit)</p>	<p>This parameter is used to detect the faults that come from the air conditioner via a 1 bit value.</p>	<p>Disabled</p> <p>Enabled</p>

Error code (2 Bytes)	<p>This parameter is used to detect and identify the faults that come from the air conditioner via a 2-byte value. Each error code has a different meaning so, all of the error code descriptions are listed please check the Appendix section in this document.</p>	Disabled Enabled
Error code (14 Chars)	<p>This parameter is used to detect and identify the faults that come from the air conditioner via a 14 chars value. Each error code has a different meaning so, all of the error code descriptions are listed please check the Appendix section in this document.</p>	Disabled Enabled

¹ This parameter is visible when the function "Alive beacon state" is set to "Enable".

² This parameter is visible when the function "AC feedbacks send state" is set to "Enable".

³ This parameter is visible when the function "Behaviour after bus voltage failure" is set to "Scene".

3.2. Logic Gate

This parameter page is used to make the logical relationships between inputs & output.

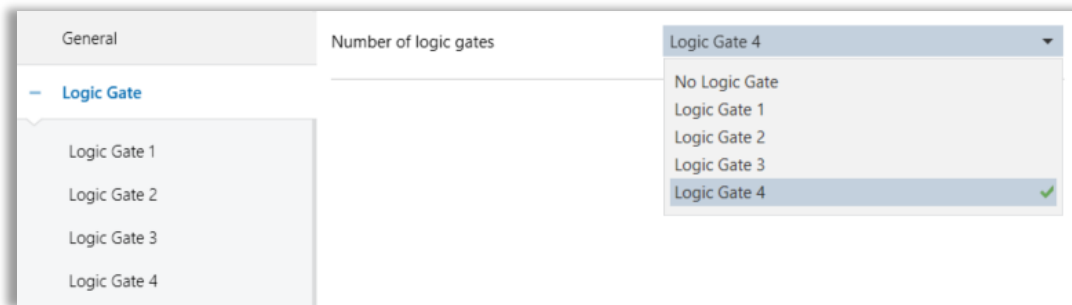

Fig. 7: Logic Gate Configuration Parameter Page

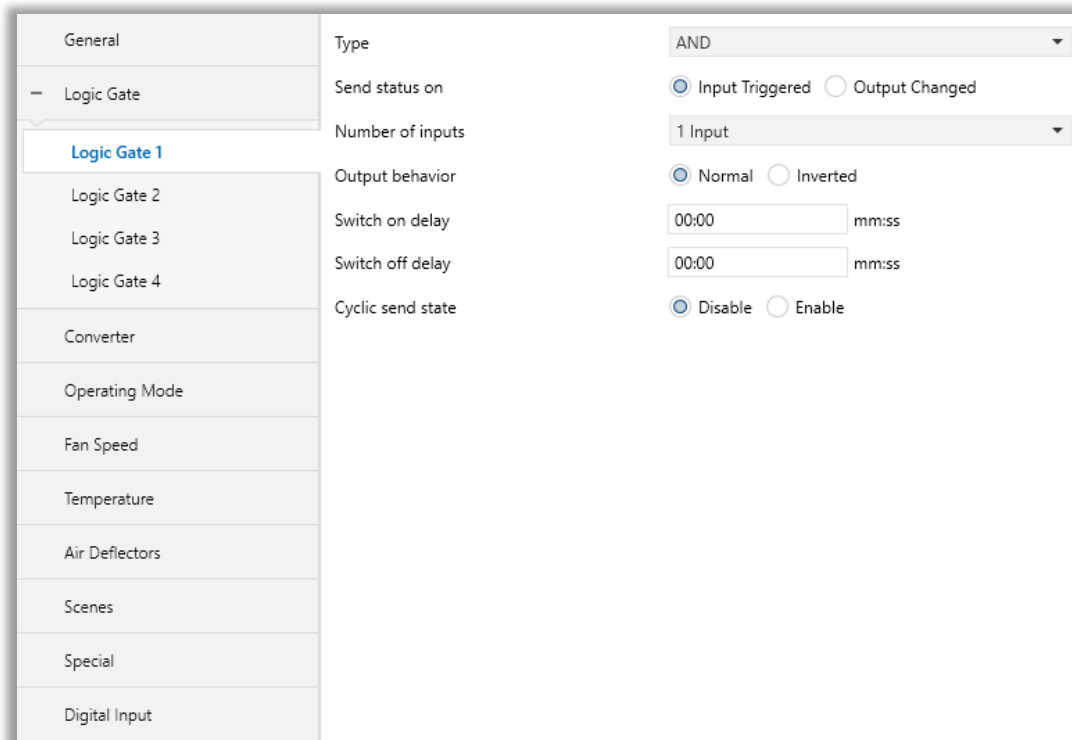

Fig. 8: Logic Gate X Configuration Parameter Page

Up to 4 logic gates can be used with the gateway. In addition, each logic gate allows the use of up to 4 inputs. The standard logic operations AND, OR and XOR are available.

The status of the output of logic gates can be shown normally or inverted. This configuration can be applied via the parameter “Output behaviour” and when it is parameterized as inverted, the status of the output is shown inverted.

Through the parameter “Send status on”, the type of feedback can be defined. The gateway allows sending the result of logic gates when the conversely logic output is changed or when one of the logic inputs is modified. Additionally, it is possible to define a cyclic sending of the feedback which permits getting information about the output status periodically.

The logic output can operate with previously configured delays. The logic output takes the values ON and OFF with delays. Depending on the switch delay parameters configuration, it is possible to set an ON delay (TON), and an OFF delay (TOFF) or both at the same time.

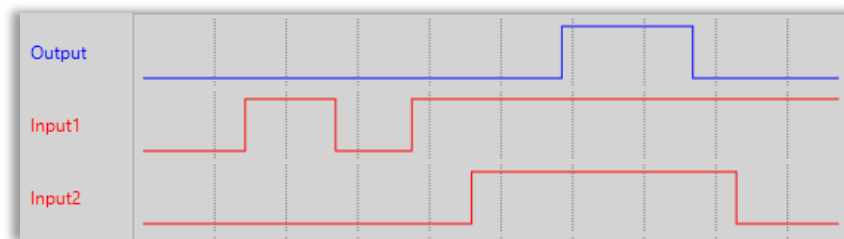

Fig. 9: Logic Gate with Delays

Special Notes



The number of logical gates can be selected up to 4. Since the characteristics of each gate are the same, only Logic 1 is described.

3.2.1. Parameters List

PARAMETERS	DESCRIPTION	VALUES
Number of logic gates	This parameter is used to specify the number of logic gates that are used to write logical functions. Up to 4 different logic gates can be used simultaneously.	No logic gate Logic Gate 1 Logic Gate 2 Logic Gate 3 Logic Gate 4
LOGIC GATE X		
Type	This parameter is used to specify the type of logical gate to be used. There are 3 different logic gate types, AND, OR and XOR. Each logical gate generates a false or true value at its output as a logical association result.	AND OR XOR
Send status on	This parameter is used to specify how the status of the output will be sent. Input Triggered: Output status will be sent when any logic input is received. Output Chaged Output status will be sent when the logic output is changed.	Input Triggered Output Chaged
Number of inputs	This parameter is used to specify the number of inputs for the logical gate.	1 input 2 inputs 3 inputs 4 inputs
Output behaviour	This parameter defines the behaviour of the logic output. Normal: The status of the output is sent without any modification. Inverted: If the value is true, the false value will be sent as a status value for the output or vice versa.	Normal Inverted
Switch on delay	This parameter is used to set a delay time for output behaviour. The output communication object takes the value TRUE when time reaches the configured time in this parameter.	00:00...04:15 mm:ss
Switch off delay	This parameter is used to set a delay time for output behaviour. The output takes the value	00:00...04:15 mm:ss

	FALSE when time reaches the configured time in this parameter.	
Cyclic send state	This parameter is used to send feedback on the related objects periodically according to the determined time in "Send feedback periodically" parameter.	Disabled Enable
>Send feedback periodically¹	This parameter determines the LogicX output communication object sending period in minutes.	00:01...04:15 hh:mm

¹ This parameter is visible when the function "Cyclic send state" is set to "Enable".

Special Notes



The number of logical gates can be selected up to 4. Since the characteristics of each gate are the same, only one is described.

3.3. Converter

The main parameter settings of the Converter Parameter page are made on this page. Various control options for the Converters are enabled from this page.

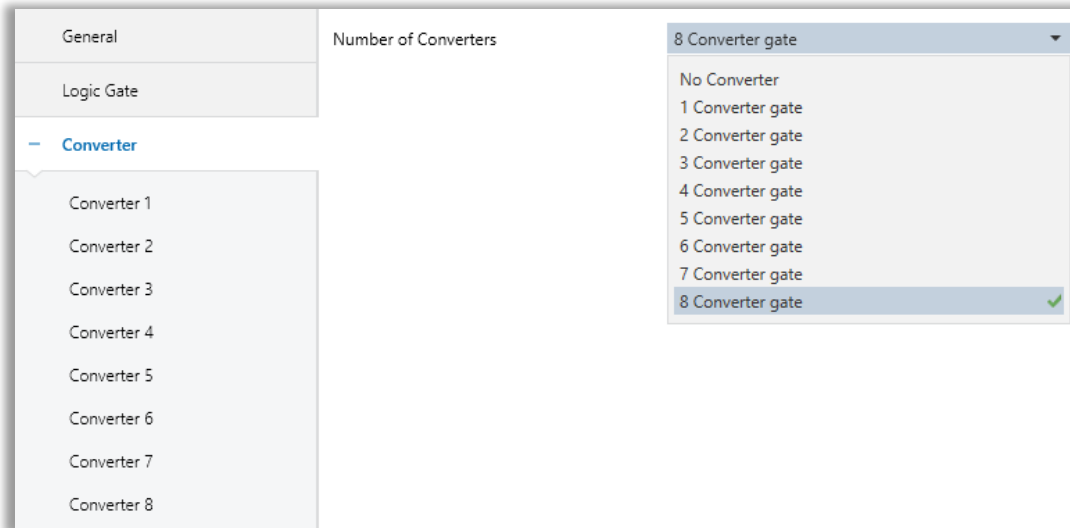

Fig. 10: Converter Configuration Parameter Page

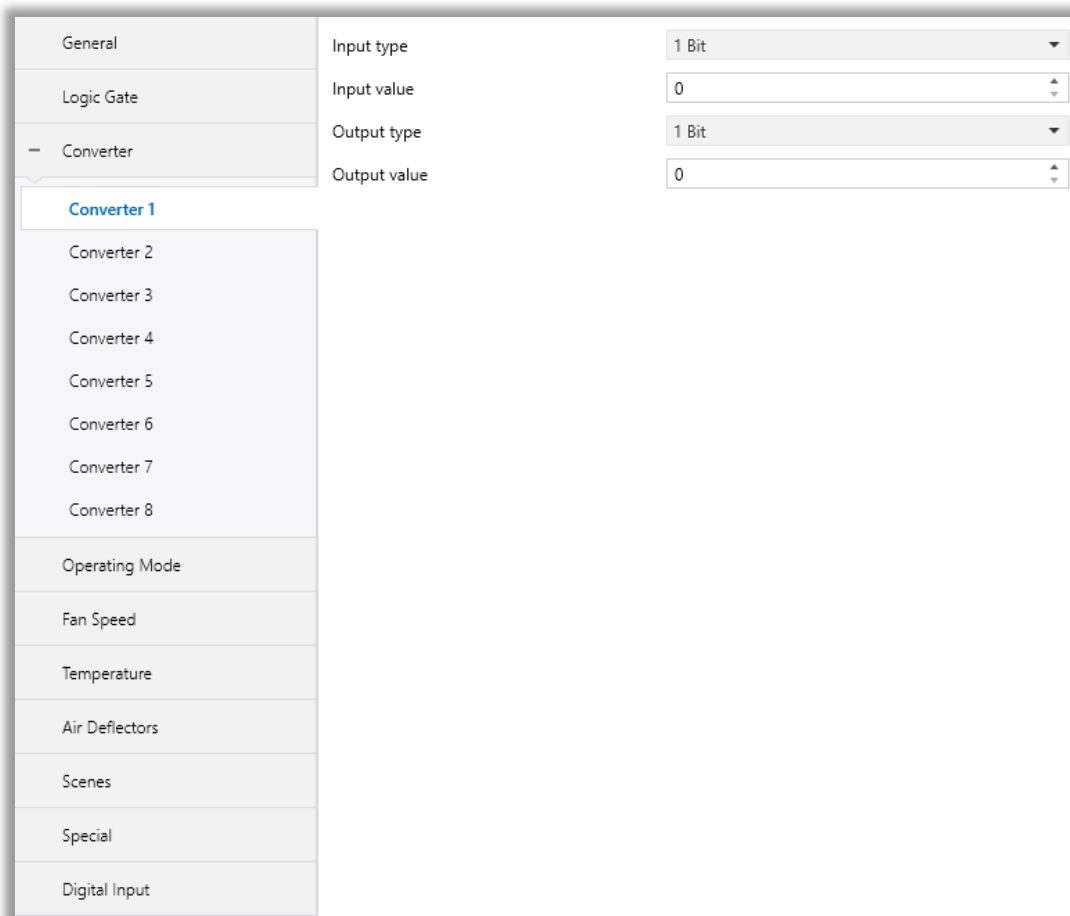

Fig. 11: Converter X Configuration Parameter Page

Converters are used to convert the output to configured type value depending on the input value. There are 8 different types of data input that can be converted to 4 different data values.

Moreover, if the input is selected as 1 byte or 2 bytes, you can also make the four arithmetical operations (plus, minus, multiply, divide). Some examples are shown below :

<p><i>Ex 1:</i></p> <p>Input type: 1 byte, 154</p> <p>Calculation: Plus</p> <p>Calculation value: 7</p> <p>Output type: 1 byte</p> <p>Output = $154 + 7$</p> <p>Output = 161</p>	<p><i>Ex 2:</i></p> <p>Input type: 1 byte, 215</p> <p>Calculation: Minus</p> <p>Calculation value: 51</p> <p>Output type: 1 byte</p> <p>Output = $215 - 51$</p> <p>Output = 164</p>
<p><i>Ex 3:</i></p> <p>Input type: 2 bytes, 862</p> <p>Calculation: Multiply</p> <p>Calculation value: 49</p> <p>Output type: 2 bytes</p> <p>Output = 862×49</p> <p>Output = 42238</p>	<p><i>Ex 4:</i></p> <p>Input type: 2 bytes, 46342</p> <p>Calculation: Divide</p> <p>Calculation value: 986</p> <p>Output type: 2 bytes</p> <p>Output = $46342 : 986$</p> <p>Output = 47</p>

Special Notes



The number of Converters can be selected up to 8. Since the characteristics of each gate are the same, only one is described.

3.3.1. Parameters List

PARAMETERS	DESCRIPTIONS	VALUES
Number of Converters	This parameter is used to determine the number of converter gates. Each converter gate can be set independently.	No converter 1 Converter gate 2 Converter gate 3 Converter gate 4 Converter gate 5 Converter gate 6 Converter gate 7 Converter gate 8 Converter gate
CONVERTER X		
Input type	<p>This parameter is used to specify the type of input value for the converter input. There are 8 different input values for each converter.</p> <p>When the input type is configured as 1-byte or 2- byte logic, the output data type is set as 1 bit. If the input value is non-zero, the output value will be 1. Otherwise, it will be zero.</p>	1 Bit 2 Bits 1 Byte 2 Bytes 1 Byte Logic 2 Bytes Logic 1 Byte Threshold 2 Bytes Threshold
> Input value¹	<p>This parameter is used to set the value of the converter input. Several value types can be selected and these possible values are described below.</p> <p>The input type is 1 Bit: If the input type is selected as 1 bit, values are between 0-1.</p> <p>The input type is 2 Bits: If the input type is selected as 2 bits, values are between 0-3.</p> <p>The input type is 1 Byte: If the input type is selected as 1 byte, values are between 0-255.</p> <p>The input type is 2 Bytes: If the input type is selected as 2 bytes, values are between 0-65535.</p>	0...1 0...3 0...255 0...65535

	<p>The input type is 1 Byte logic : If the input type is selected as 1-byte logic, values are between 0-255.</p> <p>The input type is 2 Bytes logic : If the input type is selected as 2-byte logic, values are between 0-65535.</p> <p>The input type is 1 Byte Threshold : If the input type is selected as a 1-byte threshold, values are between 0-255.</p> <p>The input type is 2 Byte Threshold : If the input type is selected as the 2-byte threshold, values are between 0-65535.</p>	
> Logical Operators ²	<p>This parameter is used to perform a mathematical operation with the input value.</p> <p>Disabled: The calculation value is disabled. The input value is converted to output value without a mathematical operation.</p> <p>Plus: The calculation value is summed with the input value and the result is applied to the output value.</p> <p>Minus: The calculation value is subtracted from the input value and the result is applied to the output value.</p> <p>Multiply: Input value and calculation value are multiplied and the result is applied to the output value.</p> <p>Divide: The input value is divided by the calculation value and the result is applied to the output value.</p>	<p>Disabled</p> <p>Plus</p> <p>Minus</p> <p>Multiply</p> <p>Divide</p>
Calculation Value ³	<p>This parameter is used to specify the value to be processed along with the input value. This value type is the same as the output value type.</p>	<p>0...255</p> <p>0...65535</p>
Lower Limit ⁴	<p>This parameter is used to set the lower limit value of the threshold for the input when the input is configured as 1 byte or 2-byte threshold.</p>	<p>0...255</p> <p>0...65535</p>

	<p>⚠ Lower limit value can not be higher than Upper limit value.</p>	
Higher Limit⁴	<p>This parameter is used to set the higher limit value of the threshold for the input when the input is configured as 1 byte or 2-byte threshold.</p> <p>⚠ Upper limit value can not be lower than Lower limit value.</p>	<p>0...255 0...65535</p>
Output type¹	<p>This parameter is used to specify the type of output value for the converter output. There are 4 different output values for each converter.</p>	<p>1 Bit 2 Bit 1 Byte 2 Byte</p>
Output value¹	<p>This parameter is used to set the value of the converter output. Several value types can be selected and these possible values are described below.</p> <p>The output type is 1 Bit: If the input type is selected as 1 bit, values are between 0-1.</p> <p>The output type is 2 Bit: If the input type is selected as 2 bits, values are between 0-3.</p> <p>The output type is 1 Byte: If the input type is selected as 1 byte, values are between 0-255.</p> <p>The output type is 2 Byte: If the input type is selected as 2 bytes, values are between 0-65535.</p>	<p>0...1 0...3 0...255 0...65535</p>

¹ This parameter is visible when the function "Input type" is set to "1 Bit" or "2 Bits" or "1 Byte" or "2 Bytes".

² This parameter is visible when the function "Input type" is set to "1 Byte" or "2 Bytes".

³ This parameter is visible when the function "Logical Operators" is set to "Plus" or "Minus" or "Multiply" or "Divide". If

⁴ This parameter is visible when the function "Input type" is set to "1 Byte Threshold" or "2 Byte Threshold".

3.4. Operating Mode

In this section, all of the parameters are corresponding to different mode properties and communication objects. Some parameters of related objects and their tasks are described below.

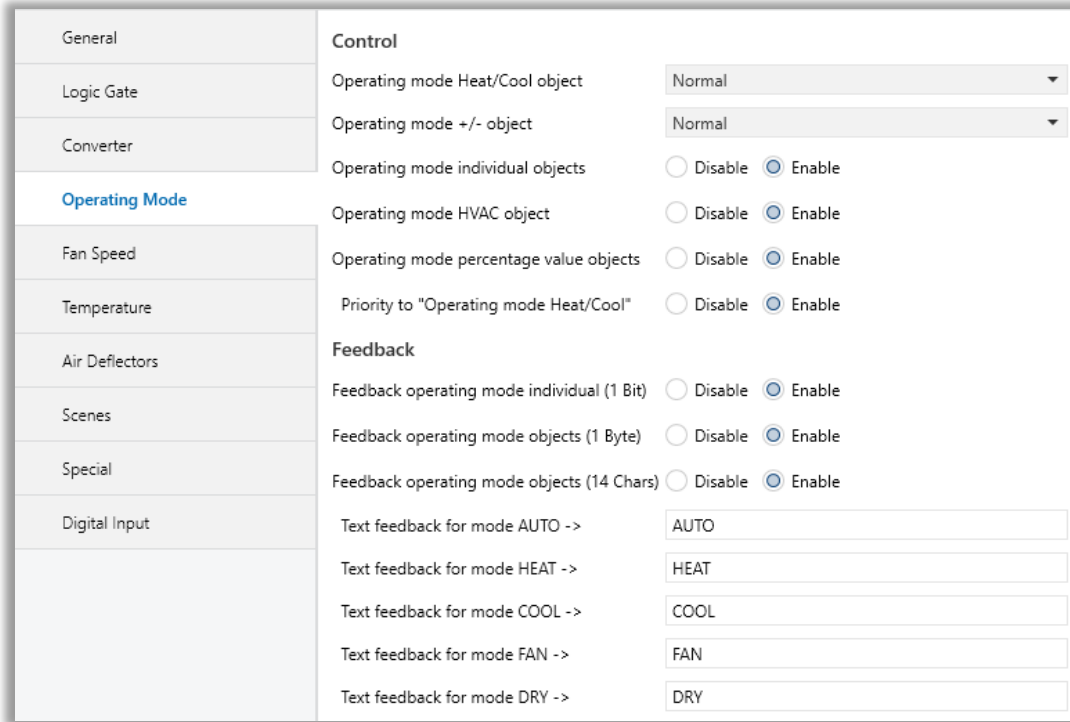

Fig. 12: Operating Mode Parameter Page

Important Notes



- Turbo fan speed can not be activated in mode FAN.
- In the "Dry" modes, the fan speed is set to "1" and will not change.
- Mode can be Heat or Cool in mode Auto. The airconditioning decides it.

- **Operating Mode:** The operating mode can be modified with these values that are shown in the table below:

OPERATING MODE	VALUE
AUTO	0
HEAT	1
COOL	3
FAN	9
DRY	14

Table 4: Operating Mode List

- **Operating Mode Cool/Heat:** The operating mode of the air conditioner can be selected as the heating mode or cooling mode with this 1-bit object.

- **Mode Individual objects (1-bit):** The operating mode can be modified by sending value 1 to the desired mode object.
- **Mode +/- object (1 bit) :** Using this object 4 different operating modes can be selected. The selection can be made with 1-bit values. Switching between the modes is done according to the following condition :

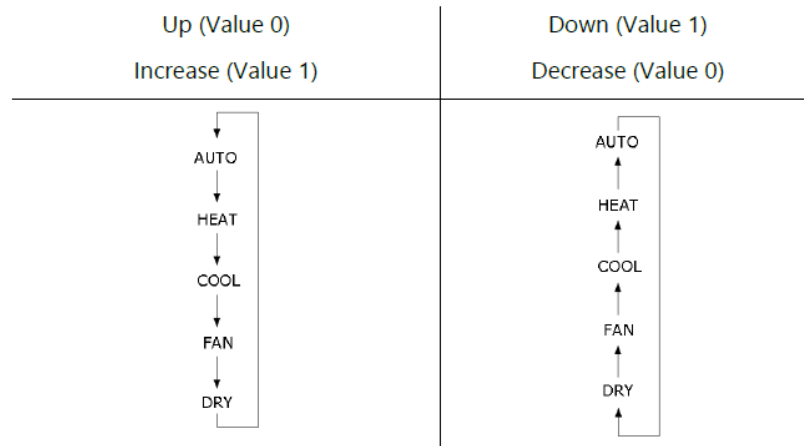

- **Mode Percent Value Objects (Mode Heating_Percentage - Mode Cooling_Percentage):** Via these 1-byte objects the indoor unit can be controlled via percentage values to provide compatibility with the thermostat that uses this data type. By using this object, there are two different options:
 - Priority to "Operating mode Heat/Cool" : Disabled
When the priority of "Operating mode Heat/Cool" is disabled, it does not matter what is the current mode of the indoor unit, the percentage values can switch the mode and activate the indoor unit in the following way:
 - If the object "Mode Heating_Percentage" takes a value greater than 0, the indoor unit will be switched ON in HEAT mode. The value 0 will switch off the air conditioner.
 - If the object "Mode Cooling_Percentage" takes a value greater than 0, the indoor unit will be switched ON in COOL mode. The value 0 will switch off the air conditioner.

Special Notes



- When the priority is disabled and the air condition unit is working as FAN or DRY modes, a new value to the objects "Mode Heating_Percentage - Mode Cooling_Percentage" or "Operating Mode Cool/Heat" will change the mode to HEAT or COOL.
- In Auto mode, the air conditioner sets the operating mode (heat or cool) and operates in that mode.

- Priority to "Operating mode Heat/Cool" : Enabled
When the priority is enabled, the operating mode defined cannot be modified by the percentage value objects and the behaviour will be as follow:
 - Actual operating mode as HEAT;
 - If the object "Mode Heating_Percentage" takes a value greater than 0, the indoor unit will be switched ON. The value 0 will switch off the air conditioner.
 - Any data received via the object "Mode Cooling_Percentage" will not be taken into consideration.
Actual operating mode as COOL;

- If the object “**Mode Cooling_Percentage**” takes a value greater than 0, the indoor unit will be switched ON. The value 0 will switch off the air conditioner.
- Any data received via the object “**Mode Heating_Percentage**” will not be taken into consideration.

Special Notes



When the priority is enabled and the air condition unit is working as FAN or DRY modes, a new value to the objects “**Mode Heating_Percentage - Mode Cooling_Percentage**” will not be taken into consideration. Only a new value to the object “**Operating Mode Cool/Heat**” will change the mode to HEAT or COOL.

Special Notes



Any modification on all above objects will be advised in the following feedback objects:

- Mode Cool/Heat Feedback
- Mode Auto Feedback
- Mode Heat Feedback
- Mode Cool Feedback
- Mode Fan Feedback
- Mode Dry Feedback
- Operating Mode Feedback
- Operating Mode Text Feedback

3.4.1. Parameters List

PARAMETERS	DESCRIPTION	VALUES
Operating mode Heat/Cool object	<p>This parameter is used to enable or disable the operating mode heat/cool and its feedback objects.</p> <p>Normal: If value 1 is sent via a related object, the air conditioner switches to heat mode.</p> <p>Inverted: If value 1 is sent via a related object, the air conditioner switches to cool mode.</p>	<p>Disabled</p> <p>Normal</p> <p>Inverted</p>
Operating mode +/- object	<p>This parameter is used to enable or disable the operating mode +/- object.</p> <p>Normal(1:Increase/0:Decrease): If the value 1 is sent, the modes switch according to the following sequence Auto->Heat->Cool->Fan->Dry</p> <p>Inverted(0:Up/1:Down): If the value 0 is sent, the modes switch according to the following sequence Auto->Heat->Cool->Fan->Dry</p>	<p>Disabled</p> <p>Normal</p> <p>Inverted</p>
Operating mode individual objects	<p>This parameter is used to enable the operating modes individual objects. These objects are :</p> <ul style="list-style-type: none"> ->Mode Auto ->Mode Heat ->Mode Cool ->Mode Fan ->Mode Dry 	<p>Disabled</p> <p>Enabled</p>
Operating mode HVAC object	<p>This parameter is used to enable or disable operating mode objects. Via this object, if the specified values are sent to the corresponding mode the operating mode is switched to that mode.</p>	<p>Disabled</p> <p>Enabled</p>
Operating mode percentage value objects	<p>This parameter is used to enable the percent value objects of heating mode and cooling mode.</p>	<p>Disabled</p> <p>Enabled</p>
> Priority to "Operating mode Heat/Cool"¹	<p>This parameter is used to enable or disable the giving priority to operating mode Heat/Cool.</p>	<p>Disabled</p> <p>Enabled</p>

Feedback operating mode individual objects (1 Bit)	This parameter is used to enable or disable the feedback objects of individual operating mode objects. If this parameter is enabled, all of the individual feedback objects of operating modes are visible.	Disabled Enabled
Feedback operating mode objects (1 Byte)	This parameter is used to enable or disable the 1 Byte feedback object of the operating mode. According to special values, the operating mode can be easily detected.	Disabled Enabled
Feedback operating mode text object (14 Chars)	This parameter is used to enable or disable the feedback operating text mode objects.	Disabled Enabled
-> Text feedback for mode AUTO²	This parameter is used to type a special name for the operating mode AUTO feedback text object.	-
-> Text feedback for mode HEAT²	This parameter is used to type a special name for the operating mode HEAT feedback text object.	-
-> Text feedback for mode COOL²	This parameter is used to type a special name for the operating mode COOL feedback text object.	-
-> Text feedback for mode FAN²	This parameter is used to type a special name for the operating mode FAN feedback text object.	-
-> Text feedback for mode DRY²	This parameter is used to type a special name for the operating mode DRY feedback text object.	-

¹ This parameter is only visible when the parameter "Operating mode percentage value objects" is set to "Enabled".

² This parameter is only visible when the parameter "Feedback operating mode text object (14 Chars)" is set to "Enabled".

3.5. Fan Speed

Fig. 13: Fan Speed Configuration Parameter Page

Important Notes



- In the "DRY" modes, the fan speed is set to "Fan Speed 1" and will not change.
- Turbo fan speed can not be activated in mode FAN.
- Maximum level of fan speed depends the model of air conditioner unit. Please refer the user manual of air conditioner manual.

Fan Speed Enumerated/Scaling: The fan speed can be driven by "numbered or scaled object," selectable by the parameter "Fan level control & feedback objects (1 byte)".

Fan speed Enumerated object can control fan speed of air conditioner via 1 byte object.

FAN SPEED	VALUE
FAN AUTO	0
FAN 1	1
FAN 2	2
FAN 3	3
FAN 4	4
FAN 5	5
FAN TURBO	6

Table 5: Fan Speed - Enumerated Value Table

Fan Speed Scaling object can control the fan speed of the air conditioner according to the value range of predefined parameters.

Example:

If "Fan Speed Scaling" communication object value has given 18%, fan level set to Fan speed 1

Fan level control & feedback objects (1 Byte) Scaling	
Fan speed 1 lower limit (%)	0
Fan speed 2 lower limit (%)	20

Fig. 14: Fan Speed Scaling Configuration

- **Fan Speed Individual objects (1-bit):** The fan speed of the air conditioner can be selected as the speed auto to 7 with this 1-bit object. When the "Fan Speed Auto Control" object is deactivated, fan speed returns to the previous position before activated that object.
- **Fan Speed +/- object:** Using this object 8 different fan speeds can be selected. The selection can be made with 1-bit values. Switching between the fan speed depends to selected parameters.

*If the "Loop the sequence" parameter is enabled, the loop changes according to the state of the "Include AUTO fan mode in the sequence" parameter. If the " Include AUTO fan mode in the sequence " parameter is enabled, the increment after Fan speed 5 sets the fan speed level to AUTO. Subsequent increments continue arithmetically.

Special Notes



If a value greater than 6 is received, this data will be accepted and the fan will set at the maximum speed.

Special Notes



Any modification on all above objects will be advised in the following feedback objects:
 Fan Speed Enumerated Feedback
 Fan Speed Auto Feedback
 Fan Speed X Feedback,
 Fan Speed Text Feedback
 *X: 1/2/3/4/5/Turbo

3.5.1. Parameters List

PARAMETERS	DESCRIPTION	VALUES
Fan level control +/- object	<p>This parameter is used to enable or disable the fan level control +/- object.</p> <p>Normal (1:Increase/0:Decrease): If the value 1 is sent, the fan levels switch according to the following sequence Auto->Fan Level 1-> ... -> Fan Level Turbo</p> <p>Inverted (0:Up/1:Down): If the value 1 is sent, the fan levels switch according to the following sequence Fan Level Turbo-> ... ->Fan Level 1->Auto</p>	<p>Disabled</p> <p>Normal</p> <p>Inverted</p>
> Include AUTO fan mode in the sequence ¹	This parameter is used to add AUTO fan mode to fan levels.	<p>No</p> <p>Yes</p>
> Loop the sequence ¹	This parameter is used to enable or disable the fan level sequence repeating considering the selected parameter polarity.	<p>No</p> <p>Yes</p>
Fan level control individual objects	<p>This parameter is used to enable or disable the fan level control individual objects. For each fan speed level, there is an individual fan speed object. These objects are:</p> <p>Fan Speed 1 Control</p> <p>Fan Speed 2 Control</p> <p>Fan Speed 3 Control</p> <p>Fan Speed 4 Control</p> <p>Fan Speed 5 Control</p> <p>Fan Speed Turbo Control</p> <p>Fan Speed Auto Control</p>	<p>Disabled</p> <p>Enabled</p>
Fan level control & feedback objects (1 Byte)	<p>This parameter is used to determine the fan level control type with 1-byte communication objects</p> <p>Scaling: Via scaling object, according to the threshold defined in parameters fan speed will be determined.</p> <p>Enumerated: Via enumerated object, if value 0 is sent fan level will be fan speed auto. Likewise, value 2 causes fan speed 2 and value 3 causes fan speed 3 etc.</p>	<p>Disabled</p> <p>Scaling</p> <p>Enumerated</p>

> Fan speed 1 lower limit (%) ²	This parameter is used to set the lower limit 1 fan level threshold value to compare with the received value from the KNX bus line. After comparison, the corresponding fan speed will be chosen.	0...100
> Fan speed 2 lower limit (%) ²	This parameter is used to set the lower limit 2 fan level threshold value to compare with the received value from the KNX bus line. After comparison, the corresponding fan speed will be chosen.	0...100
> Fan speed 3 lower limit (%) ²	This parameter is used to set the lower limit 3 fan level threshold value to compare with the received value from the KNX bus line. After comparison, the corresponding fan speed will be chosen.	0...100
> Fan speed 4 lower limit (%) ²	This parameter is used to set the lower limit 4 fan level threshold value to compare with the received value from the KNX bus line. After comparison, the corresponding fan speed will be chosen.	0...100
> Fan speed 5 lower limit (%) ²	This parameter is used to set the lower limit 5 fan level threshold value to compare with the received value from the KNX bus line. After comparison, the corresponding fan speed will be chosen.	0...100
> Fan speed Turbo lower limit (%) ²	This parameter is used to set the lower limit Turbo fan level threshold value to compare with the received value from the KNX bus line. After comparison, the corresponding fan speed will be chosen.	0...100
Feedback fan speed level individual (1 Bit)	This parameter is used to enable or disable the individual fan level object feedbacks.	Disabled Enabled
Feedback fan speed text object (14 chars)	This parameter is used to enable or disable the feedback fan level text object.	Disabled Enabled
-> Text feedback for mode Fan Auto ³	This parameter is used to type a special name for Auto mode text feedback.	-
-> Text feedback for mode Fan Speed 1 ³	This parameter is used to type a special name for fan speed 1 text feedback.	-
-> Text feedback for mode Fan Speed 2 ³	This parameter is used to type a special name for fan speed 2 text feedback.	-
-> Text feedback for mode Fan Speed 3 ³	This parameter is used to type a special name for fan speed 3 text feedback.	-
-> Text feedback for mode Fan Speed 4 ³	This parameter is used to type a special name for fan speed 4 text feedback.	-

<p>-> Text feedback for mode Fan Speed 5³</p>	<p>This parameter is used to type a special name for fan speed 5 text feedback.</p>	<p>-</p>
<p>-> Text feedback for mode Fan Speed Turbo³</p>	<p>This parameter is used to type a special name for fan speed Turbo text feedback.</p>	<p>-</p>

¹ This parameter is only visible when the parameter "Fan level control +/- object" is set to "Normal" or "Inverted".

² This parameter is only visible when the parameter "Fan level control & feedback objects (1 Byte)" is set to "Scaling".

³ This parameter is only visible when the parameter "Feedback fan speed text object (14 Chars)" is set to "Enabled".

3.6. Temperature

In this section, all of the parameters are corresponding to the setpoint temperature and ambient temperature. Some parameters of related objects and their tasks are described in this part.

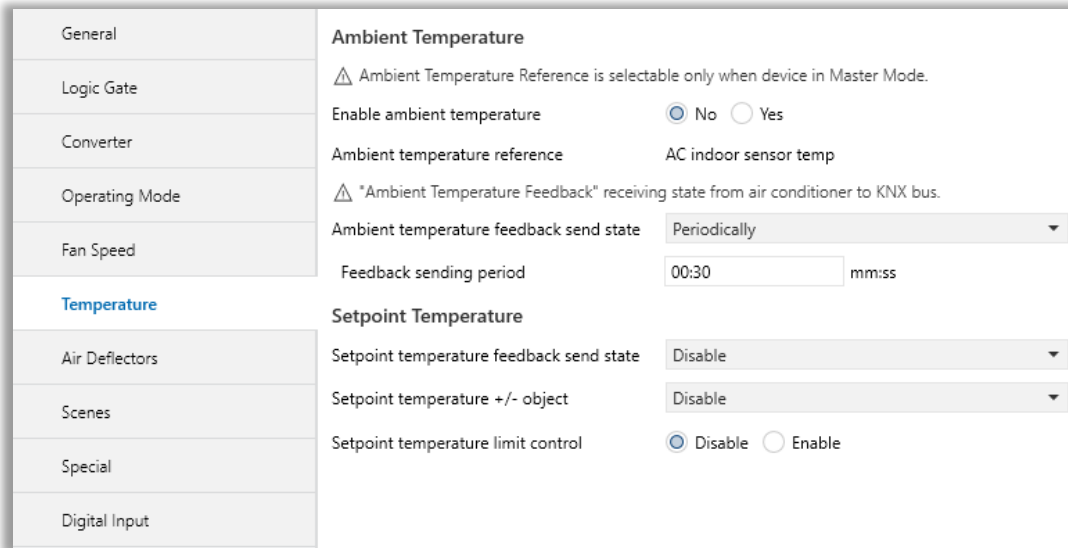

Fig. 15: Temperature Configuration Parameter Page

Ambient Temperature:

The air conditioner indoor unit can display the temperature information via the "Ambient Temperature Feedback" object when "Enable ambient temperature" parameter has selected as "No". However, it is also possible to receive the measurement of the measured ambient temperature from KNX by enabling the parameter "Ambient temperature reference" as KNX bus.

Enable ambient temperature:

When this parameter has not enabled, air conditioner read ambient temperature from indoor unit sensor and sends sensor value to KNX bus according to state of "Ambient temperature feedback send state" parameter.

When the parameter has enabled, temperature reference can selected as "KNX bus".

"KNX bus" selection allow to send room temperature to air conditioner over KNX bus.

Special Note



- If Gateway's communication role on communication port is selected as Slave in General Page, "Ambient temperature reference" can not select "KNX bus". The External NTC cannot be selected. At this case air conditioner can take ambient reference from indoor unit or wired remote controller.
- If "Ambient Temperature Reference" is selected as the external temperature sensor and an NTC is not installed hardware-wise, an error code 0x1004 will be issued.

Special Note



When the “Enable ambient temperature” parameter has enabled if there is no ambient temperature coming from KNX bus through 5 mins, the device select ambient temperature reference as “AC indoor sensor temp” until ambient temperature value sends over KNX again. Temperature value readed from indoor unit can be observed in KNX bus.

Setpoint Temperature:

“Setpoint Temperature Control” object is always enable. Feedback of this object can be disabled or enabled via “Setpoint temperature feedback send state” parameter. The temperature sended to air conditioner can be observed via “Setpoint temperature feedback send state” parameter as Periodically, On change or both condition.

Via the parameter “Limits for setpoint control,” it is possible to enable a range for the setpoint to be modified. By enabling this option, the minimum and maximum setpoints available to send via KNX will be defined in the parameters “Setpoint lower limit” and “Setpoint higher limit”. By disabling this option, per default, the lower and higher limits will be limits of the air condition unit.

Via the object “Setpoint Temperature +/-” the setpoint temperature can be modified via a 1-bit object as follow:

- By sending “Up” (Value 0) or “Increase” (Value 1): The setpoint temperature will be increased by steps of 1°C until air condition unit limit or defined higher limit value.
- By sending “Down” (Value 1) or “Decrease” (Value 0): The setpoint temperature will be decreased by steps of 1°C until the air condition unit lower the limit value.

Important Notes



- **Lowest cooling temperature value is 16 degrees.**
- **Highest heating temperature value is 30 degrees.**

Special Notes



When the “Setpoint temperature limit control” parameter has enabled, It only valid while using communication object. This parameter does not valid setpoint temperature defined in scene or others.

3.6.1. Parameters List

PARAMETERS	DESCRIPTION	VALUES
Enable ambient temperature	<p>No Ambient temperature reference has selected from indoor unit sensor.</p> <p>Yes Ambient temperature reference can be selected as “AC Indoor Sensor”, “KNX bus”.</p>	<p>No</p> <p>Yes</p>
Ambient temperature reference	<p>AC Indoor Sensor Ambient temperature reference has selected from indoor unit sensor.</p> <p>KNX bus Ambient temperature supplied from KNX.</p>	<p>AC Indoor Sensor</p> <p>KNX bus</p>
> Ambient temperature feedback send state ^{1,2}	<p>This parameter enables the sending of internal temperature value information.</p> <p>Disabled: Temperature information is not sent. Periodically: Temperature information is sent periodically. On change: Temperature information is sent when there is a change in the temperature value. Periodically and on change: Temperature information is sent periodically and when there is a change in the temperature value.</p>	<p>Disable</p> <p>Periodically</p> <p>On change</p> <p>Periodically and on change</p>
> Feedback sending period ^{2,3}	<p>This parameter sets the sending period of the internal temperature value in seconds.</p>	<p>00:05 ...00:30... 04:15</p>
Setpoint temperature feedback send state	<p>This parameter allows the setpoint temperature sent to the air conditioner or the current setpoint temperature to be sent to the KNX line.</p> <p>Disabled: Temperature information is not sent. Periodically: Temperature information is sent periodically. On change: Temperature information is sent when there is a change in the temperature value. Periodically and on change: Temperature information is sent periodically and when there is a change in the temperature value.</p>	<p>Disable</p> <p>Periodically</p> <p>On change</p> <p>Periodically and on change</p>

> Feedback sending period⁴	This parameter sets the sending period of the setpoint temperature value in seconds.	00:05 .. 04:15
Setpoint temperature +/- object	<p>This parameter enables to change of the desired temperature value as +/- with the 1-bit object.</p> <p>Normal (0-Decrease;1-Increase): Setpoint temperature value increases when sended "1"</p> <p>Inverted (0-Up;1-Down): Setpoint temperature value increases when sended "0"</p>	<p>Disable</p> <p>Normal</p> <p>Inverted</p>
Setpoint temperature limit control	This parameter enables limits for the setpoint temperature value.	<p>Disable</p> <p>Enabled</p>
> Setpoint temperature lower limit⁵	This parameter activates a lower limit for the setpoint temperature value.	18...25
> Setpoint temperature higher limit⁵	This parameter activates a higher limit for the setpoint temperature value.	20...29

¹ This parameter is only visible when the parameter "Enable ambient temperature" is set to "No".

² This parameter is only visible when the parameter "Ambient temperature reference" is set to "AC indoor sensor".

³ This parameter is only visible when the parameter "Ambient temperature feedback send state" is set to "Periodically" or "Periodically and on change".

⁴ This parameter is only visible when the parameter "Setpoint temperature feedback send state" is set to "Periodically" or "Periodically and on change".

⁵ This parameter is only visible when the parameter "Setpoint temperature limit control" is set to "Enabled".

3.7. Air Deflectors

On this parameter page, all the parameters are related to the air deflector properties and communication objects. The parameter “Air deflector control” defines if the air deflector control is available in the indoor unit. If this parameter is set to “Disable”, all the fan parameters and objects are hidden.

General	Control
Logic Gate	Air deflector control <input type="radio"/> Disable <input checked="" type="radio"/> Enable
Converter	Air deflector control +/- object <input type="text" value="Normal"/>
Operating Mode	Include 'SWING' mode in the sequence <input checked="" type="radio"/> No <input type="radio"/> Yes
Fan Speed	Loop the sequence <input checked="" type="radio"/> No <input type="radio"/> Yes
Temperature	Feedback
Air Deflectors	Air deflector feedback <input checked="" type="radio"/> Disable <input type="radio"/> Enable
Scenes	
Special	
Digital Input	

Fig. 16: Air Deflector Configuration Parameter Page

Important Notes



- This function can be named as vertical louver, flaps or airflow direction in air conditioner manuals.
- Air deflector cannot be set when AC is OFF.
- This gateway and the some wired remote controller is unable to control horizontal swing in indoor unit.



Air Deflector Control:

The air deflector position can be set via some different methods:

- Air deflector position can be controlled by sending 1-bit values via “Air Deflector +/-” object. While using this method the following sequence is applied:

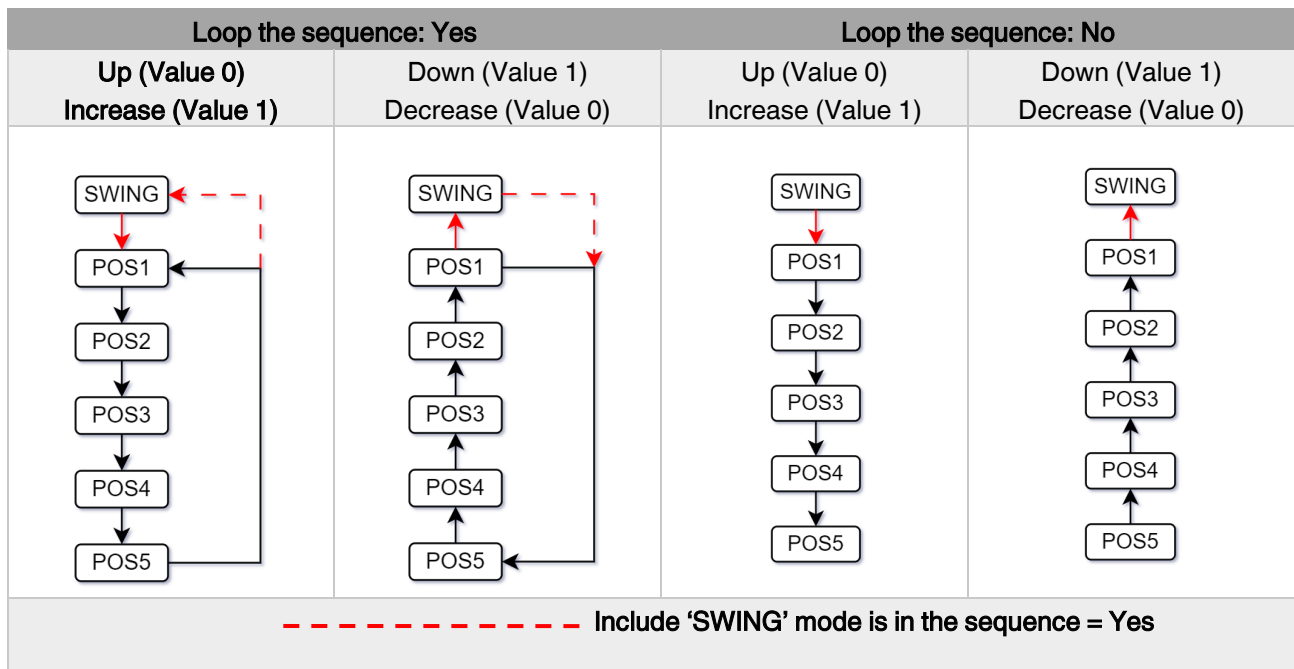

- Air deflector positions can be controlled by sending the numbers of each position: 1, 2, 3, 4 or 5 via “Air Deflector Broadcast Value” communication objects.

Special Notes



If a value greater than 5 , this data will be discarded and the vanes will remain in the current position.

Special Notes



Any modification on all above objects will be advised in the following feedback object:
Air Deflector Feedback

3.7.1. Parameters List

PARAMETERS	DESCRIPTION	VALUES
Air deflector control	<p>This parameter is used to enable or disable the air deflector control function. If this parameter is selected as Enable, all of the air deflector parameters will be visible and air deflector can be control via 1 Byte communication object.</p> <p>Via 1 Byte object, if value 1 is sent air deflector position will be position 1. Likewise, value 2 causes air deflector position 2 and so on.</p>	<p>Disable</p> <p>Enable</p>
Air deflector control +/- object	<p>This parameter is used to enable the air deflector control object to change the desired air deflector position.</p> <p>Normal (0-Decrease;1-Increase): If the value 1 is sent, the air deflector position switches according to the following sequence</p> <p>Swing->Pos 1->Pos 2->Pos 3->Pos 4->Pos 5.</p> <p>Inverted (0-Up;1-Down): If the value 0 is sent, the air deflector position switches according to the following sequence</p> <p>Swing->Pos 1->Pos 2->Pos 3->Pos 4->Pos 5.</p>	<p>Disabled</p> <p>Normal</p> <p>Inverted</p>
> Include 'SWING' mode in the sequence¹	<p>This parameter is used to include the SWING function in the air deflector position sequence. If air deflector position is selected as 1, the SWING feature will come from before the pos 1 in the sequence.</p>	<p>No</p> <p>Yes</p>
> Loop the sequence¹	<p>This parameter is used to control the sequence in a loop. According to air deflector position +/- object configuration polarity, the sequence will be repeated.</p>	<p>No</p> <p>Yes</p>
Air deflector feedback	<p>This parameter enables feedback object.</p>	<p>Disabled</p> <p>Enable</p>

¹ This parameter is only visible when the parameter "Air deflector control +/- object" is set to "Normal" or "Inverted".

3.8. Scenes

On this parameter page, up to 5 different scenarios can be configured. Each scene functions are identical and the configuration of each scene permits:

- The number of scenes (Between 1-64) can be assigned.
- The air condition unit's on/off values can be set.
- The air condition unit's AC mode can be configured.
- Fan levels of the related scene can be specified.
- The setpoint temperature can be set of the scene.
- The scene can be stored by enabling the storage function.
- Delay time can be specified for starting the scene.

General	SCENE 1	<input type="radio"/> Disable <input checked="" type="radio"/> Enable
Logic Gate	Number	1
Converter	Ac On/Off	AC Off
Operating Mode	Ac mode	Fan
Fan Speed	Ac fan speed	Auto
Temperature	Ac setpoint temperature (°C)	20
Air Deflectors	Storage function	<input checked="" type="radio"/> Disable <input type="radio"/> Enable
	Delay	00:05 mm:ss
	Activation object	<input checked="" type="radio"/> Disable <input type="radio"/> Enable
Scenes		
Special	SCENE 2	<input checked="" type="radio"/> Disable <input type="radio"/> Enable
Digital Input	SCENE 3	<input checked="" type="radio"/> Disable <input type="radio"/> Enable
	SCENE 4	<input checked="" type="radio"/> Disable <input type="radio"/> Enable
	SCENE 5	<input checked="" type="radio"/> Disable <input type="radio"/> Enable

Fig. 17: Scenes Configuration Parameter Page

Via the object “Scene”, telegrams that contains the call or store functions of a scene are sent. Up to 1...64 scenario numbers can be selected for 5 scenarios via a single group address. The scenario number telegram must match the pre-configured scenario number in the parameters.

The scene number (1-64), is used to recall the scene via the corresponding object. For storage of the scene, the value sent via the object “Scene” must be 128+scene number. The recall of each scene can be delayed whether a time delay has been previously defined in the parameter window.

Special Notes



After ETS programming, the scene values parameterized for the output concerned will be overwritten into the gateway. It means that any change made by the user will be deleted. Therefore, it is important, before any maintenance, to know the previous scene configuration and whether the user wants to keep operating with that configuration.

3.8.1. Parameters List

PARAMETERS	DESCRIPTION	VALUES
Scene X	This parameter is used to enable or disable the related scenario.	Disable Enable
> Number	This parameter is used to specify the scene number of the corresponding scene.	1...64
> AC On/Off	This parameter is used to determine the on/off status of the air condition unit for the selected scenario.	AC Off AC On No Change
> AC mode	This parameter is used to specify the mode of the air condition unit for the selected scenario.	Auto Heating Cooling Fan Dry No Change
> AC Fan level	This parameter is used to specify the fan level of the air condition unit for the selected scenario.	Auto Level 1 Level 2 Level 3 Level 4 Level 5 No Change
> AC setpoint temperature(°C)	This parameter is used to specify the setpoint temperature of the selected scenario.	18°C...29°C
> Storage function	This parameter is used to save the selected scenario.	Disable Enable
> Delay	This parameter is used to set a delay time for starting the selected scene.	00:05 ... 04:15
> Activation object	This parameter is used to enable or disable the activation object to activate the scenario.	Disable Enable

3.9. Special

In this section, special functionalities of the gateway are described. The gateway has 4 different functions for special purposes. Each of them is explained in separate subtitles.

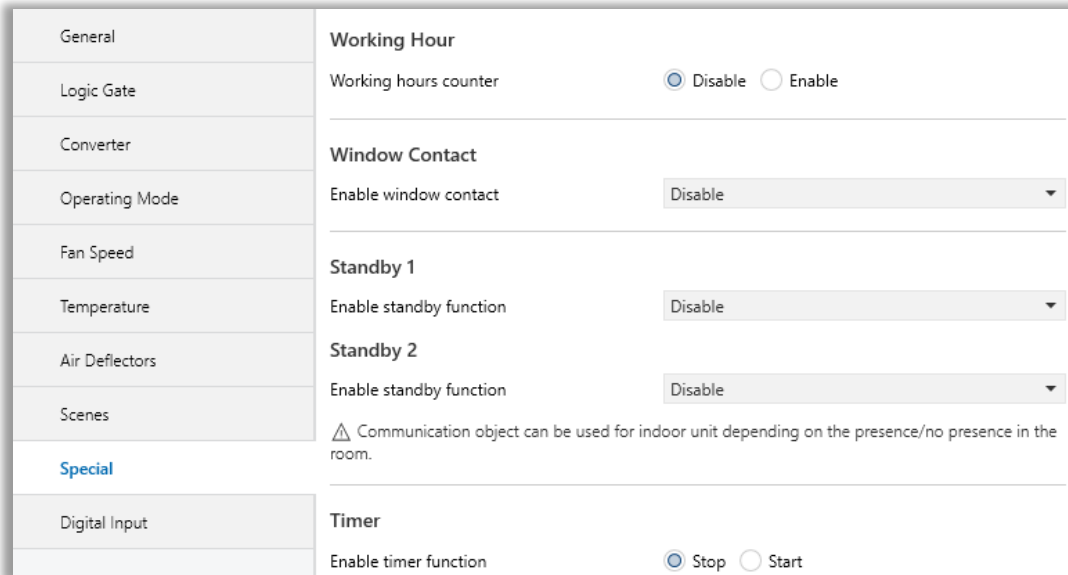

Fig. 18: Special Configuration Parameter Page

Working Hour. This function is used to know the air conditioner’s operating hour as “ON” position. When the “ON” status of the air condition unit is counted for one hour, the object value increases. The counter is available to create an alert to warn the user after the desired time later. The counter can be reset via the “Reset Hours Counter” object.

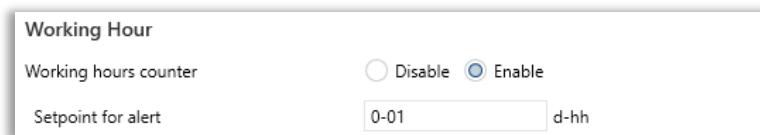

Fig. 19: Working Hour Configuration Parameter Page

Window Contact. This function is used for window contacts to determine the operation type when the window contacts are open or close. When the “window is open” information is received, it is possible to switch off the air condition unit or activate any predefined scene. However, it is possible to specify a delay time for the operation type to be started or to restrict the On / Off action of the air condition unit. After incoming “window contacts are closed” information, the behaviour of the air condition unit can be selected as one of the predefined scenarios, OFF or the previous state of this function.

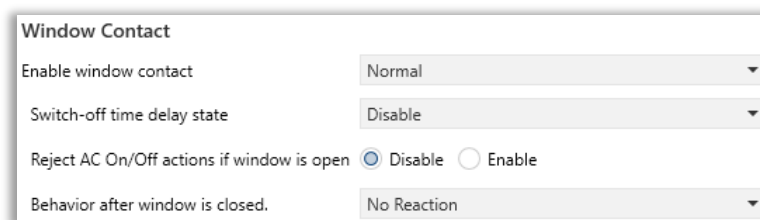

Fig. 20: Window Contact Configuration Parameter Page

Standby Function: This function is used to activate the standby modes for the air condition unit to determine the operation type for the standby modes. During standby function, it is possible to make setpoint shifting, activate any predefined scene or switch off the air condition unit. However, it is possible to specify delay time for operation type to be started or to reject modifications for the air condition unit during standby function. After incoming standby function stop information, the behaviour of the air condition unit can be selected as one of scenario, off or the previous state. Additionally, a secondary standby function is available and the same parameters and object are valid for the secondary standby function. If Standby function is enabled, any command received from the KNX Bus will stop the Standby Function.

Standby 1	
Enable standby function	Start-1;Stop-0
Standby function delay state	Disable
Behavior during standby function	Setpoint Temp Shift
Setpoint temperature shifting state	Disable
Reject modifications during standby	<input checked="" type="radio"/> Disable <input type="radio"/> Enable
Behavior after standby function	No Reaction

Fig. 21: Standby X Configuration Parameter Page

Timer Function: The timer function switches off the air condition unit after a defined time. Polarity and durations can be determined via sub-parameters of this function. The timer function is also retriggerable and when timer retrigger is enabled, the timer restarts itself for counting for switch off the air condition unit.

Timer	
Enable timer function	<input type="radio"/> Stop <input checked="" type="radio"/> Start
Polarity	<input checked="" type="radio"/> Normal <input type="radio"/> Inverted
Timer duration state	<input checked="" type="radio"/> Via parameter <input type="radio"/> Via Communication Object
Timer duration	01:00 hh:mm
Timer retriggerable	<input checked="" type="radio"/> No <input type="radio"/> Yes

Fig. 22: Timer Configuration Parameter Page

3.9.1. Parameters List

PARAMETERS	DESCRIPTION	VALUES
Working Hour	This parameter is used to enable or disable the working hours counter function.	Disable Enable
> Setpoint for alert ¹	This parameter is used to set a setpoint alarm point for the working hours counter of the air conditioner unit.	0-01 ... 9-23 d-hh
Enable window contact	This parameter is used to enable or disable the air conditioner unit's window contact function. Normal: 0-Opened;1-Closed Inverted: 0-Closed;1-Opened	Disable Normal Inverted
> Switch-off time delay state ²	This parameter is used to specify the switch-off time delay that is sent via parameter or communication object.	Disable Via parameter Via communication object
> Switch-off time delay ^{2,3}	This parameter is used to set delay time in minutes to switch off the air conditioner.	00:01 ... 04-15 hh:mm
> Reject AC On/Off actions if window is open ²	This parameter is used to reject on & off actions of the air conditioner unit's when the window is opened.	Disable Enable
> Behaviour after window is closed. ²	This parameter is used to specify the behaviour after window is closed. For instance, one of the configured scenarios can be operated, the conditioner unit is turned off or the last state is maintained.	No Reaction Last State AC ON AC OFF Scene
> After window is closed scene. ^{2,4}	This parameter is used to activate defined scene if "Behaviour after window is closed" parameter is selected as "Scene"	Scene 1 Scene 2 Scene 3 Scene 4 Scene 5

<p>Enable standby function</p>	<p>This parameter is used to enable or disable the standby function.</p> <p>Occupied-1;Not occupied-0: According to occupied or not occupied status, configurations can be made. This can be used for indoor unit depending on the presence/ no presence in the room.</p> <p>Start-1;Stop-0: This function is used in order to activate standby function.</p>	<p>Disabled</p> <p>Occupied-1;Not occupied-0</p> <p>Start-1;Stop-0</p>
<p>> Standby function delay state⁵</p>	<p>This parameter is used to specify the standby function delay that is sent via parameter or communication object.</p>	<p>Disable</p> <p>Via parameter</p> <p>Via communication object</p>
<p>> Standby function delay⁶</p>	<p>This parameter is used to set a delay time in minutes for the standby function.</p>	<p>00:01 ... 04-15 hh:mm</p>
<p>> Behaviour during standby function⁵</p>	<p>This parameter is used to configure the behaviour during the standby function. For instance, one of the configured scenarios can be operated, the conditioner unit is turned off or the last state is maintained.</p>	<p>Setpoint shifting</p> <p>Off</p> <p>Scene</p>
<p>> Standby function scene⁶</p>	<p>This parameter is used to activate defined scene if “Behaviour during standby function” parameter is selected as “Scene”</p>	<p>Scene 1</p> <p>Scene 2</p> <p>Scene 3</p> <p>Scene 4</p> <p>Scene 5</p>
<p>> Setpoint temperature shifting state⁷</p>	<p>This parameter is used to specify the setpoint shifting that is sent via parameter or communication object.</p>	<p>Disable</p> <p>Via parameter</p> <p>Via communication object</p>
<p>> Setpoint temperature shifting (°C)⁸</p>	<p>This parameter is used to set the setpoint shifting temperature value.</p>	<p>0...5</p>
<p>> Reject modifications during standby function⁵</p>	<p>This parameter is used to enable or disable the reject modifications during the standby function. If this parameter is enabled, no modifications can be allowed in standby mode. User can not sends command to air conditioner.</p>	<p>Disable</p> <p>Enable</p>

<p>> Behaviour after standby function⁵</p>	<p>This parameter is used to configure the behaviour during the standby function. For instance, one of the configured scenarios can be operated, the conditioner unit is turned off or the last state is maintained.</p>	<p>No reaction</p> <p>Last state</p> <p>AC ON</p> <p>AC OFF</p> <p>Scene</p>
<p>> Standby function scene⁶</p>	<p>This parameter is used to activate defined scene if “Behaviour after standby function” parameter is selected as “Scene”</p>	<p>Scene 1</p> <p>Scene 2</p> <p>Scene 3</p> <p>Scene 4</p> <p>Scene 5</p>
<p>Enable timer function</p>	<p>This parameters is used for start or stop timer function.</p>	<p>Stop</p> <p>Start</p>
<p>> Polarity⁹</p>	<p>This parameter is used to specify the polarity of enabling command the timer function.</p> <p>Normal: 0-Stop; 1-Start Inverted: 0-Start; 1-Stop</p>	<p>Normal</p> <p>Inverted</p>
<p>> Timer duration state⁹</p>	<p>This parameter is used to specify the timer duration that is sent via parameter or communication object.</p>	<p>Via parameter</p> <p>Via communication object</p>
<p>> Timer duration¹⁰</p>	<p>This parameter is used to set delay time in minutes for the timer function.</p>	<p>00:01... 23:59 hh:mm</p>
<p>> Timer retriggerable⁹</p>	<p>This parameter is used to restart the timer.</p>	<p>No</p> <p>Yes</p>

¹ This parameter is only visible when the parameter “Working Hour” is set to “Enable”.

² This parameter is only visible when the parameter “Enable window contact” is set to “Normal” or “Inverted”.

³ This parameter is only visible when the parameter “Switch-off time delay state” is set to “Via parameter”.

⁴ This parameter is only visible when the parameter “Behaviour after window is closed” is set to “Scene”.

⁵ This parameter is only visible when the parameter “Enable standby function” is set to “Occupied-1;Not occupied-0” or “Start-1;Stop-0”.

⁶ This parameter is only visible when the parameter “Behaviour during standby function” is set to “Scene”.

⁷ This parameter is only visible when the parameter “Behaviour during standby function” is set to “Setpoint shifting”.

⁸ This parameter is only visible when the parameter “Setpoint temperature shifting state” is set to “Via parameter”.

⁹ This parameter is only visible when the parameter “Enable timer function” is set to “Start”.

¹⁰ This parameter is only visible when the parameter “Timer duration state” is set to “Via parameter”.

3.10. Digital Input

This function is used to perform the switching operation. Depending on the settings configured in the switching process, when the button is pressed or released, the ON or OFF values are generated. After each operation, a telegram is sent to the KNX bus line. Telegram is generated based on the configured settings.

General	⚠ This parameters are only valid for product models with digital input available.	
Logic Gate	Enable digital input 1	<input type="radio"/> Disable <input checked="" type="radio"/> Enable
Converter	Distinction between long and short operation	<input checked="" type="radio"/> No <input type="radio"/> Yes
Operating Mode	Cyclic sending of object "Switch"	no ▾
Fan Speed	Reaction on closing the contact (falling edge)	no reaction ▾
Temperature	Reaction on opening the contact (rising edge)	no reaction ▾
Air Deflectors	Scan input after bus voltage recovery	<input checked="" type="radio"/> No <input type="radio"/> Yes
Scenes	Debounce Time	10 ms ▾
Special	Enable digital input 2	<input checked="" type="radio"/> Disable <input type="radio"/> Enable
Digital Input	Enable digital input 3	<input checked="" type="radio"/> Disable <input type="radio"/> Enable

Fig. 23: Digital Input Configuration Parameter Page

Special Notes



When the "Scan input after bus voltage recovery" parameter is set to "Yes," it reports the last state of the input after a bus voltage failure. If the "Toggle" option is selected for any press condition, the device assumes that no change has occurred after the fault and resets the product to the default (off) position. Additionally, it does not provide any feedback about the input's status.

3.10.1. Parameters List

PARAMETERS	DESCRIPTION	VALUES
Enable digital input X	This parameter is used to enable or disable the digital inputs. Other parameters will be shown when this parameter is enabled.	Disable Enable
Distinction between long and short operation	This parameter is used to set if the input differentiates between short and long operations. With the option "yes", after opening/closing of the contract, it must, first of all, be ascertained if a short or long operation has occurred here. Only thereafter will a possible reaction be triggered.	No Yes
Cyclic sending of object "Switch"	This parameter is used to periodically send the commands to the bus line.	No If "Switch" = ON If "Switch" = OFF Always
-> Telegram repeated every ₁	This parameter is visible if the cyclical transmission is active. The send cycle time describes the time used between two cyclically transmitted telegrams	00:00 ... 59:59
Reaction on closing the contact (falling edge)	This parameters is used to determine the action on state of falling edge of button.	No reaction On Off Toggle
Reaction on closing the contact (rising edge)	This parameters is used to determine the action on state of rising edge of button.	No reaction On Off Toggle
Scan input after bus voltage recovery	When the power voltage arrives, it remembers the last states of the inputs.	No Yes
Debounce Time	Switching time duration.	10 ms 20 ms 30 ms 40 ms 50 ms 70 ms 100 ms 150 ms

Connected contact type	This function is used to determine the contact type of connected switch.	Normally closed Normally open
Reaction on short operation	It is used to determine the "short press operation" when 1 bit object value has transmitted to bus.	No reaction On Off Toggle
Reaction on long operation	It is used to determine the "long press operation" when 1 bit object value has transmitted to bus.	No reaction On Off Toggle
Long operation after	This parameter is used to determine switching status as long or short. For making a long operation, the button should be pressed at least the configured value.	00:00.300 ... 00:00.500 ... 01.5.535
Number of object for short/long operationg	This parameter is used to determine the object count to use for short and long operations. 1 object: short and long operations will proceed with the same object. 2 objects: short and long operations will proceed with 2 different objects.	1 object 2 objects

*1 This parameter is only visible when the parameter "Cyclic sending of object "Switch" is set to "If "Switch" = ON" or "If "Switch" = OFF" or "Always".

4. ETS Objects List & Descriptions

The Vaillant VRF AC - KNX Gateway can communicate via the KNX bus line. In this section, the group objects of the Vaillant VRF AC - KNX Gateway are described.

ETS group objects are divided into 10 main parts, and these are :

- ❖ **General** - General group objects to the Vaillant VRF AC - KNX Gateway.
- ❖ **Logic Gate** - These objects are related to logic gate parameters.
- ❖ **Converter** - These objects are related to converter parameters.
- ❖ **Operating Mode** - These objects are related to operating mode parameters.
- ❖ **Fan Speed** - These objects are related to fan parameters.
- ❖ **Temperature** - These objects are related to temperature parameters
- ❖ **Air Deflectors** - These objects are related to air deflector parameters.
- ❖ **Scenes** - These objects are related to scenes parameters.
- ❖ **Special** - These objects are related to special functions.
- ❖ **Digital input** - These objects are related to digital input functions.

Special Note



Due to the flexible ETS configurations feature, some group objects are dynamic and they are only visible if the related parameters are activated in the application program.

All of the group objects of Interra Vaillant VRF AC - KNX Gateway are listed below. You can quickly browse through this table to get the functional capabilities of Interra Vaillant VRF AC Gateway. The device can operate up to 16 indoor units. Each indoor unit has its own individual communication objects.

The detailed functions of group objects are described in different topics.

No	Name	Function	DTP Type	Length	Flags				
					C	R	W	T	U
1	Alive Beacon	Alive Beacon	1.002	1 Bit	X			X	
2,7, 12,17	Logic 1...4 – Input 1	Logic Input	1.002	1 Bit	X	X	X		
3,8, 13,18	Logic 1...4 – Input 2	Logic Input	1.002	1 Bit	X	X	X		
4,9, 14,19	Logic 1...4 – Input 3	Logic Input	1.002	1 Bit	X	X	X		
5,10, 15,20	Logic 1...4 – Input 4	Logic Input	1.002	1 Bit	X	X	X		
6,11, 16,21	Logic 1...4 – Output	Logic Output	1.002	1 Bit	X	X		X	
22,23, 24,25/ 30,31, 32,33/ 78,79, 80,81	Converter X - Input	Converter Input	1.006	1 Bit	X	X	X		
			2.006	2 Bit	X	X	X		
			5.010	1 Byte	X	X	X		
			7.001	2 Bytes	X	X	X		
26,27, 28,29/ 34,35, 36,37/ 82,83, 84,85	Converter X - Output	Converter Output	1.006	1 Bit	X	X	X	X	
			2.006	2 Bit	X	X	X	X	
			5.010	1 Byte	X	X	X	X	
			7.001	2 Bytes	X	X	X	X	
86	OnOff	0-Off ;1-On	1.001	1 Bit	X		X		
87	OnOff_Feedback	0-Off;1-On	1.001	1 Bit	X	X		X	
88	Operating_Mode	0-Auto;1-Heat;3-Cool;9-Fan;14-Dry	20.105	1 Byte	X		X		
89	Operating_Mode_Feedback	0-Auto;1-Heat;3-Cool;9-Fan;14-Dry	20.105	1 Byte	X	X		X	
90	Mode Cool/Heat	0-Cool;1-Heat	1.100	1 Bit	X		X		
	Mode Heat/Cool	0-Heat;1-Cool	1.100	1 Bit	X		X		
91	Mode Cool/Heat Feedback	0-Heat;1-Cool	1.100	1 Bit	X	X		X	
	Mode Heat/Cool Feedback	0-Cool;1-Heat	1.100	1 Bit	X	X		X	
92	Mode Heating_Percentage	0%-Off;1%-100%-On+Heat	5.001	1 Byte	X		X		
93	Mode Cooling_Percentage	0%-Off;1%-100%-On+Cool	5.001	1 Byte	X		X		
94	Mode Auto	1-Set AUTO mode	1.002	1 Bit	X		X		
95	Mode Auto Feedback	1-AUTO mode	1.002	1 Bit					
96	Mode Heat	1-Set HEAT mode	1.002	1 Bit	X		X		
97	Mode Heat Feedback	1-HEAT mode	1.002	1 Bit	X	X		X	
98	Mode Cool	1-Set COOL mode	1.002	1 Bit	X		X		
99	Mode Cool Feedback	1-COOL mode	1.002	1 Bit	X	X		X	
100	Mode Fan	1-Set FAN mode	1.002	1 Bit	X	X			
101	Mode Fan Feedback	1-FAN mode	1.002	1 Bit	X	X		X	
102	Mode Dry	1-Set DRY mode	1.002	1 Bit	X		X		
103	Mode Dry Feedback	1-DRY mode	1.002	1 Bit	X	X		X	
104	Mode +/-	0-Up;1-Down	1.008	1 Bit	X		X		
		0-Decrease;1-Increase	1.008	1 Bit	X		X		
105	Operating Mode Text Feedback	Text Feedback	16.001	14 Bytes	X	X		X	

106	Fan Speed Enumerated	0-Auto;1-Speed1;...5-Speed5;	5.100	1 Byte	X		X		
	Fan Speed Scaling	Threshold Defined in Parameter	5.001	1 Byte	X		X		
107	Fan Speed Scaling Feedback	% Percentage value	5.100	1 Byte	X	X		X	
	Fan Speed Enumerated Feedback	0-Auto;1-Speed1;...5-Speed5;	5.100	1 Byte	X	X		X	
108	Fan Speed 1 Control	1-Set Fan Speed 1	1.002	1 Byte	X		X		
109	Fan Speed 1 Feedback	1-Fan Speed 1	1.002	1 Bit	X	X		X	
110	Fan Speed 2 Control	1-Set Fan Speed 2	1.002	1 Bit	X		X		
111	Fan Speed 2 Feedback	1-Fan Speed 2	1.002	1 Bit	X	X		X	
112	Fan Speed 3 Control	1-Fan Speed Auto	1.002	1 Bit	X		X		
113	Fan Speed 3 Feedback	1-Fan Speed 3	1.002	1 Bit	X	X		X	
114	Fan Speed 4 Control	1-Set Fan Speed 4	1.002	1 Bit	X		X		
115	Fan Speed 4 Feedback	1-Fan Speed 4	1.002	1 Bit	X	X		X	
116	Fan Speed 5 Control	1-Set Fan Speed 5	1.002	1 Bit	X		X		
117	Fan Speed 5 Feedback	1-Fan Speed 5	1.002	1 Bit	X	X		X	
118	Fan Speed Turbo Control	1-Set Fan Speed Turbo	1.002	1 Bit	X		X		
119	Fan Speed Turbo Feedback	1-Fan Speed Turbo	1.002	1 Bit	X	X		X	
120	Fan Speed Auto Control	1-Set Fan Speed Auto	1.002	1 Bit	X		X		
121	Fan Speed Auto Feedback	1-Fan Speed Auto	1.002	1 Bit	X	X		X	
122	Fan Speed +/-	0-Decrease;1-Increase	1.007	1 Bit	X		X		
		0-Up;1-Down	1.008	1 Bit	X		X		
123	Fan Speed Text Feedback	Fan Speed Text	16.001	14 Bytes	X	X		X	
124	Setpoint Temperature Control	°C	9.001	1 Bit	X		X		
125	Setpoint Temperature Feedback	°C	9.001	1 Bit	X	X		X	
126	Setpoint Temperature +/-	0-Decrease;1-Increase	1.007	1 bit	X		X		
		0-Up;1-Down	1.008	1 Bit	X		X		
127	Ambient Temperature	°C	9.001	2 Bytes	X		X		
128	Ambient Temperature Feedback	°C	9.001	2 Bytes	X		X	X	
129	Air Deflector Broadcast Value	0-Swing;1-Pos1;...5-Pos5	Non DPT	1 Byte	X		X		
130	Air Deflector +/-	0-Up;1-Down	1.008	1 Bit	X		X		
		0-Decrease;1-Increase	1.007	1 Bit	X		X		
131	Air Deflector Feedback	0-Swing;1-Pos1;...5-Pos5	Non DPT	1 Byte	X	X		X	
132	Window Contact Status	0-Opened;1-Closed	1.009	1 Bit	X	X	X	X	
		0-Closed;1-Opened	1.019	1 Bit	X	X	X	X	
133	Window Contact Off Delay	Values are accepted according to the data type of 20.013	20.013	1 Byte	X		X		
134	Standby 1 Function	0-Stop;1-Start	1.010	1 Bit	X		X		
		0-Not occupied;1-Occupied	1.018	1 Bit	X		X		
135	Standby 1 Feedback	0-Stop;1-Start	1.010	1 Bit	X	X		X	
		0-Not occupied;1-Occupied	1.018	1 Bit	X	X		X	
136	Standby 1 Delay	Values are accepted according to the data type of 20.013	20.013	1 Byte	X		X		
137	Standby 1 Setpoint Shifting	°C	9.001	2 Bytes	X		X		
138	Standby 2 Function	0-Not occupied;1-Occupied	1.018	1 Bit	X		X		
		0-Start;1-Stop	1.010	1 Bit	X		X		

139	Standby 2 Feedback	0-Not occupied;1-Occupied	1.018	1 Bit	X	X		X	
		0-Stop;1-Start	1.010	1 Bit	X	X		X	
140	Standby 2 Delay	Values are accepted according to the data type of 20.013	20.013	1 Byte	X		X		
141	Standby 2 Setpoint Shifting	°C	9.001	2 Bytes	X		X	X	
142	Timer State	0-Stop;1-Start	1.010	1 Bit	X		X	X	
		0-Start;1-Stop	1.010	1 Bit	X		X	X	
143	Timer State Feedback	0-Start;1-Stop	1.010	1 Bit	X	X		X	
		0-Stop;1-Start	1.010	1 Bit	X	X		X	
144	Timer Duration	Values are accepted according to the data type of 20.013	20.013	1 Byte	X	X		X	
145	Scene	0-63 (Execute 1-64); 128-191 (Storage 1-64)	18.001	1 Byte	X	X		X	
146	Scene 1 Run	0-Nothing;1-Run Scene	1.002	1 Bit	X		X	X	
147	Scene 1 Storage	0-Nothing;1-Storage Scene	1.002	1 Bit	X	X		X	
148	Scene 2 Run	0-Nothing;1-Run Scene	1.002	1 Bit	X	X		X	
149	Scene 2 Storage	0-Nothing;1-Storage Scene	1.002	1 Bit	X	X		X	
150	Scene 3 Run	0-Nothing;1-Run Scene	1.002	1 Bit	X		X		
151	Scene 3 Storage	0-Nothing;1-Storage Scene	1.002	1 Bit	X		X	X	
152	Scene 4 Run	0-Nothing;1-Run Scene	1.002	1 Bit	X		X	X	
153	Scene 4 Storage	0-Nothing;1-Storage Scene	1.002	1 Bit	X		X	X	
154	Scene 5 Run	0-Nothing;1-Run Scene	1.002	1 Bit	X		X	X	
155	Scene 5 Storage	0-Nothing;1-Storage Scene	1.002	1 Bit	X		X	X	
156	Current Scene Feedback	1-64:Current Scene	17.001	1 Byte	X	X		X	
157	Device Control Locking	0-Enable;1-Disable	1.003	1 Bit	X	X		X	
158	Error Alarm Feedback	0-No Alarm;1-Alarm	1.005	1 Bit	X	X		X	
159	Error Code Feedback	Error Code Information	Non DPT	2 Bytes	X	X		X	
160	Error Code Text Feedback	Error Text Information	16.001	14 Bytes	X	X		X	
161	Working Hour Counter Feedback	Working Hours Counter Feedback	13.100	4Bytes	X	X		X	
162	Working Hour Alert Feedback	0-No Alarm;1-Alarm	1.005	1Bit	X	X		X	
163	Reset Hours Counter	0-No Action;1-Reset	1.015	1Bit	X		X		
164, 167, 170	Input 1,2,3	Block	1.003	1 Bit	X	X			
165, 168, 171	Input 1,2,3	Switch	1.001	1 Bit	X	X	X	X	
166, 169, 172	Input 1,2,3	Switch - Long	1.001	1 Bit	X	X	X	X	

4.1. General Objects

This section describes the "General" group objects and their properties. General group objects, as the name suggests, indicate the general characteristics of the Gateway.

Object Number	Object Name	Function	Type	Flags
1	Alive beacon	1:True/0:False	1 bit	CT

This object is used to monitor the presence of the device on the KNX bus line regularly. However, monitoring telegrams can be sent cyclically on the KNX bus line. This object appears only the "Alive beacon state" parameter is enabled.

DPT: 1.002 (Boolean)

86	OnOff	1:On/0:Off	1 bit	CW
----	-------	------------	-------	----

This object is used to turn the Gateway on or off. Also, this object is visible permanently. If you associate the desired group address, Gateway can be controlled with On and Off.

DPT: 1.001 (Switch)

87	OnOff_Feedback	1:On/0:Off	1 bit	CRT
----	----------------	------------	-------	-----

This object is used to check the status of the air conditioner unit. Also, this object is visible permanently. If you associate the desired group address, Gateway's ON and OFF status can be monitored.

DPT: 1.001 (Switch)

156	Error Alarm Feedback	1:Alarm/0:No Alarm	1 bit	CRT
-----	----------------------	--------------------	-------	-----

This object is used to check the status of the air conditioner unit's error alarm. Also, this object is visible permanently. If there is an error alarm and a group address is associated with the corresponding object, the alarm can be monitored.

DPT: 1.005 (alarm)

157	Error Code Feedback	Error Code Information	2 bytes	CRT
-----	---------------------	------------------------	---------	-----

This object is used to give information about the error codes. This functionality allows sending messages to the KNX bus informing about errors. Errors management handles air conditioner unit error codes as well as any communication errors that may arise. For more detailed information check the section APPENDIX.

DPT: non DPT

158	Error Code Text Feedback	Error Text Information	14 bytes	CRT
------------	---------------------------------	-------------------------------	-----------------	------------

This object is used to give information about the 2 Byte error codes in string format.

DPT: 16.001 (Character String) (ISO 8859-1)

155	Device Control Locking	1:Enabled / 0:Disabled 0:Enabled / 1:Disabled	1 bit	CRT
------------	-------------------------------	----------------------------------------------------------	--------------	------------

This object is used to lock the gateway device. When a value that predetermined from parameter is sent to this communication object, the gateway is locked. If a value is sent to the gateway via its communication objects, all values are ignored. For unlocking the gateway, a opposite value of determined from parameter must be sent.

DPT: 1.003 (Enable)

4.2. Logic Gate Objects

This section describes the "Logic Gate" group objects and their properties. Logic Gate group objects, as the name suggests, indicate the logical operations that can be made with Gateway.

Object Number	Object Name	Function	Type	Flags
2 , 3 , 4 , 5 , 7 8 , 9 , 10 ,12 13 , 14 , 15 , 17 , 18 , 19 ,20	Logic X – Input 1 Logic X – Input 2 Logic X – Input 3 Logic X – Input 4	Logic Input	1 bit	CRW

This object is used to set the inputs of the logical gate to be used. Logical associations can be made over 1-bit values. The result is obtained according to the type of logical gate selected.

DPT: 1.002 (Boolean)

6 , 11 , 16 , 21	Logic X – Output	Logic Output	1 bit	CRT
------------------	------------------	--------------	-------	-----

This object is used to obtain the result of the logical gate to be used. The output value of the logical gate is 1 bit. The result is obtained according to the type of logical gate selected.

DPT: 1.002 (Boolean)

Special Notes



This is a fully compatible KNX device that must be configured and set up using the standard KNX tool ETS. Up to 4 different logic gates can be selected. Each logic gate can be set independently.

4.3. Converter Objects

This section describes the "Converter" group objects and their properties. Converter group objects are used to make mathematical operations and data converting from different types. Up to 8 different converters can be configured.

Object Number	Object Name	Function	Type	Flags
22,23,24,25/ 30,31,32,33/.... 78,79,80,81	Converter X – Input (1 Bit)	Converter Input	1 bit	CRW
	Converter X – Input (2 Bits)		2 bits	
	Converter X – Input (1 Byte)		1 byte	
	Converter X – Input (2 Bytes)		2 bytes	

This object is used to set the converter inputs to be used. The conversion processes can be made via 1 bit, 2 bit, 1 byte and 2-byte values. The result is obtained according to the input type of the selected converter.

DPT:

1 Bit (1.006 Binary Value)

2 Bits (2.006 Binary Value)

1 Byte (5.010 Counter Pulses (0...255))

2 Bytes (7.001 Pulses)

26,27,28,29/ 34,35,36,37/.... 78,79,80,81	Converter X – Output (1 Bit)	Converter Output	1 bit	CRWT
	Converter X – Output (2 Bits)		2 bits	
	Converter X – Output (1 Byte)		1 byte	
	Converter X – Output (2 Bytes)		2 bytes	

This object is used to obtain the result of the converter to be used. The output value of the converter can be 1 bit, 2-bit, 1 byte and 2 bytes. The result is obtained according to the configuration of the selected converter.

DPT:

1 Bit (1.006 Binary Value)

2 Bits (2.006 Binary Value)

1 Byte (5.010 Counter Pulses (0...255))

2 Bytes (7.001 Pulses)

4.4. Operating Mode Objects

This section describes the "Operating Mode" group objects and their properties. Heat, cool, dry and fan mode communication objects are described. Also, simple heating-cooling objects are clarified.

Object Number	Object Name	Function	Type	Flags
88	Operating_Mode	0-Auto;1-Heat;3-Cool;9-Fan;14-Dry	1 byte	CWRT

This object is used to set the operating modes of the air conditioner. You can select AUTO with 0, HEAT with 1, COOL with 3, FAN with 9, and DRY with 14.

DPT: 20.105 (HVAC Control Mode)

89	Operating_Mode_Feedback	0-Auto;1-Heat;3-Cool;9-Fan;14-Dry	1 byte	CRT
----	-------------------------	-----------------------------------	--------	-----

This object is used to monitor the status of the operating modes of the air conditioner. With value 0 the status is AUTO, value 1 the status is HEAT, with value 3 status is COOL, with value 9 the status is FAN and with value 14 the status is DRY can be understood.

DPT: 20.105 (HVAC Control Mode)

90	Mode Cool/Heat	0-Cool;1-Heat 0-Heat;1-Cool	1 bit	CW
----	----------------	--------------------------------	-------	----

This object is used to set the operating mode of the air conditioner unit. When selecting this option, the related 1-bit object will be enabled. It allows establishing the desired mode: Cool mode, writing the value "0" in the object and Heat mode, writing the value "1" or vice versa.

DPT: 1.100 (Cooling/Heating)

91	Mode Cool/Heat Feedback	0-Cool;1-Heat 0-Heat;1-Cool	1 bit	CRT
----	-------------------------	--------------------------------	-------	-----

This object is used to check the operating mode of the air conditioner unit.

DPT: 1.100 (Cooling/Heating)

92	Mode Heating_Percentage	0%-Off;1%-100%-On+Heat	1 byte	CW
-----------	--------------------------------	-------------------------------	---------------	-----------

This object is used to change operating mode to heat via incoming percentage value. It also provides compatibility with KNX thermostats that control the demand for heating or cooling by using percentage values. In these thermostats, the percentage demand is meant to be applied on a fluid valve of the heating/cooling system. If a non-zero value is received (>0%) the indoor unit will switch on to Heat mode.

DPT: 5.001 (Percentage (0..100%))

93	Mode Cooling_Percentage	0%-Off;1%-100%-On+Cool	1 byte	CW
-----------	--------------------------------	-------------------------------	---------------	-----------

This object is used to change operating mode to cool via incoming percentage value. It also provides compatibility with KNX thermostats that control the demand for heating or cooling by using percentage values. In these thermostats, the percentage demand is meant to be applied on a fluid valve of the heating/cooling system. If a non-zero value is received (>0%) the indoor unit will switch on to Cool mode.

DPT: 5.001 (Percentage (0..100%))

94	Mode Auto	1-Set AUTO mode	1 bit	CW
-----------	------------------	------------------------	--------------	-----------

This object is used to change the air conditioner's operating mode to auto mode via a 1-bit object individually. If the value 1 is sent over the 1-bit value, the air conditioning unit will switch to auto mode.

DPT: 1.002 (Boolean)

95	Mode Auto Feedback	1-AUTO mode	1 bit	CRT
-----------	---------------------------	--------------------	--------------	------------

This object is used to monitor the air condition unit status individually. If value 1 is received from this object, the operating mode is auto.

DPT: 1.002 (Boolean)

96	Mode Heat	1-Set HEAT mode	1 bit	CW
-----------	------------------	------------------------	--------------	-----------

This object is used to change the air conditioner's operating mode to heat mode via a 1-bit object individually. If the value 1 is sent over the 1-bit value, the air conditioning unit will switch to heat mode.

DPT: 1.002 (Boolean)

97	Mode Heat Feedback	1-HEAT mode	1 bit	CRT
-----------	---------------------------	--------------------	--------------	------------

This object is used to monitor the air condition unit status individually. If value 1 is received from this object, the operating mode is heating.

DPT: 1.002 (Boolean)

98	Mode Cool	1-Set COOL mode	1 bit	CW
-----------	------------------	------------------------	--------------	-----------

This object is used to change the air conditioner's operating mode to cool mode via a 1-bit object individually. If the value 1 is sent over the 1-bit value, the air conditioning unit will switch to cool mode.

DPT: 1.002 (Boolean)

99	Mode Cool Feedback	1-COOL mode	1 bit	CRT
-----------	---------------------------	--------------------	--------------	------------

This object is used to monitor the air condition unit status individually. If value 1 is received from this object, the operating mode is cool.

DPT: 1.002 (Boolean)

100	Mode Fan	1-Set FAN mode	1 bit	CW
------------	-----------------	-----------------------	--------------	-----------

This object is used to change the air conditioner's operating mode to fan mode via a 1-bit object individually. If the value 1 is sent over the 1-bit value, the air conditioning unit will switch to fan mode.

DPT: 1.002 (Boolean)

101	Mode Fan Feedback	1-FAN mode	1 bit	CRT
------------	--------------------------	-------------------	--------------	------------

This object is used to monitor the air condition unit status individually. If value 1 is received from this object, the operating mode is the fan.

DPT: 1.002 (Boolean)

102	Mode Dry	1-Set DRY mode	1 bit	CW
------------	-----------------	-----------------------	--------------	-----------

This object is used to change the air conditioner's operating mode to dry mode via a 1-bit object individually. If the value 1 is sent over the 1-bit value, the air conditioning unit will switch to dry mode.

DPT: 1.002 (Boolean)

103	Mode Dry Feedback	1-DRY mode	1 bit	CRT
------------	--------------------------	-------------------	--------------	------------

This object is used to monitor the air condition unit status individually. If value 1 is received from this object, the operating mode is dry.

DPT: 1.002 (Boolean)

104	Mode +/-	0-Decrease;1-Increase	1 bit	CW
------------	-----------------	------------------------------	--------------	-----------

This object changes between operating modes as +/- via 1-bit value. This object is used to switch between the operating modes of the air conditioning unit in a loop. If a continuous value is sent in the increasing direction, it follows the following sequence and returns to the beginning when reaches the last mode.

1:Increase : auto->heat->cool->fan->dry
0:Decrease : dry -> fan -> cool -> heat->auto

DPT: 1.007 (Step)

104	Mode +/-	0-Up;1-Down	1 bit	CWT
------------	-----------------	--------------------	--------------	------------

This object changes between operating modes as +/- via 1-bit value. This object is used to switch between the operating modes of the air conditioning unit in a loop. If a continuous value is sent in the increasing direction, it follows the following sequence and returns to the beginning when reaches the last mode.

0:Up : auto->heat->cool->fan->dry
1:Down : dry -> fan -> cool -> heat->auto

DPT: 1.008 (Up/Down)

105	Operating Mode Text Feedback	Text Feedback	14 bytes	CRT
------------	-------------------------------------	----------------------	-----------------	------------

This object is used to monitor the operation mode of the air conditioning unit in text format via the KNX bus line. Naming can be made for each operating mode with a length of 14 bytes.

DPT: 16.001 (Character String (ISO 8859-1))

4.5. Fan Group Objects

In this section, fan group objects and their properties are described.

Object number	Object Name	Function	Type	Flags
106	Fan Speed Scaling	Threshold defined in parameter	1 byte	CW

This object is used to set fan speeds in percentages. 5 different fan speeds can be configured according to the specified threshold values. For example, select Fan speed 1 lower limit is 30% and Fan speed 2 lower limit is 55%. If a 45% value is sent over this object, fan speed will be fan1.

DPT: 5.001 (Percentage(0...100%))

107	Fan Speed Scaling Feedback	% Percentage value	1 byte	CRT
-----	----------------------------	--------------------	--------	-----

This object gives last value about communication object fan speed scaling percentage.

DPT: 5.001 (Percentage(0...100%))

106	Fan Speed Enumerated	0-Auto;1-Speed1;...6-Turbo	1 byte	CW
-----	----------------------	----------------------------	--------	----

This object is used to determine the fan speed by selecting between 0-5 values. For example, if value 1 is sent, fan speed will be fan 1.

DPT: 5.001 (Fan Stage (0..255))

107	Fan Speed Enumerated Feedback	0-Auto;1-Speed1;...6-Turbo	1 byte	CRT
-----	-------------------------------	----------------------------	--------	-----

This object is used to receive current fan speed in between 0-5 values.

DPT: 5.001 (Fan Stage (0..255))

108	Fan Speed 1 Control	1-Set Fan Speed 1	1 bit	CW
-----	---------------------	-------------------	-------	----

This object is used to select fan speed 1 individually. If a value 1 is sent, the fan speed will be fan 1.

DPT: 1.002 (Boolean)

109	Fan Speed 1 Feedback	1-Fan Speed 1	1 bit	CRT
-----	----------------------	---------------	-------	-----

This object is used to monitor the fan speed 1 of the air conditioner.

DPT: 1.002 (Boolean)

110	Fan Speed 2 Control	1-Set Fan Speed 2	1 bit	CW
------------	----------------------------	--------------------------	--------------	-----------

This object is used to select fan speed 2 individually. If a value 1 is sent, the fan speed will be fan 2.

DPT: 1.002 (Boolean)

111	Fan Speed 2 Feedback	1-Fan Speed 2	1 bit	CRT
------------	-----------------------------	----------------------	--------------	------------

This object is used to monitor the fan speed 2 of the air conditioner.

DPT: 1.002 (Boolean)

112	Fan Speed 3 Control	1-Set Fan Speed 3	1 bit	CW
------------	----------------------------	--------------------------	--------------	-----------

This object is used to select fan speed 3 individually. If a value 1 is sent, the fan speed will be fan 3.

DPT: 1.002 (Boolean)

113	Fan Speed 3 Feedback	1-Fan Speed 3	1 bit	CRT
------------	-----------------------------	----------------------	--------------	------------

This object is used to monitor the fan speed 3 of the air conditioner.

DPT: 1.002 (Boolean)

114	Fan Speed 4 Control	1-Set Fan Speed 4	1 bit	CW
------------	----------------------------	--------------------------	--------------	-----------

This object is used to select fan speed 4 individually. If a value 1 is sent, the fan speed will be fan 4.

DPT: 1.002 (Boolean)

115	Fan Speed 4 Feedback	1-Fan Speed 4	1 bit	CRT
------------	-----------------------------	----------------------	--------------	------------

This object is used to monitor the fan speed 4 of the air conditioner.

DPT: 1.002 (Boolean)

116	Fan Speed 5 Control	1-Set Fan Speed 5	1 bit	CW
------------	----------------------------	--------------------------	--------------	-----------

This object is used to select fan speed 5 individually. If a value 1 is sent, the fan speed will be fan 5.

DPT: 1.002 (Boolean)

117	Fan Speed 5 Feedback	1-Fan Speed 5	1 bit	CRT
------------	-----------------------------	----------------------	--------------	------------

This object is used to monitor the fan speed 5 of the air conditioner.

DPT: 1.002 (Boolean)

118	Fan Speed Turbo Control	1-Set Fan Speed Turbo	1 bit	CW
------------	--------------------------------	------------------------------	--------------	-----------

This object is used to select fan speed 5 individually. If a value 1 is sent, the fan speed will be fan 5.

DPT: 1.002 (Boolean)

119	Fan Speed Turbo Feedback	1-Fan Speed Turbo	1 bit	CRT
------------	---------------------------------	--------------------------	--------------	------------

This object is used to monitor the fan speed 5 of the air conditioner.

DPT: 1.002 (Boolean)

120	Fan Speed Auto Control	1-Set Fan Speed Auto	1 bit	CW
------------	-------------------------------	-----------------------------	--------------	-----------

This object is used to select fan speed Auto individually. If a value 1 is sent, the fan speed will be fan Auto. After this object is disabled, means value 0 is sent, fan speed returns the state before auto fan speed set.

DPT: 1.002 (Boolean)

121	Fan Speed Auto Feedback	1-Set Fan Speed Auto	1 bit	CRT
------------	--------------------------------	-----------------------------	--------------	------------

This object is used to monitor the fan speed Auto of the air conditioner.

DPT: 1.002 (Boolean)

122	Fan Speed +/-	0-Decrease;1-Increase	1 bit	CW
------------	----------------------	------------------------------	--------------	-----------

This object is used to change between fan speed levels with a 1-bit value. If a continuous value is sent in the increasing direction, it follows the following sequence. Additionally, if the “Loop the sequence” parameter is activated, increasing or decreasing that returns the mode to the beginning when it reaches the last mode.

1:Increase : auto->fan speed 1->fan speed 2->fan speed 3-> fan speed 4->fan speed 5

0:Decrease : fan speed 5-> fan speed 4->Fan speed 3->fan speed 2->fan speed 1->auto

DPT: 1.007 (Step)

122	Fan Speed +/-	0-Up;1-Down	1 bit	CW
------------	----------------------	--------------------	--------------	-----------

This object is used to change between fan speed levels with a 1-bit value. If a continuous value is sent in the increasing direction, it follows the following sequence. Additionally, if the “Loop the sequence” parameter is activated, increasing or decreasing that returns the mode to the beginning when it reaches the last mode.

0:Up: auto->fan speed 1->fan speed 2->fan speed 3-> fan speed 4->fan speed 5

1:Down: fan speed 5-> fan speed 4->Fan speed 3->fan speed 2->fan speed 1 ->auto

DPT: 1.008 (Up / Down)

123	Fan Speed Text Feedback	Fan Speed Text	14 bytes	CRT
------------	--------------------------------	-----------------------	-----------------	------------

This object is used to receive the air conditioner unit's fan speed status via text format. For each fan speed status up to 14 bytes are allowed to determine the name of the fan speeds.

DPT: 16.001 (Character String (ISO))

4.6. Temperature Group Objects

In this section, temperature group objects and their properties are described.

Object Number	Object Name	Function	Type	Flags
124	Setpoint Temperature Control	Temperature(Celsius)	2 bytes	CW

This object is used to modify the setpoint temperature to be sent to the AC indoor unit according to the desired value.

DPT: 9.001 (Temperature °C)

125	Setpoint Temperature Feedback	Temperature(Celsius)	2 bytes	CRT
-----	-------------------------------	----------------------	---------	-----

This object is used to monitor the air conditioner unit setpoint temperature from the KNX bus line.

DPT: 9.001 (Temperature °C)

126	Setpoint Temperature +/-	0-Decrease;1-Increase	1 bit	CW
-----	--------------------------	-----------------------	-------	----

This object is used to change the setpoint temperature by increasing or decreasing by a 1-bit value. If a continuous value is sent in the increasing direction, it is increased up to the highest temperature value. Likewise, if a continuous value is sent in the decreasing direction, it is decreased up to the lowest temperature value.

DPT: 1.007 (Step)

126	Setpoint Temperature +/-	0-Up;1:Down	1 bit	CW
-----	--------------------------	-------------	-------	----

This object is used to change the setpoint temperature by increasing or decreasing by a 1-bit value. If a continuous value is sent in the increasing direction, it is increased up to the highest temperature value. Likewise, if a continuous value is sent in the decreasing direction, it is decreased up to the lowest temperature value.

DPT: 1.008 (Up/Down)

127	Ambient Temperature	Temperature (Celsius)	2 bytes	CW
-----	---------------------	-----------------------	---------	----

This object is used to receive the KNX ambient temperature from the KNX bus line. This option only works when the Gateway operates in master mode.

DPT: 9.001 (Temperature °C)

128	Ambient Temperature Feedback	Temperature (Celsius)	2 bytes	CRT
-----	------------------------------	-----------------------	---------	-----

This object is used to read the ambient temperature that sended to air conditioner or readed from the air conditioner.

- When “Enable ambient temperature” parameter is selected “No” and “Ambient temperature feedback send state” is different from “Disable”, this object shows the ambient temperature readed from air conditioner indoor temperature sensor.
- When “Enable ambient temperature” parameter is selected “Yes”, this object shows the ambient temperature sended to air conditioner. If there is no ambient temperature coming from KNX bus through 5 mins, the device select ambient temperature reference as “AC indoor sensor temp” until ambient temperature value sends over KNX again. Temperature value readed from indoor unit can be observed in KNX bus.

DPT: 9.001 (Temperature °C)

4.7. Air Deflectors Group Objects

In this section, air deflector group objects and their properties are described.

Object Number	Object Name	Function	Type	Flags
129	Air Deflector Broadcast Value	0-Swing;1-Pos1;...5-Pos5	1 byte	CW

This object is used to receive the current air deflector position in between 0-5 values.

DPT: non DPT

130	Air Deflector +/-	0-Decrease ;1-Increase	1 bit	CW
-----	-------------------	------------------------	-------	----

This object is used to change between air deflector position levels with a 1-bit value. If a continuous value is sent in the increasing direction, it follows the following sequence. Additionally, if the “Loop the sequence” parameter is activated, increasing or decreasing that returns the mode to the beginning when it reaches the last mode.

1:Increase : Swing ->pos 1->pos 2->pos 3->pos 4->pos 5

0:Decrease : pos 5->pos 4->pos 3->pos 2->pos 1->Swing

DPT: 1.007 (Step)

130	Air Deflector +/-	0-Up;1-Down	1 bit	CW
-----	-------------------	-------------	-------	----

This object is used to change between air deflector position levels with a 1-bit value. If a continuous value is sent in the increasing direction, it follows the following sequence. Additionally, if the “Loop the sequence” parameter is activated, increasing or decreasing that returns the mode to the beginning when it reaches the last mode.

0:Up : Swing->pos 1->pos 2->pos 3->pos 4->pos 5

1:Down : pos 5->pos 4->pos 3->pos 2->pos 1->Swing

DPT: 1.008 (Up/Down)

131	Air Deflector Feedback	0-Swing;1-Pos1;...5-Pos5	1 byte	CRT
-----	------------------------	--------------------------	--------	-----

This object is used to receive the air conditioner unit's air deflector position status via 1 byte object.

DPT: non DPT

4.8. Scene Group Objects

In this section, scene group objects and their properties are described.

Object Number	Object Name	Function	Type	Flags
145	Scene	1-63(Execute 1-64);128-191 (Storage 1-64)	1 byte	CRWTU

This object is used to execute or store a scenario with a specified scenario number. According to the KNX scenario numbers could be between 1-64. If a scenario wanted to be stored, the scenario number + 128 value must be sent. Also, this object is always visible.

DPT: 18.001 (Scene Control)

146, 148, 150 152, 154	Scene 1...5 Run	0-Nothing;1-Run Scene	1 bit	CWT
---------------------------	-----------------	-----------------------	-------	-----

This object is used to run the associated scenario number 1 to 5. These scenario numbers are listed on the scene parameter page.

DPT: 1.002 (Boolean)

147, 149, 151, 153, 155	Scene 1...5 Storage	0-Nothing;1-Storage Scene	1 bit	CWT
----------------------------	------------------------	---------------------------	-------	-----

This object is used to record the current status of the air conditioner unit to the desired scenario from 1 to 5. The desired scenario number (e.g., 68) can be assigned to these scenes.

DPT: 1.002 (Boolean)

156	Current Scene Feedback	1-64:Current Scene	1 byte	CRT
-----	---------------------------	--------------------	--------	-----

This object is used to view the current scene of the air conditioner unit. Scene values can be monitored from the KNX bus line. According to KNX standards scene values should be between 1-64.

DPT: 17.001 (Scene Number)

4.9. Special Group Objects

In this section, special functions group objects and their properties are described.

Object Number	Object Name	Function	Type	Flags
161	Working Hour Counter Feedback	Working Hours Counter Feedback	5 bytes	CRT

This object is used to detect the air conditioner's operating hours in working mode. When the air conditioner starts to work, the working hours counter starts to count the value.

DPT: 13.100 (Time Lag (s))

162	Working Hour Alert Feedback	0-No Alarm;1-Alarm	1 bit	CRT
-----	-----------------------------	--------------------	-------	-----

This object is used to view the air conditioner unit's alert status when the specified working hours operation period ends. Counter creates an alert to warn the user.

DPT: 1.005 (Alarm)

163	Reset Hours Counter	0-No Action;1-Reset	1 bit	CW
-----	---------------------	---------------------	-------	----

This object is used to reset the counted hours by the working hours counter function. If a value 1 is sent via this object, the working hours counter will be reset.

DPT: 1.015 (Reset)

132	Window Contact Status	0-Opened;1-Closed 0-Closed;1-Opened	1 bit	CRWT
-----	-----------------------	----------------------------------------	-------	------

This object is used to receive the status of the window contact. It can be configured which value to which it means from the parameter page.

DPT:

1.009 (Open/Close)

1.019 (Window/Door)

133	Window Switch-Off Delay	Values are accepted according to the data type of 20.013.	1 byte	CW
------------	--------------------------------	------------------------------------------------------------------	---------------	-----------

This object is used to switch off the air condition unit according to delay time by a 1-byte value.

DPT: 20.013 (Time Delay)

134, 138	Standby X Function	0-Not Occupied;1-Occupied 0-Stop;1-Start	1 bit	CW
-----------------	---------------------------	-----------------------------------------------------	--------------	-----------

This object is used to control the standby function of the air conditioner unit. The object also can be parameterized as start/stop or occupied/not occupied.

DPT:

1.018 (Occupancy)

1.010 (Start/Stop)

135, 139	Standby X Feedback	0-Not Occupied;1-Occupied 0-Stop;1-Start	1 bit	CRT
-----------------	---------------------------	-----------------------------------------------------	--------------	------------

This object is used to view the air condition unit's standby function status.

DPT:

1.018 (Occupancy)

1.010 (Start/Stop)

136, 140	Standby X Delay	Values are accepted according to the data type of 20.013.	1 byte	CW
-----------------	------------------------	------------------------------------------------------------------	---------------	-----------

This object is used to set the delay time of the air conditioner unit's standby function.

DPT: 20.013 (Time Delay)

137, 141	Standby X Setpoint Shifting	Temperature (Celsius)	2 bytes	CWT
-----------------	------------------------------------	------------------------------	----------------	------------

This object is used to set the setpoint shifting of the air conditioner unit's standby function.

DPT: 9.001 (Temperature (°C))

142	Timer Function	0-Stop;1:Start 0-Start;1:Stop	1 bit	CW
------------	-----------------------	------------------------------------------	--------------	-----------

This object is used to control the timer function of the air conditioner unit. The start and stop operations can be determined with which value will be used. Value 1 can be start function or stop according to settings. The air conditioner will stop after time is ended.

DPT: 1.010 (start/stop)

143	Feedback Timer Function	0-Stop;1:Start 0-Start;1:Stop	1 bit	CRT
------------	--------------------------------	------------------------------------------	--------------	------------

This object is used to view the timer function status of the air conditioner unit.

DPT: 1.010 (start/stop)

144	Timer Duration	Values are accepted according to the data type of 20.013	1 byte	CW
------------	-----------------------	-------------------------------------------------------------------------	---------------	-----------

This object is used to specify the time duration of the timer function.

DPT: 20.013 (Time Delay)

4.10. Digital Input Objects

This section describes the "Digital Input" group objects and their properties. This is a fully compatible KNX device that must be configured and set up using the standard KNX tool ETS. Up to 3 different digital input can be selected. Each digital input can be set independently.

X: 1...3

Object Number	Object Name	Function	Type	Flags
164, 167, 170	Input X	Block	1 bit	CW

This object is used to block digital input functionality.

DPT: 1.003 (enable)

165, 168, 171	Input X	Switch	1 bit	CRWT
---------------	---------	--------	-------	------

This object is used to set or reset digital input functionality in short time.

DPT: 1.001 (switch)

166, 169, 172	Input X	Switch Long	1 bit	CRWT
---------------	---------	-------------	-------	------

This object is used to set or reset digital input functionality in determined long time.

DPT: 1.001 (switch)

Appendix

Error Code Remote Controller Display (ASCII)	Error Code Hex	Error Definition
0	0	No Error
E0	4530	Outdoor Unit Error
E1	4531	High Pressure Protection
E2	4532	Discharge Low Temperature Protection
E3	4533	Low Pressure Protection
E4	4534	Excess Discharge Temperature Protection of Compressor
F0	4630	Bad Performance of the Outdoor Mainboard
F1	4631	High Pressure Sensor Error
F6	4636	Compressor 2 Discharge Temperature Sensor Error
F7	4637	Compressor 3 Discharge Temperature Sensor Error
F8	4638	Compressor 4 Discharge Temperature Sensor Error
F9	4639	Compressor 5 Discharge Temperature Sensor Error
FA	463A	Compressor 6 Discharge Temperature Sensor Error
Fb	4662	Compressor 2 Top Temperature Sensor Error
FC	4643	Compressor 2 Current Sensor Error
Fd	4664	Mode Exchanger Outlet Pipe Temperature Sensor Error
FE	4645	Compressor 4 Current Sensor Error
FF	4646	Compressor 5 Current Sensor Error
FH	4648	Compressor 1 Current Sensor Error
FJ	464A	Compressor 6 Current Sensor Error
FL	464C	Compressor 3 Current Sensor Error
Fn	466E	Mode Exchanger Inlet Pipe Temperature Sensor Error
FP	4650	Malfunction of DC motor
FU	4655	Compressor 2 Top Temperature Sensor Error
J1	4A31	Compressor 1 Over-current Protection

J2	4A32	Compressor 2 Over-current Protection
J3	4A33	Compressor 3 Over-current Protection
J4	4A34	Compressor 4 Over-current Protection
J5	4A35	Compressor 5 Over-current Protection
J6	4A36	Compressor 6 Over-current Protection
J7	4A37	4-way Valve Blow-by Protection
J8	4A38	System Pressure Over-Ratio Protection
J9	4A39	System Pressure Under-Ratio Protection
JA	4A41	Protection of Abnormal Pressure
JC	4A43	Protection of Water Flow Switch
JE	4A45	Oil return pipe is blocked
JF	4A46	Oil return pipe is leaking
JL	4A4C	Protection of Low High-pressure
b1	6231	Outdoor Ambient Temperature Sensor Error
b2	6232	Defrosting Temperature Sensor 1 Error
b3	6233	Defrosting Temperature Sensor 2 Error
b4	6234	Subcooler Liquid-out Temperature Sensor Error
b5	6235	Subcooler Gas-out Temperature Sensor Error
b6	6236	Gas-liquid separator inlet temperature sensor error
b7	6237	Gas-liquid separator outlet temperature sensor error
b8	6238	Outdoor Humidity Sensor Error
b9	6239	Heat Exchanger Gas-out Temperature Sensor Error
bA	6241	Oil-return Temperature Sensor Error
bC	6243	Compressor 1 Top Temperature Sensor Detachment Protection
bE	6245	Malfunction of entry tube temperature sensor of condenser
bF	6246	Malfunction of exit tube temperature sensor of condenser
bH	6248	System Clock Malfunction
bJ	624A	High and low pressure sensors are connected inversely
bL	624C	Compressor 2 Top Temperature Sensor Detachment Protection

P0	5030	Compressor Drive Board Error
P1	5031	Compressor Drive Board Malfunction
P2	5032	Protection of Compressor Drive Board Power Supply
P3	5033	Protection of Compressor Drive Board Module Reset
H0	4830	Error of Fan Drive Board
H1	4831	Malfunction of Fan Drive Board
H2	4832	Protection of Fan Drive Board Power Supply
L0	4C30	Indoor Unit Error
L1	4C31	Indoor Fan Protection
L2	4C32	E-heater Protection
L3	4C33	Water Full Protection
L4	4C34	Wired Controller Power Supply Error
L5	4C35	Anti-Frosting Protection
L7	4C37	No Master Indoor Unit Error
L8	4C38	Power Insufficiency Protection
L9	4C39	Quantity Of Group Control Indoor Units Setting Error
LA	4C41	Indoor Units Incompatibility Error
Lb	4C62	Inconsistency of Group-controlled Indoor Units in Reheat Dehumidification System
LC	4C43	Outdoor-Indoor Incompatibility Error
LF	4C46	Shunt Valve Setting Error
LH	4C48	Low Air Quality Warning
LJ	4C4A	Wrong Setting of Function DIP Switch
LP	4C50	Zero-crossing malfunction of PG motor
LU	4C55	Inconsistent Branch of Group-controlled Indoor Units in Heat Recovery System
d1	6431	Indoor Unit PC-Board Error
d3	6433	Ambient Temperature Sensor Error
d4	6434	Inlet Pipe Temperature Sensor Error
d5	6435	Malfunction of middle tube temperature sensor
d6	6436	Outlet Pipe Temperature Sensor Error
d7	6437	Humidity Sensor Error

d8	6438	Water Temperature Abnormality
d9	6439	Jumper Cap Error
dA	6441	Indoor Unit Hardware Address Error
db	6462	Special Code: Field Debugging Code
dC	6443	Capacity DIP Switch Setting Error.
dE	6445	Indoor Unit CO2 Sensor Error
dH	6448	Wired Controller PC-Board Error
dL	644C	Outlet Air Temperature Sensor Error
dn	646E	Swing Assembly Error
y7	7937	Fresh Air Inflow Temperature Sensor Error
y8	7938	Indoor Air Box Sensor Error
y9	7939	Outdoor Air Box Sensor Error
U2	5532	Outdoor Unit Capacity Code/Jumper Cap Setting Error
U3	5533	Phase Sequence Protection of Power Supply
U4	5534	Protection of Lack of Refrigerant
U5	5535	Wrong Address of Compressor Drive Board
U6	5536	Valve Abnormal Alarm
U8	5538	Indoor Unit Tube Malfunction
U9	5539	Outdoor Unit Tube Malfunction
UC	5543	Master indoor unit is successfully set.
UE	5545	Refrigerant Charging is ineffective
UF	5546	Indoor Unit Identification Error of Mode Exchanger
UL	554C	Emergency Operation DIP switch setting of the compressor is wrong.
C0	4330	Communication between indoor unit and outdoor unit and the communication between indoor unit and wired controller have malfunction.
C2	4332	Communication error between master control and inverter compressor drive
C3	4333	Communication error between master control and inverter fan motor drive
C4	4334	Error of Lack of Indoor Unit
C5	4335	Alarm of Indoor Unit Project Number Collision
C6	4336	Alarm of Wrong Number of Outdoor Unit

C7	4337	Mode Exchanger Communication Error
Cb	4362	Outflow of Units IP Address
Cd	4364	Communication Failure Between Mode Exchanger and Outdoor Unit
CE	4345	Communication Failure Between Mode Exchanger and Indoor Unit
CF	4346	Error of Multiple Master Indoor Unit
CH	4348	Rated capacity is too high.
CJ	434A	System addresses is incompatible.
CL	434C	Rated capacity is too low.
Cn	436E	Indoor and Outdoor Network Error of Mode Exchanger
CP	4350	Error of Multiple Master Wired Controller
CU	4355	Communication Error between Indoor Unit and Remote Receiver
Cy	4379	Communication Error of No Master in Mode Exchanger
??	3F3F	Unknown Error
	1000	Ac Communication Error
	1001	Ac Error Transmit
	1002	Ac Error Receive
	1005	Ac Error No Ambient Temp Receiving from KNX Bus.

Special Notes



If you encounter an error code not listed in this table, please contact your nearest Vaillant technical service.

Errata

Error	Error Definition	ETS Version
Standby 2 Setpoint shifting no group object	"Enable standby function" parameter "Occupied-1;Not Occupied-0" in Standby 2 is selected. When "Via Communication Object" is selected for "Setpoint temperature shifting state" parameter in Standby 2, the related group object is not created.	v1.0

CONTACT INFORMATION

THE INTERRA WEBSITE

Interra provides documentation support via our website www.interratechnology.com. This website is used as a means to make files and information easily available to customers. Accessible by using your favourite Internet browser, the website contains the following information:

- Information about our products and projects.
- Overview of Interra company and values.
- Product Support: Datasheets, product manuals, application descriptions, latest software releases, ETS databases and archived software.

EUROPE, Türkiye

Interra Technology
Cumhuriyet mah. Kartal cad. Interra R&D Center
No:95/1 Kartal/İstanbul
Tel: +90 (216) 326 26 40 Fax: +90 (216) 324 25 03
Web adress: <http://www.interratechnology.com>