

'INTERRA

Developer of Uniqueness

Indoor Panel Unit with Linux OS Product Manual



CONTENTS

1. Content Of The Document.....	5
2. Product Description	6
2.1. Technical Information.....	7
2.2. Connection Diagram & Features.....	8
2.3. Troubleshooting.....	11
2.4. Safety Instructions	12
3. Homepage	15
3.1. Menu Bar	15
3.2. Status Bar.....	16
3.3. Security.....	17
3.3.1. ON/OFF.....	18
3.3.2. Camera	19
3.3.2.1. IP Camera Setting	19
3.3.3. Zone.....	20
3.3.3.1. Alarm Type	21
3.3.3.2. Mode	21
3.3.3.3. Delay Time	22
3.3.3.4. Sensor Type	22
3.3.4. Scene	23
3.3.5. Setup	24
3.4. Intercom	25
3.4.1. Call Out.....	25
3.4.1.1. Contacts.....	26
3.4.1.2. Call Unit Resident	26
3.4.1.3. Call Management Center	26
3.4.2. Monitor	27
3.4.3. Records.....	27
3.5. Message.....	28
3.6. Setup.....	29
3.6.1. Normal.....	29
3.6.2. Room	29
3.6.3. Network.....	30
3.6.4. Password	31
3.6.5. Version	31

Information contained in this publication regarding device applications and the like is provided only for your convenience and may be superseded versions by updates. It is your responsibility to ensure that your application meets your specifications.

INTERRA MAKES NO REPRESENTATIONS OR WARRANTIES OF ANY KIND WHETHER EXPRESS OR IMPLIED, WRITTEN OR ORAL, STATUTORY OR NONSTATUTORY, RELATED TO THE INFORMATION INCLUDING BUT NOT LIMITED TO ITS CONDITION, QUALITY, PERFORMANCE, MERCHANTABILITY OR FITNESS FOR PURPOSE.

Interra disclaims all liability arising from this information and its use. Use of Interra devices in life support and/or safety applications is entirely at the buyer's risk, and the buyer agrees to defend, indemnify and hold harmless Interra from any damages, claims, suits, or expenses resulting from such use. No licences are conveyed, implicitly or otherwise, under any Interra intellectual rights.

Trademarks

The Interra name, logo and the Interra ITR660-0001 & ITR662-0001 Indoor Intercom Panel with Linux OS device are registered trademarks of Interra Technology in Türkiye and other countries.

All other trademarks mentioned herein are property of Interra Technology.

© 2025, Interra, Printed in Türkiye, All Rights Reserved.



Printed on recycled paper.

TS EN ISO 9001:2008

TO OUR CUSTOMERS

One of our most important aims is to provide you with the best documentation possible to use successfully your Interra products. Focusing on this, we will keep on improving our documentation to better suit your needs. Our publications will be updated as new volumes as soon as changes are introduced.

If you have any questions or comments regarding this publication, do not hesitate to contact us:

E-mail: info@interra.com.tr

Tel: +90 (216) 326 26 40 Fax: +90 (216) 324 25 03

Most Current Product Manual

To obtain the most up-to-date version of this product manual, please visit our Web site at:

<http://www.interratechnology.com>

You can determine the version of an Interra document by examining its literature number found on the bottom right corner of any page.

The first two letters of the literature are the type of document. The numbers that follow are the creation date of the document and the last letter is the version (e.g., PM181017001A is the version A of a product manual created on the date 17/10/18).

1. Content of The Document

This document contains Interra brandmark's ITR660-0001 & ITR662-0001 Indoor Panel Unit with Linux OS coded devices' electronics and all essential features information for programming these products. In each subtitle is explained the characteristics of the devices. Modifications of the product and special change requests are only allowed in coordination with product management.

2. Product Description

ITR660-0001 & ITR662-0001 are Indoor Panel Units with Linux OS panels that are mainly used for making interacting between the related outdoor intercom units. ITR660-0001 & ITR662-0001 product features are described below :

- **Talkback:** Support video call, monitoring, unlocking and checking of call records.
- **Security:** Support 8 alarm zones with three states, zone and scene setup.
- **Smart:** Support smart home extension by RS485 communication (Optional).

ITR660-0001 & ITR662-0001 indoor panel's operating systems are Linux.

2.1. Technical Information

The following table shows the technical information of the ITR660-0001 & ITR662-0001 Indoor Panel Unit with Linux OS.

Product Code	ITR660-0001	ITR662-0001
Power Supply	12 V DC	12 V DC
	POE (48 V DC)	POE (48 V DC)
Rated Power Consumption	9 W	9 W
	12 W (with dual RJ45 Ports)	12 W (with dual RJ45 Ports)
Standby Power Consumption	1.5 W	1.5 W
	3.0 W (with dual RJ45 Ports)	3.0 W (with dual RJ45 Ports)
CPU	1.2 GHz	Arm cortex-A7 1 GHz
RAM	64 MB SD Ram	64 MB SD Ram
Flash	128 MB Flash	16 MB Flash
Display Screen	7" TFT LCD Screen	7" TFT LCD Screen
Touch Screen	Capacitive Touch Screen	Capacitive Touch Screen
Resolution	7" : 800 x 480	7" : 800 x 480
Type of Protection	IP 30	IP 30
Temperature Range	Operation (-5°C...55°C)	Operation (-5°C...55°C)
	Storage (-10°C...70°C)	Storage (-10°C...70°C)
Maximum Air Humidity	< 90 RH	< 90 RH
Colour	White, Black	Black
Dimensions	220 x 166,5 x 21,5 mm (W x H x D)	205 x 129,5 x 18 mm (W x H x D)
Configuration	via Webpage of Indoor Monitor	via Webpage of Indoor Monitor

2.2. Connection Diagram & Features

The following diagram shows how to mount the device on a proper surface. For doing a reliable and accomplished installation, screw-down strength is less than 0.4 Nm. Once the device installation is completed, please check the connection and if needed please re-tighten the screws.

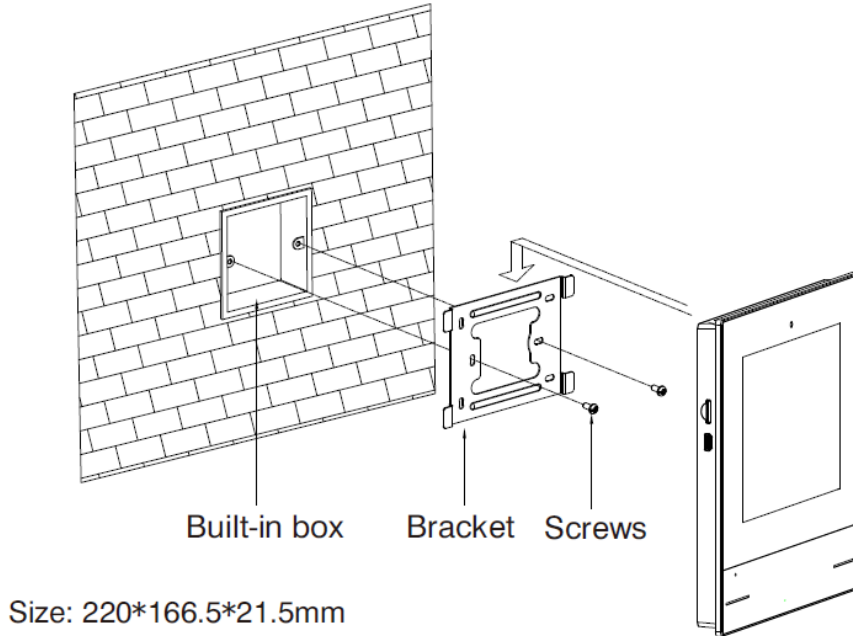

Fig. 1 : Connection Diagram of ITR660-0001 Indoor Panel Unit

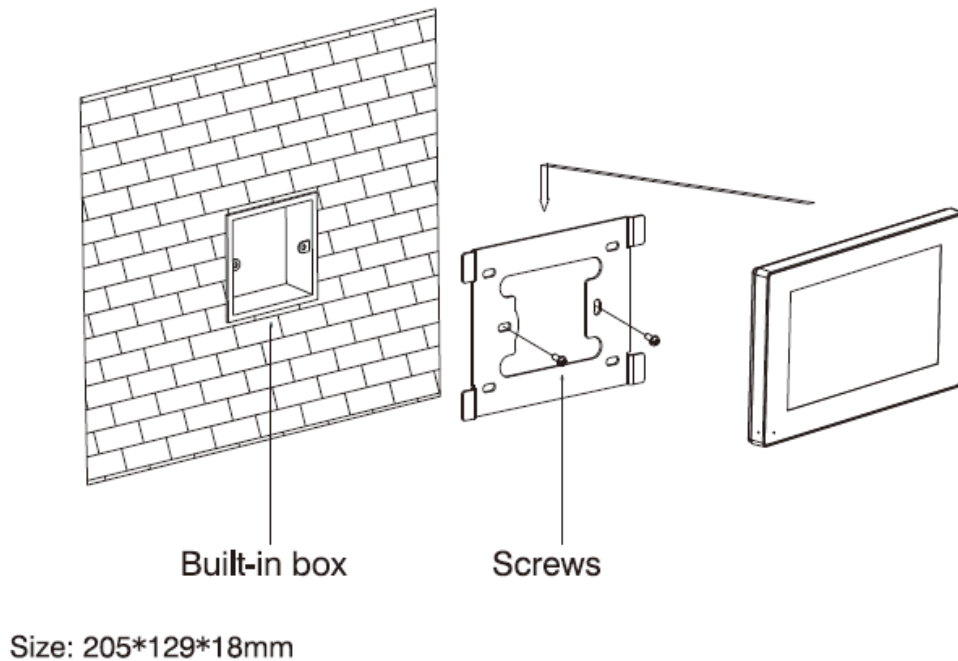

Fig. 2 : Connection Diagram of ITR662-0001 Indoor Panel Unit

The following figure, shows the proper location of the installation :

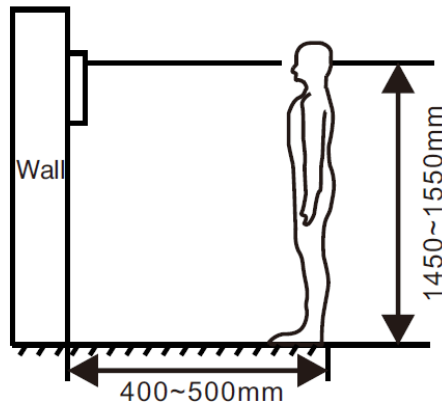

Fig. 3 : A proper location for installation (varies from person to person)

Recommended



During the installation, the camera should be 1450-1550 mm above the ground. The camera tether for photographing the human face should be the top priority.

General :

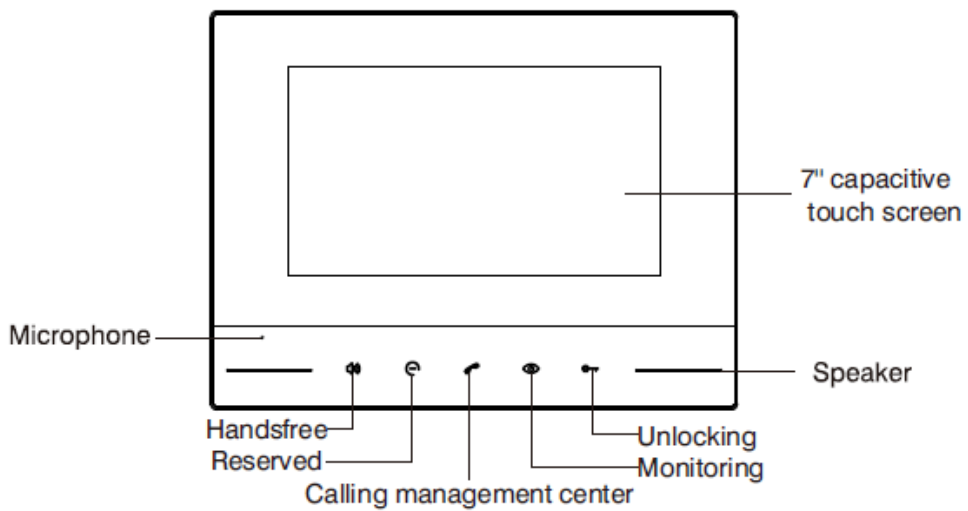

Fig. 4 : ITR660-0001 General Look of the Indoor Monitor

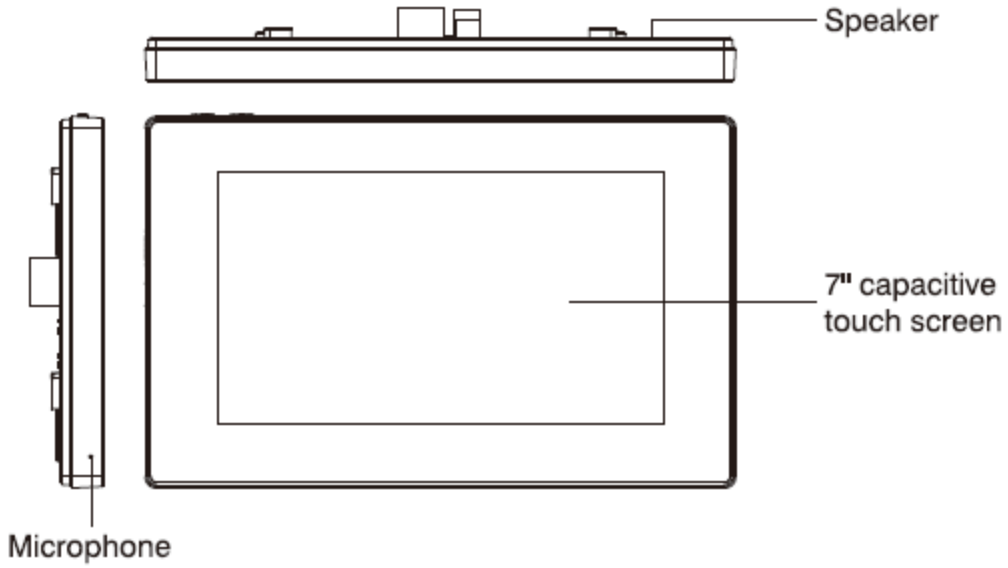

Fig. 5 : ITR662-0001 General Look of the Indoor Monitor

System Diagram:

The following figures show the connectors of the standard version.

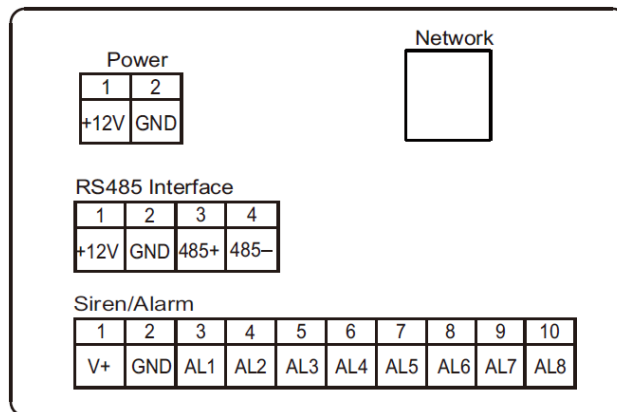

Fig. 6 : Connectors of the standard version

Power:

Power input interface connects with 12 V power adapter. The following figure shows the connection diagram.

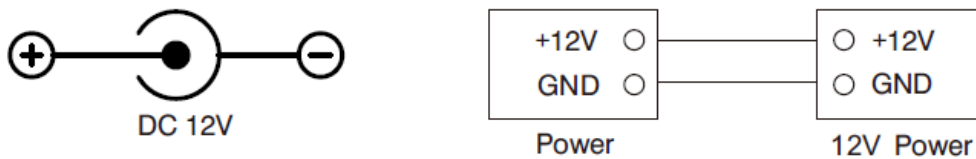

Fig. 7 : Power input connections

Network:

Connect with the outdoor panel, indoor monitor or other network equipment by the network switch. When an indoor monitor has a PoE function, the interface can supply power by connecting with a PoE network switch. If the network interface has a 12 V power supply, pin No. 4 and 5 of RJ45 interface should connect with +12 of power interface, and pin No. 7 and 8 should connect with GND of power interface.

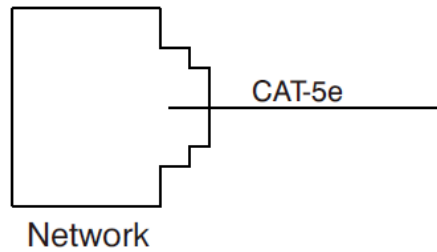

Fig. 8 : Network cable connection

Siren/Alarm:

When the alarm sensor is triggered, the output power is 12 V / 100 mA. Each interface of the alarm zone can be connected with a normally open or normally-closed switch.

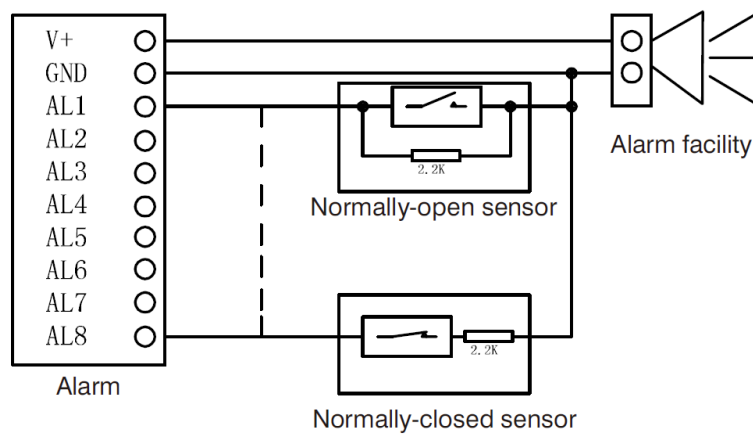

Fig. 9 : Siren/Alarm interface pin connection

2.3. Troubleshooting



The indoor monitor cannot start up or power off automatically.

- Check whether it has a power failure, and power it on again.



The indoor monitor display screen is too dim.

- Check whether the brightness and contrast settings of the screen are correct.



No sound during the communication

- Check whether the indoor monitor is set as mute mode, or the volume is set to the lowest value.



The indoor monitor cannot monitor the outdoor panel.

- Another user is using the system, so you can use it once he/she finished the operation.



Multimedia files cannot be played normally.

- Check whether the system supports the file format. Please refer to the multimedia setting for details.



No response when clicking indoor monitor display screen.

- Press the “Unlock” button for 5s, or slowly slide horizontally or vertically on the LCD to make touchscreen calibration. It needs to be calibrated twice.



Touchscreen responds slowly or cannot make the calibration.

- Take down any protective paster, since it may affect identification and input for the device;
- Ensure the finger is dry and clean when clicking touchscreen
- Restart the device to clear any temporary software error.



The temperature of the device is too high.

- Long-term use leads to high temperature. It is normal and will not affect the device’s useful life and performance.

2.4. Safety Instructions

To protect you and others from harm or your device from damage, please read the following information before using the device.

Do not install the device in the following places:



Do not install the device in a high-temperature and moist environment or the area close to the magnetic field, such as the electric generator, transformer or magnet.



Do not place the device in the sunshine or near the heat source. This might cause discolouration or deformation of the device.



Do not place the device near the heating products such as an electric heater or the fluid container.



Do not install the device in an unstable position to avoid property losses or personal injury caused by the falling of the device.

Guard against electric shock, fire and explosion



Do not use a damaged power cord, plug or loose outlet.



Do not touch the power cord with wet hands or unplug the power cord by pulling.



Do not bend or damage the power cord.



Do not touch the device with wet hands.



Do not make the power supply slip or cause the impact.



Do not use the power supply without the manufacturer's approval.



Do not have the liquids such as water go into the device.

Clean Device Surface



Do not install the device in an unstable position to avoid property losses or personal injury caused by the falling of the device.

Other Tips



To prevent damage to the paint layer or the case, please do not expose the device to chemical products, such as diluent, gasoline, alcohol, insect-resist agents, opacifying agent and insecticide.



Do not knock on the device with hard objects.



Do not press the screen surface. Overexertion might cause flop over or damage to the device.



Please be careful when standing up from under the device.



Do not disassemble, repair or modify the device at your discretion. The arbitrary modification is not covered under warranty. When any repair is required, please contact the customer service centre.



If there is an abnormal sound, smell or fume in the device, please unplug the power cord immediately and contact the customer service centre.



When the device is not used for a long time, the adaptor and memory card can be removed and placed in a dry environment.



When moving, please hand over the manual to new for proper usage of the device.

3. Homepage

The user interface that you can see in the image below is the Indoor Panel homepage. The homepage consists of 2 bars. These are the Menu bar and Status bar. The status bar includes shortcut keys. The detailed expressions are given in the related subtitles.



Fig. 10 : Homepage

NUMBER	PART NO	NAME
1	3.1	Menu Bar
2	3.2	Status

3.1. Menu Bar

The menu bar has the Interra logo on the left and the date and time on the right. You can go to 4 different sections from the menu bar. These sections, from left to right, are Security, Intercom, Message and Setup. These sections will be explained as separate subtitles.

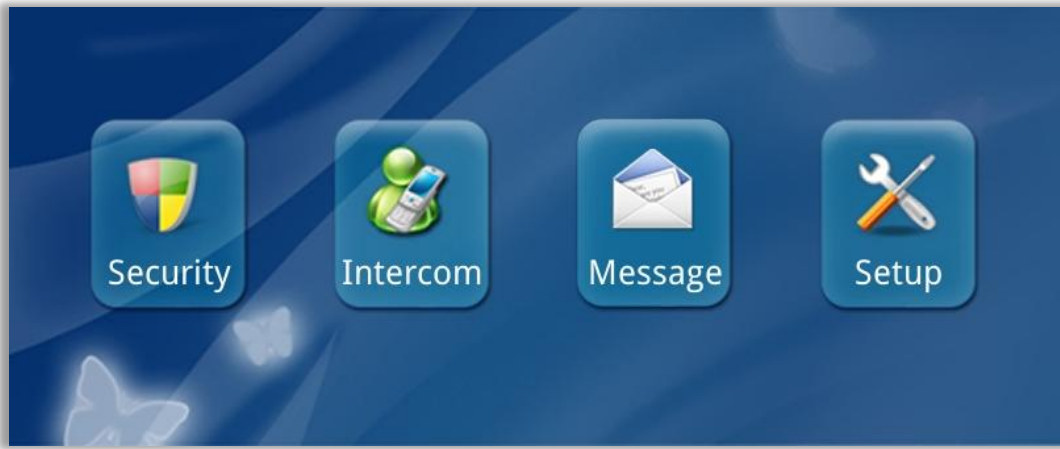

Fig. 11 : Menu Bar

PART NO	NAME
3.3	Security
3.4	Intercom
3.5	Message
3.6	Setup

3.2. Status Bar

The status bar includes notifications and shortcuts keys. The Do Not Disturb shortcut that indicates the panel sound status and can be muted, when necessary, the Message shortcut to reach the Message interface the internet connection part that shows the Internet Connection status, the Security Precautions part that shows if there is a security warning, the SIP Registration parts that show whether there is a Sip call are located in the status bar.

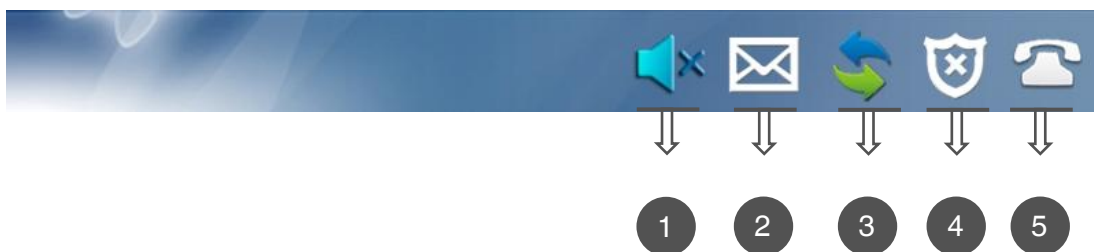









Fig. 12 : Status Bar

NUMBER	SYMBOL	NAME
--------	--------	------

1		Do Not Disturb
2		Message
3		Network Connection
4		Security Precautions
5		SIP Registration Status

1-) **DND** : Click  icon, the system will enter DND or undo DND. You can use the Do Not Disturb service when you do not want to be disturbed by calls(The valid time is 8 hours).

2-) **Message** : Click  it to enter the Message interface.

3-) **Network Connection** :  When this icon keeps lit, the indoor monitor is connected to the network.

4-) **Security Precautions** :  The icon flashes during activation time and keeps lit after arming successfully.

5-) **SIP Registration Status**:  This icon keeps lit when SIP is registered.

3.3. Security

Clicking the “Security” icon on the main interface, the system will enter the following interface. Security



Fig. 13 : Security Interface and its features

3.3.1. ON/OFF

Clicking the “On/Off” icon, the system will enter the following interface:



Fig. 14 : On/Off interface of the Security

On:

Click the “Out”, “Home” or “Sleep” icon to activate the alarm sensors. The corresponding icon on the main interface will be lit up with a “Di-Di” tone and it will stay lit.

Off:

- (1) During the delay time of arming, clicking the “OFF” icon, the system will emit a beep. Then the alarm will be stopped.
- (2) Input user password (the default password is 1234) to stop the alarm under ON status.

3.3.2. Camera

Clicking the “Camera” icon, the system will enter into the following interface:

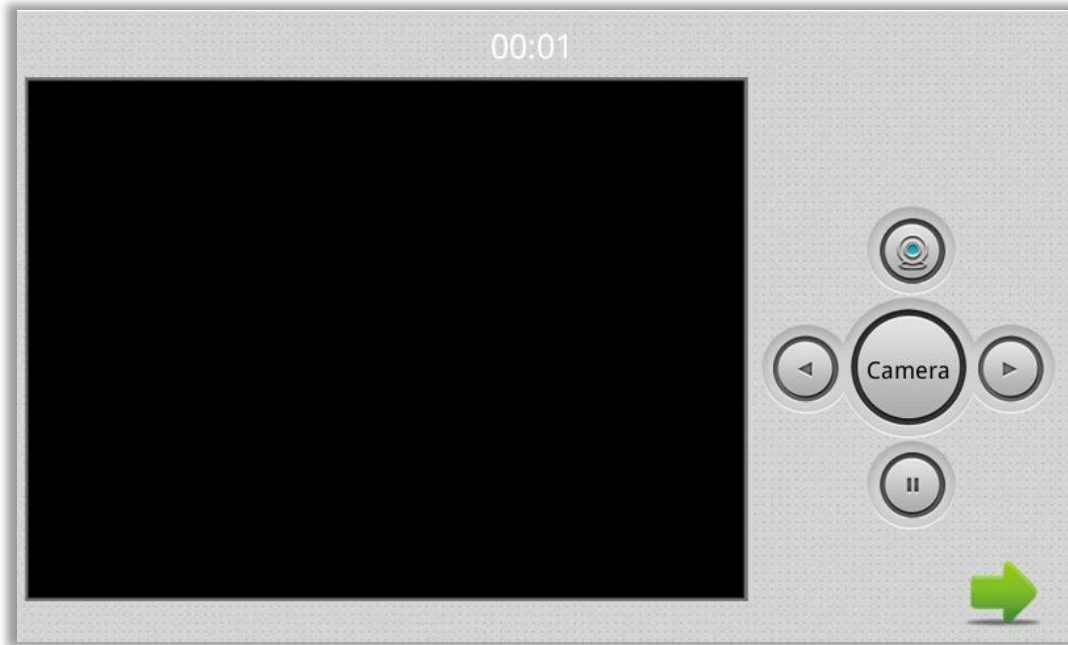





Fig. 15 : On/Off interface of the Security

Click  icon or  icon button to select the camera you want, and then click  to monitor the IP camera. If you want to cancel monitoring, click  to stop it.

3.3.2.1. IP Camera Setting

Login to the webpage of the indoor monitor by :

Username : user

Password : 1234

and then you can access the following webpage :

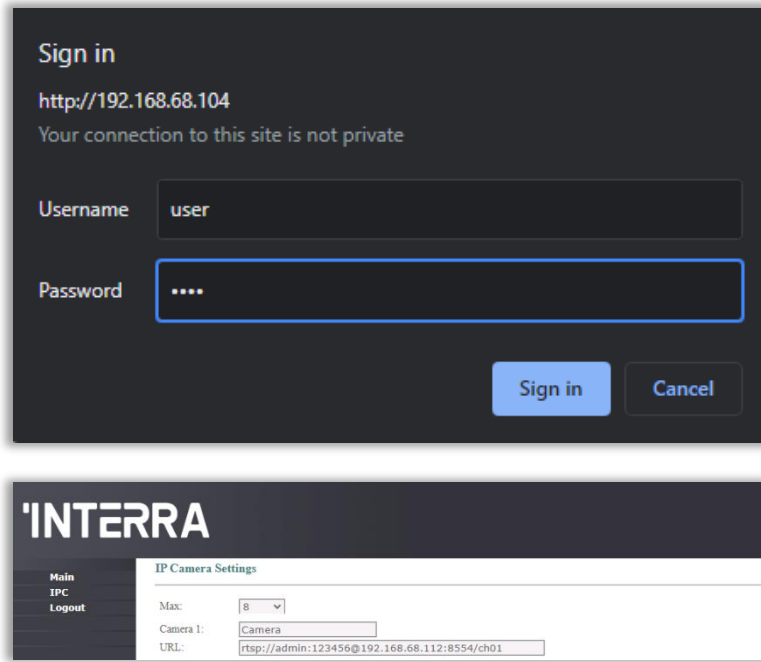

Fig.16 : IP Camera Settings and User Authentication

Fill the RTSP format: rtsp:// user: password @Camera IP. IP is the IP address of your IP Camera. Then you can monitor IP Camera in the Security menu on your indoor monitor.

3.3.3. Zone

Remark: It shall be set when the alarm is OFF.

Click the “Zone” icon and input a 1-16 digits password (the default password is 1234), the system will enter into the following interface:

NO.	Type	Mode	Delay	Sensor
1	24 Hour	NO	0s	Door
2	Normal	NO	0s	Gas
3	Normal	NO	0s	Window
4	Normal	NO	0s	Door
5	Normal	NO	0s	Door
6	Normal	NO	0s	Door
7	Normal	NO	0s	Door
8	Normal	NO	0s	Door

OK ➔

Fig. 17 : Zone interface of the Indoor Monitor

3.3.3.1. Alarm Type

Clicking the input box of type, a dialogue box will pop up as below. On this interface, you can set the alarm type as: Normal, Emergency or 24H. 24H and Emergency types are always active.

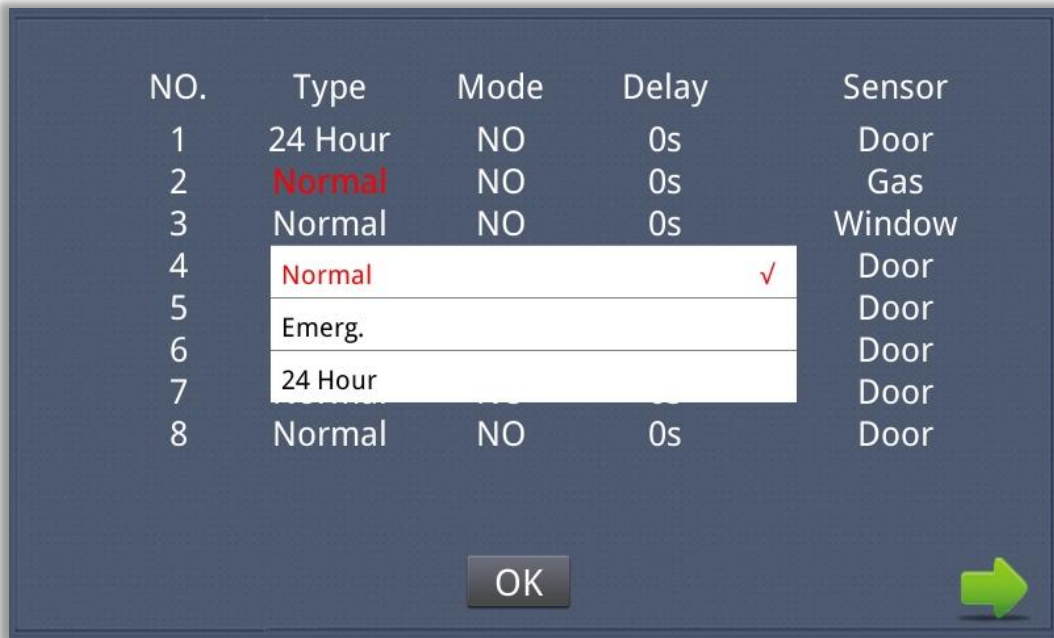

Fig. 18 : Alarm Type page of the zone interface

3.3.3.2. Mode

Clicking the mode setting box will pop up a dialogue box like the following interface. On this interface, you can set the mode as: 3C, NO, NC or BELL.

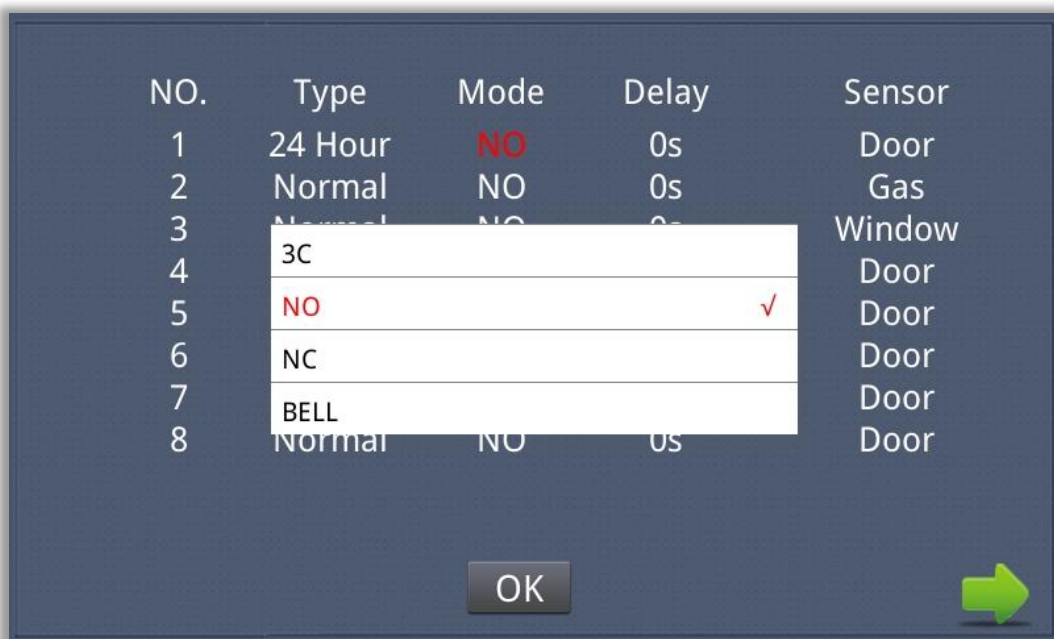

Fig. 19 : Mode page of the zone interface

3.3.3.3. Delay Time

It refers to the delay time of giving an alarm. Clicking the setting box of Delay, it will pop up a dialogue as follows: 0s, 5s, 15s, the 20s, 25s, 40s or 60s. Choose the desired delay time. For example, if you select 5s as the delay time, the indoor monitor will sound alarms in 5 seconds after the alarm sensor is triggered.

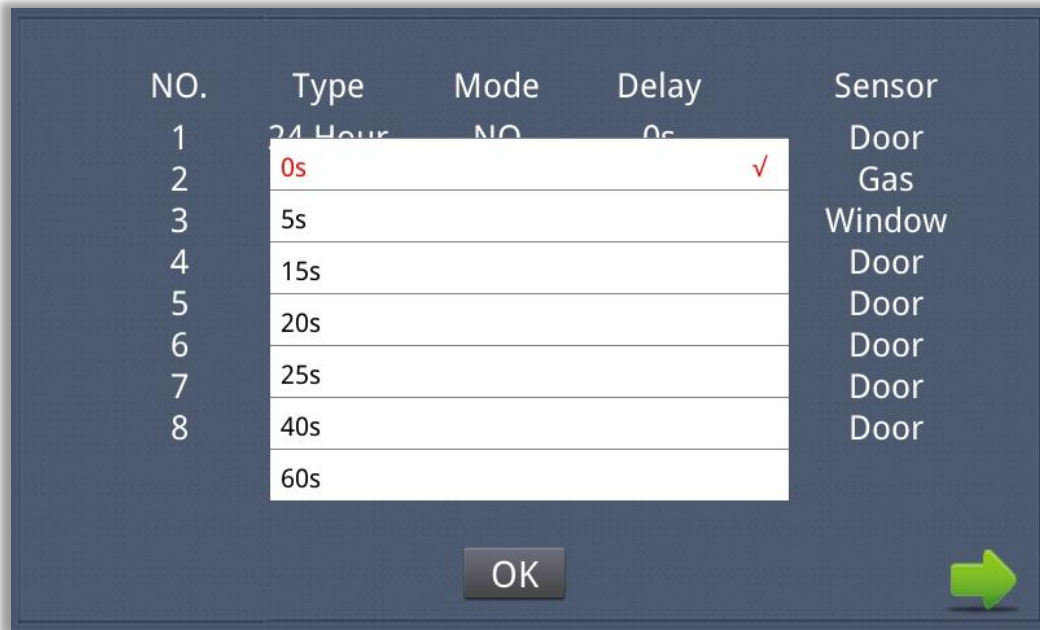

Fig. 20 : Delay time for giving an alarm

3.3.3.4. Sensor Type

Clicking the input box of sensor type will pop up a dialogue box as shown in the following interface. Each sensor type can be set up as: Smoke, Gas, PIR, Door, Window, Panic and Flood.

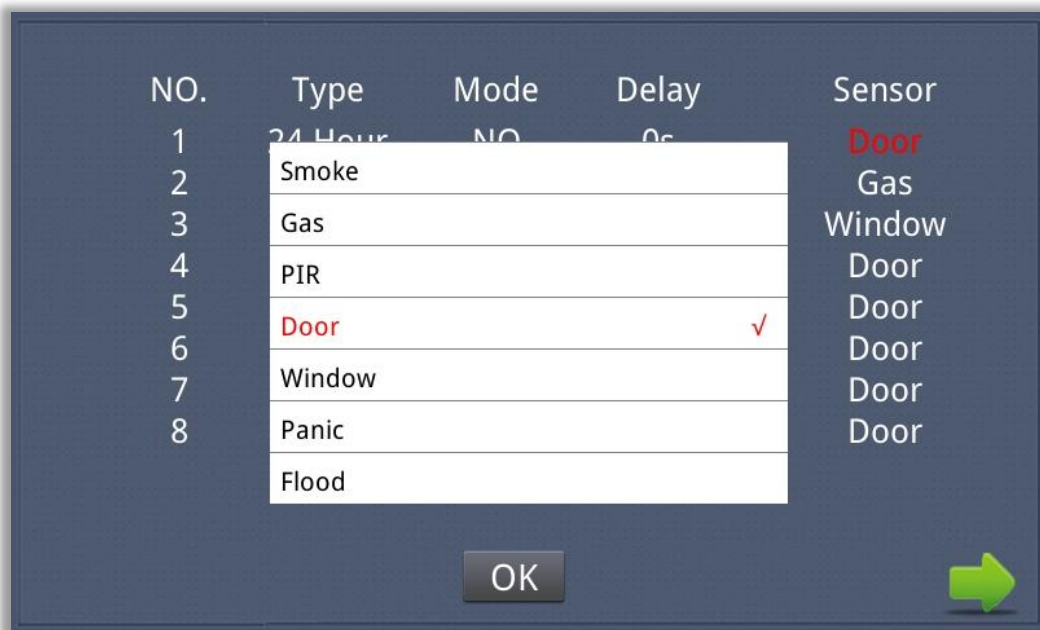

Fig. 21 : Selection of the Sensor Type

When the alarm sensor is triggered, the indoor monitor will make a loud alarm sound, and the system will enter into the following interface as well as send an alarm message to the management centre (if the management centre is installed in your system):



Fig. 22 : Selection of the Sensor Type

You can see the No. and sensor type in the red colour shown at the top of the interface. For example, “2: Smoke” indicates that the smoke sensor in zone 2 is triggered.

To stop the alarm sound, input the password (the default password is 1234).

3.3.4. Scene

Clicking the “Scene” icon, the system will enter into the following interface :

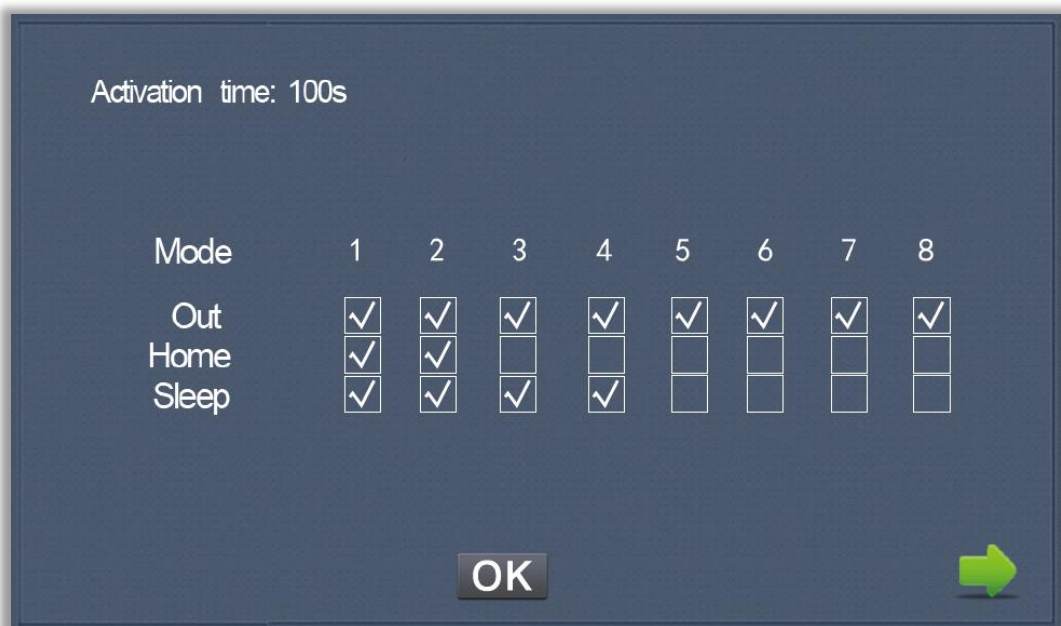

Fig. 23 : Scene interface of the Indoor Panel

This icon refers to Alarm ON, and refers to Alarm OFF. To set the sensor of alarm stations, you can click the corresponding station with icon. Click activation time to choose the corresponding time. The options of activation time include NONE, the 30s, 40s, 60s, 100s and 300s.

3.3.5. Setup

Clicking the “Setup” icon, the system will enter into the following interface:

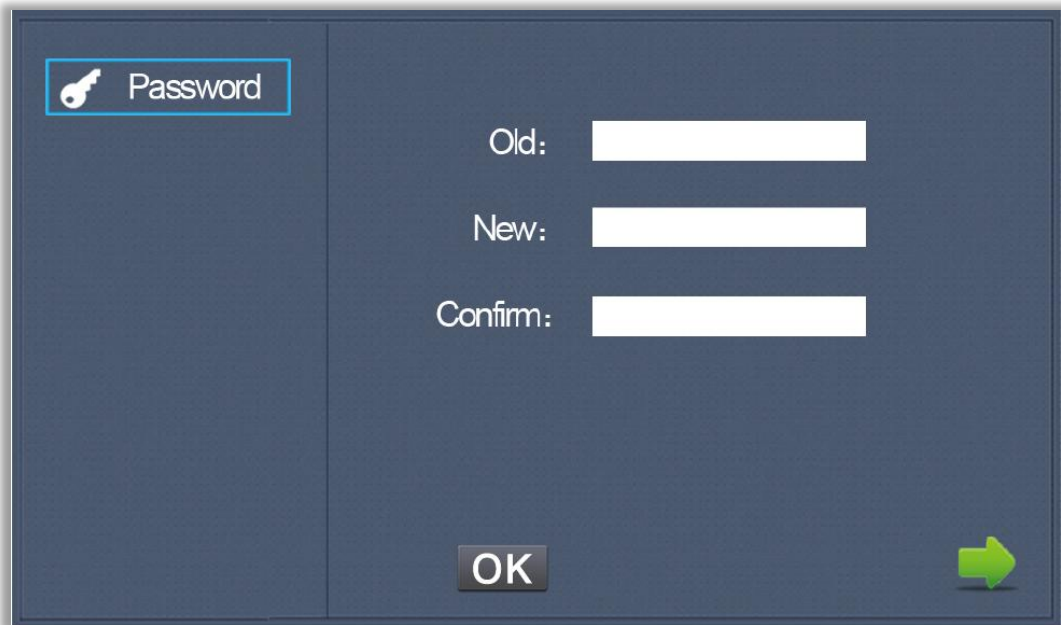

Fig. 24 : Setup interface of the Indoor Panel

You can set the new user password with 1-16 digits (the default password is 1234). User password is used for security.

3.4. Intercom

Clicking the “Intercom” icon on the main interface, the system will enter into the following interface:



Fig. 25 : Intercom interface of the Indoor Panel

3.4.1. Call Out

Clicking the “Call Out” icon, the system will enter the following interface:

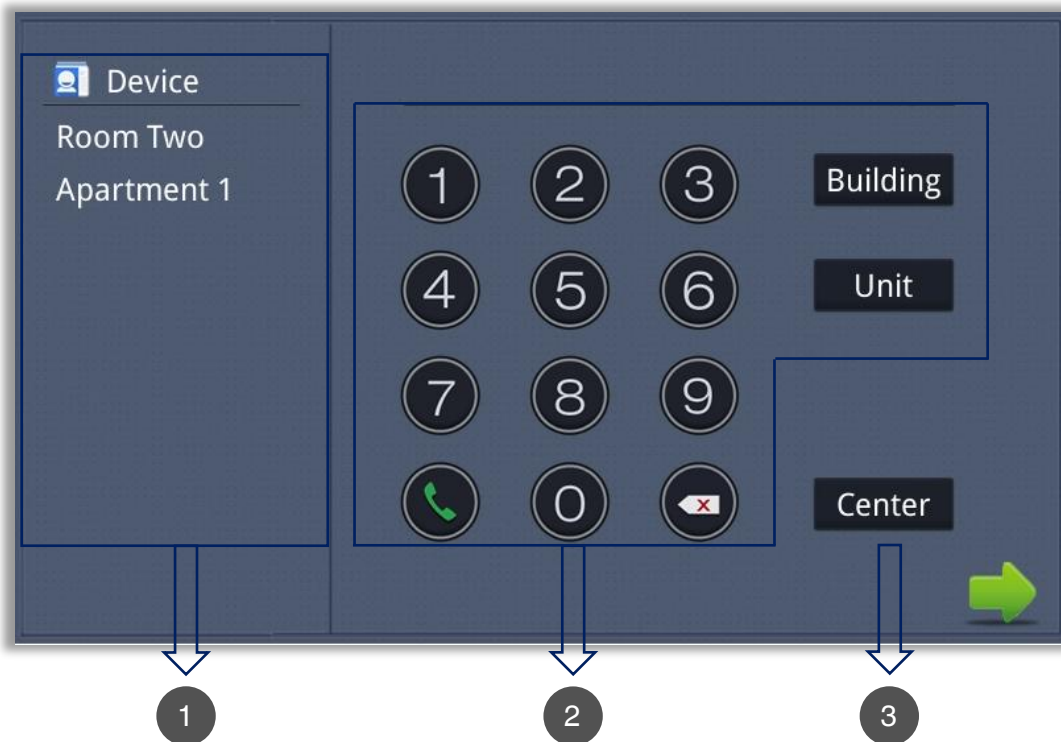



Fig. 26 : Call Out interface of the Indoor Panel

NUMBER	SECTION NO	NAME
1	3.4.1.1	Contact
2	3.4.1.2	Call Unit Resident
3	3.4.1.3	Call Management Center

3.4.1.1. Contacts

Registered persons can be easily called here. The names of the registered persons appear in the list.

3.4.1.2. Call Unit Resident

Used to call for other indoor units in the same system. After entering the Build – Unit – Room format, a calling can be made with the call out button . The system will enter into the following interface:

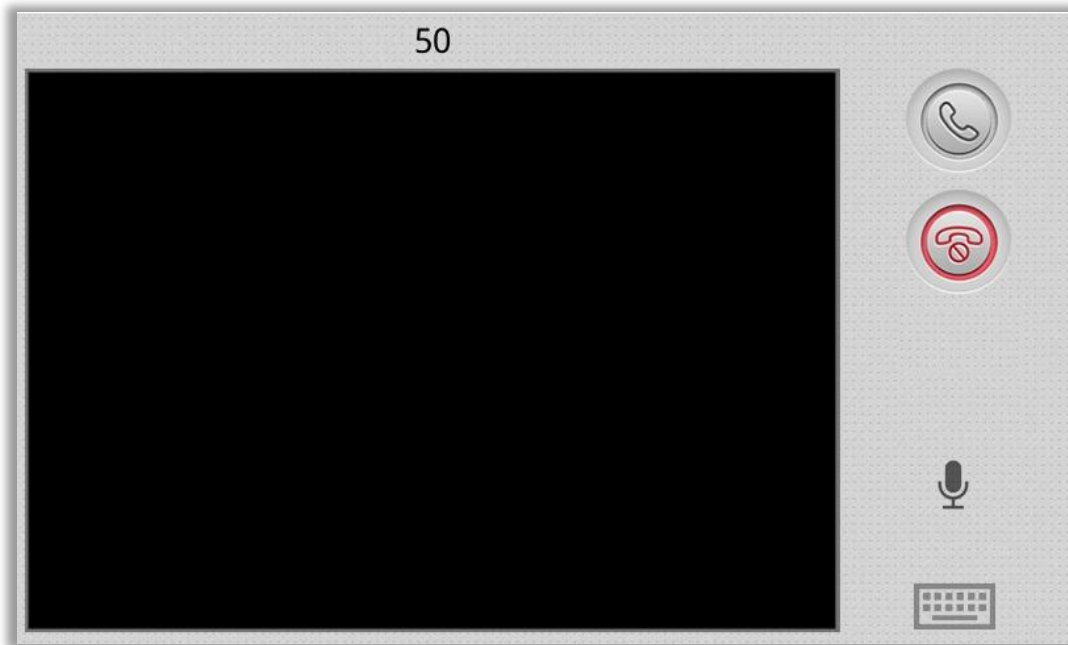



Fig. 27 : Call Out interface of the Indoor Panel

When answering the call, the system will enter into call status:

Click  icon to end the call.

3.4.1.3. Call Management Center

Clicking the “Center” icon to call the management center, the system will call management center 1 to 5 sequentially. If the management center cannot be searched or the call failed, the system will call the next management center. When the management center answers, the indoor monitor will ring and stop calling.

Click  icon to end the communication.

3.4.2. Monitor

Clicking the “Monitor” icon, the system will enter the following interface:



Fig. 28 : Monitor interface of the Indoor Panel

Click the “Door1” icon to switch outdoor panel or flat camera mode, then click icon or icon to select the area you want to monitor, and click icon to monitor the outdoor panel or flat camera. Click icon to stop monitoring. Click icon to unlock the door.

Remark: The system’s default monitoring time is 25s.

3.4.3. Records

Clicking the “Records” icon, the system will enter the following interface:





NO.	Number	Date	Length
1	1010801	00-01-02 14:38:40	3s
2	1029901	14-05-29 08:50:21	11s
3	1029901	14-05-29 08:47:12	8s
4	1029901	14-05-29 08:46:49	13s
5	1019901	14-05-13 13:51:27	11s
6	1019901	00-01-01 09:27:37	35s

Fig. 29 : Records interface of the Indoor Panel

 refers to call-out record

 refers to the call-in record

 refers to the missed call record. It can save up to 64 records.

Click  or  icon to search for records. Select one record and click  icon to call; click  icon to delete it.

If the snapshot is taken, click  icon to view it.

3.5. Message

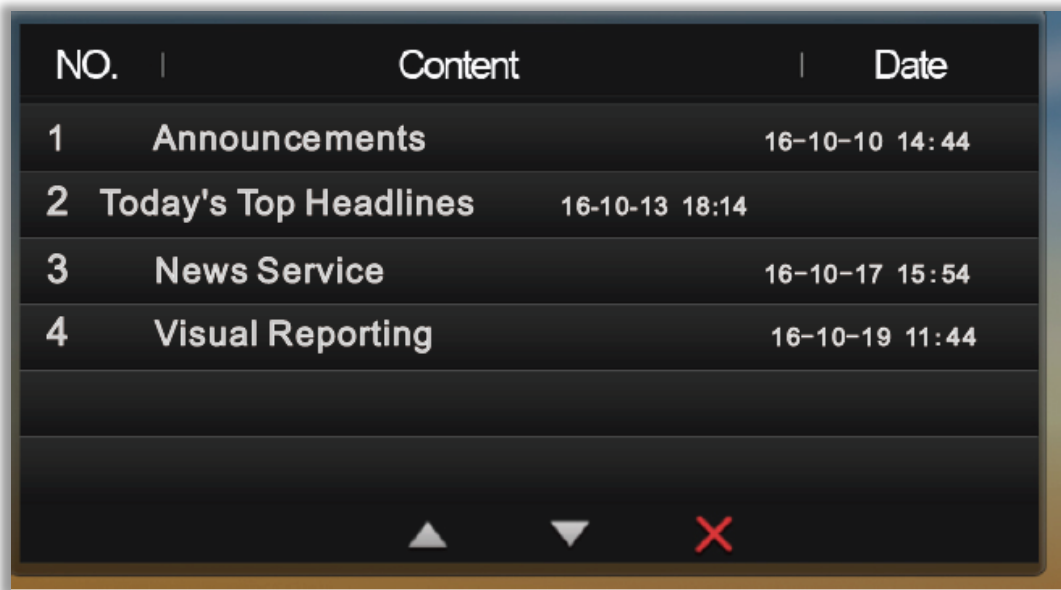

Clicking the “Message” icon, the system will enter into the following interface:



NO.	Content	Date
1	Announcements	16-10-10 14:44
2	Today's Top Headlines	16-10-13 18:14
3	News Service	16-10-17 15:54
4	Visual Reporting	16-10-19 11:44

Fig. 30 : Message interface of the Indoor Panel

Note: Only by installing the management software on a PC which is usually located at the guard center, an indoor monitor receive the message sent by the PC.

Click  icon to page up; click  icon to page down; click  icon to delete the record. Up to 64 messages can be received.

3.6. Setup

Clicking the “Setup” icon, the system will enter into the following interface:

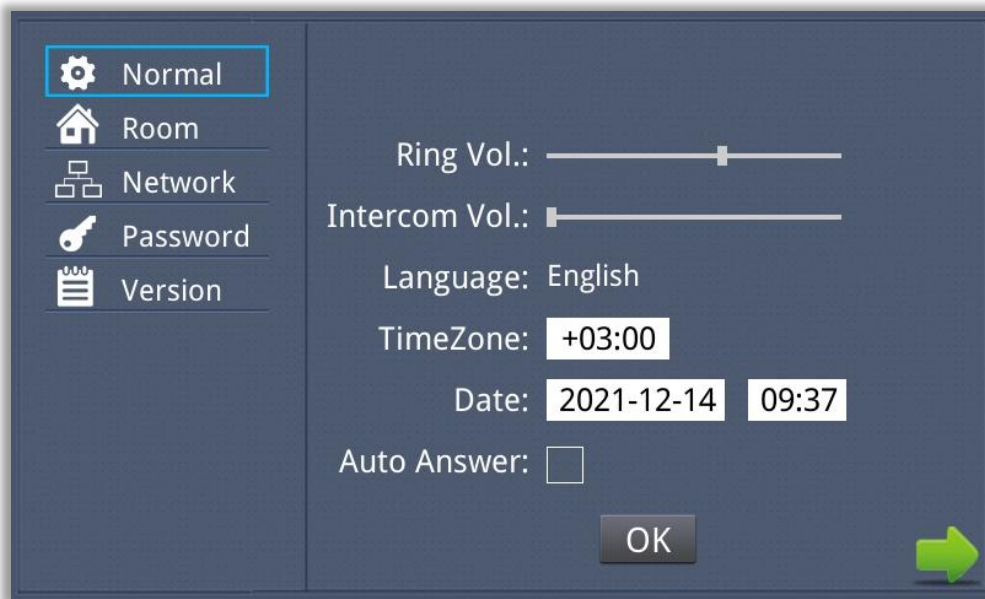

Fig. 31 : Setup interface of the Indoor Panel

3.6.1. Normal

You can select the volume, intercom, language, time zone and auto answer that you want.

3.6.2. Room

Click the “Room” icon, then input 1-16 digits password (the default password is 123456) to enter into the following interface:

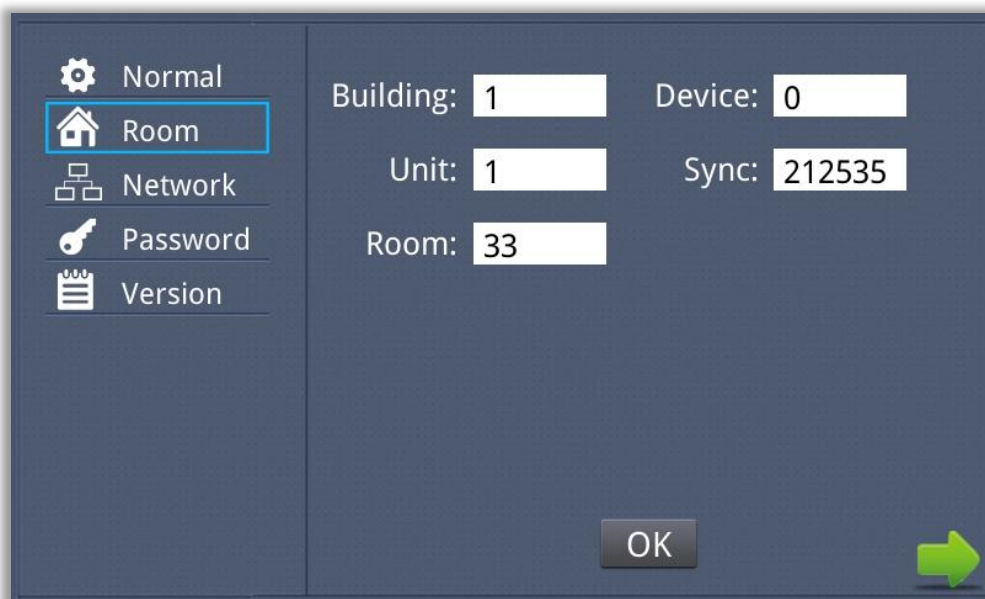

Fig. 32 : Room interface of the Indoor Panel

This information is entered by authorized persons during system commissioning. Unauthorized persons should never change the relevant settings.

3.6.3. Network

Click the “Network” icon, then input 1-16 digits password (*the default password is 123456*) to enter into the following interface:

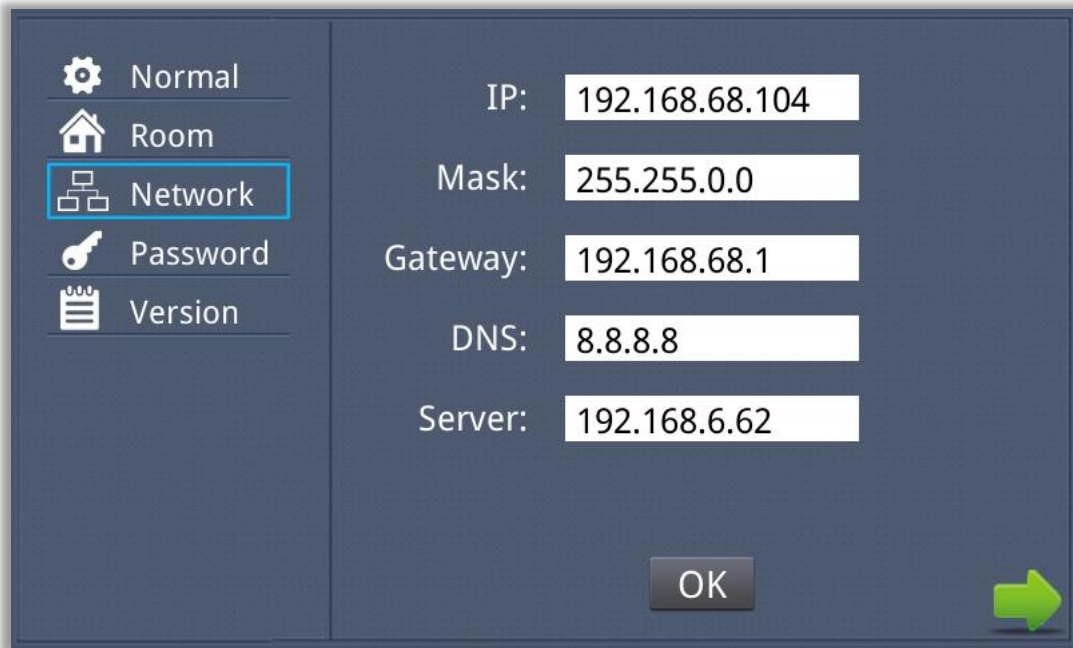

Fig. 33 : Network interface of the Indoor Panel

IP: The system will automatically display the IP address of the indoor monitor. The IP address is unique. The default Mask address is 255.255.255.0. Normally, it is unnecessary to modify.

If you would like to modify it, a keypad will pop up when clicking the setting box twice. Enter your new Mask address. The Gateway in one system must be on the same segment.

DNS: Domain name resolution address (DNS of local operator). If the indoor monitor is used on LAN, the address must be entered correctly; if it is used on LAN, the address can be ignored.

Server: If the Central Management System (CMS) is used, the IP of the computer on which the CMS is installed should be entered in this section. Click “OK” to save the settings.

This information is entered by authorized persons during system commissioning. Unauthorized persons should never change the relevant settings.

3.6.4. Password

Click the “Password” icon to enter into the following interface:

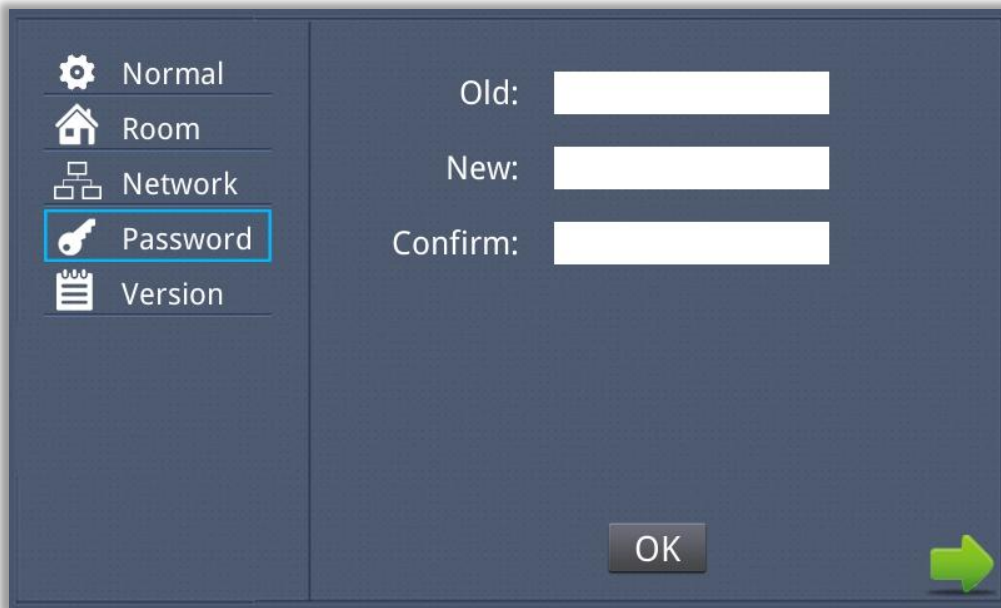

Fig. 34 : Password interface of the Indoor Panel

You can set the new system password with 1-16 digits (the default password is 123456). System password is used for system settings.

3.6.5. Version

Click the “Version” icon to enter into the following interface:



Fig. 35 : Version interface of the Indoor Panel

You can look over the relevant information.

CONTACT INFORMATION

THE INTERRA WEBSITE

Interra provides documentation support via our web site www.interratechnology.com. This website is used as a means to make files and information easily available to customers. Accessible by using your favourite Internet browser, the website contains the following information:

- Information about our products and projects.
- Overview of Interra company and values.
- Product Support: Datasheets, product manuals, application descriptions, latest software releases, ETS databases and archived software.

EUROPE, Türkiye

Interra Technology

Cumhuriyet Mah. Kartal Cad. Interra R&D Center

No:95/1 Kartal/İstanbul

Tel: +90 (216) 326 26 40 Fax: +90 (216) 324 25 03

Web adress: <http://www.interratechnology.com>