

# 'INTERRA

— *Developer of Uniqueness* —

## Residence Type Outdoor Stainless Intercom Unit **Product Manual**



## TABLE OF CONTENTS

1. Content of The Document .....	5
2. Product Description .....	6
2.1. Technical Information .....	7
2.2. Connection Diagram & Features.....	8
2.3. Troubleshooting .....	13
2.4. Safety Instructions .....	14
3. Basic Settings.....	16
3.1. Device Settings.....	17
3.2. Network Settings.....	18
3.3. Access Settings .....	20
3.4. Face Settings.....	21
3.5. Misc Settings .....	22
3.6. About System .....	23
4. Web Settings .....	24
5.1. Network Settings.....	24
5.2. Device Settings.....	25
5.3. Access Settings .....	26
5.4. VOIP .....	27
5.5. Forward (Call Transfer).....	28
5.6. Advanced Settings.....	28
5.7. Logout.....	29

Information in this publication regarding device applications and the like is provided only for your convenience and may be superseded by updates. It is your responsibility to ensure that your application meets your specifications.

INTERRA MAKES NO REPRESENTATIONS OR WARRANTIES OF ANY KIND WHETHER EXPRESS OR IMPLIED, WRITTEN OR ORAL, STATUTORY OR NONSTATUTORY, RELATED TO THE INFORMATION INCLUDING BUT NOT LIMITED TO ITS CONDITION, QUALITY, PERFORMANCE, MERCHANTABILITY OR FITNESS FOR PURPOSE.

Interra disclaims all liability arising from this information and its use. Use of Interra devices in life support and/or safety applications is entirely at the buyer's risk, and the buyer agrees to defend, indemnify and hold harmless Interra from any damages, claims, suits, or expenses resulting from such use. No licenses are conveyed, implicitly or otherwise under any Interra intellectual rights.

## Trademarks

The Interra name and logo and the Interra ITR650-0002 – Outdoor Intercom Unit with Android OS devices are registered trademarks of Interra Technology in Turkey and other countries.

All other trademarks mentioned herein are property of Interra Technology.

© 2022, Interra, Printed in Turkey, All Rights Reserved.



Printed on recycled paper.

**TS EN ISO 9001:2008**

---

**TO OUR CUSTOMERS**

---

One of our most important aims is to provide you with the best documentation possible to use successfully your Interra products. Focusing on this, we will keep on improving our documentation to better suit your needs. Our publications will be updated as new volumes as soon as changes are introduced.

If you have any questions or comments regarding this publication, do not hesitate to contact us:

E-Mail: [info@interra.com.tr](mailto:info@interra.com.tr)

Tel: +90 (216) 326 26 40 Fax: +90 (216) 324 25 03

**Most Current Product Manual**

To obtain the most up-to-date version of this product manual, please visit our Web site at:

<http://www.interratechnology.com>

You can determine the version of an Interra document by examining its literature number found on the bottom right corner of any page.

The first two letters of the literature are the type of document. The numbers that follow are the document's creation date and the last letter is the version (e.g., PM181017001A is version A of a product manual created on the date 17/10/18).

## **1. Content of The Document**

This document contains Interra brandmark's ITR650-0002 Residence Type Outdoor Stainless Intercom Unit coded devices' electronic and all essential feature information for programming these products. Each subtitle has explained the characteristics of the device. Modifications of the product and special change requests are only allowed in coordination with product management.

## 2. Product Description

ITR650-0002 is a Residence Type Outdoor Stainless Intercom Unit that is mainly used for make interaction between the related indoor intercom unit such as an indoor monitor. ITR650-0002 product features are described below :

- Video intercom with indoor monitor and management centre.
- Support unlocking by access password, IC/ID cards (ID card is optional) or facial recognition;
- It can register IC/ID card information on the outdoor panel and store up to 100,000 IC/ID cards (ID card is optional);
- Support Exit button unlocking and door magnetic detection;
- Infrared detection function

## 2.1. Technical Information

The following table shows the technical information of the ITR650-0002 intercom unit.

<b>Product Code</b>	<b>ITR650-0002</b>
<b>Power Supply</b>	DC 12 V / PoE
<b>Power Consumption</b>	3 W (Standby) 10 W (Rated)
<b>CPU</b>	Quad-Core 1.3GHz
<b>SD Ram</b>	512 MB
<b>Flash</b>	8 GB
<b>Camera</b>	1 MP CMOS
<b>Display screen</b>	4.3" TFT LCD
<b>Resolution</b>	480x272
<b>SD Card</b>	32 GB
<b>Ethernet</b>	10M/100Mbps
<b>Network Protocol</b>	SIP, TCP/IP, RTSP
<b>Reader</b>	100,000 IC/ID Cards
<b>Video Codec</b>	H.264
<b>Audio Codec</b>	G.711, G.729
<b>Lock Control</b>	1x
<b>RS 485</b>	1x
<b>Exit Button</b>	1x
<b>Type of Protection</b>	IP 55
<b>Temperature Range</b>	Operation (-10°C...55°C) Storage (-30°C...70°C)
<b>Maximum Air Humidity</b>	< 90 RH
<b>Flammability</b>	Non-flammable Product
<b>Dimensions</b>	158 x 380 x 54.5 mm (W x H x D)
<b>Configuration</b>	via Web Page

## 2.2. Connection Diagram & Features

The following diagram shows how to mount the device on a proper surface. For doing a reliable and accomplished installation, screw-down strength is less than 0.4 Nm. Once the device installation is completed, please check the connection and if needed please re-tighten the screws.

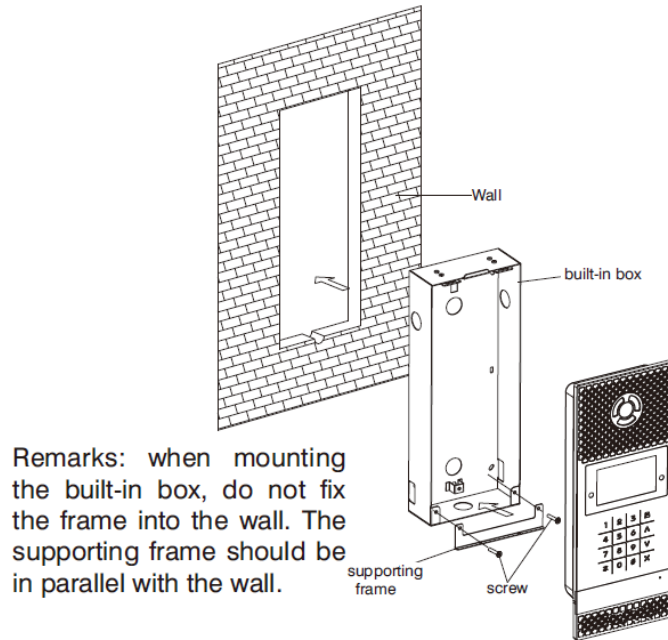

**Figure 1:** Connection Diagram of ITR650-0002 Intercom Unit

The following figure, shows the appearance dimension drawing of the Intercom Unit :

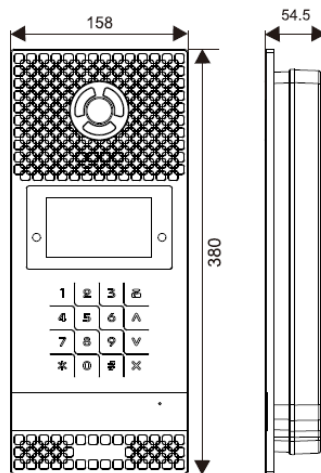

Dimensions: 158\*380\*54.5mm  
 Built-in box size: 142\*358\*59.5mm  
 Installation size: 148\*364\*65mm

**Figure 2:** Dimension Diagram of ITR650-0002 Intercom Unit



The following figure, shows the proper location of the installation :

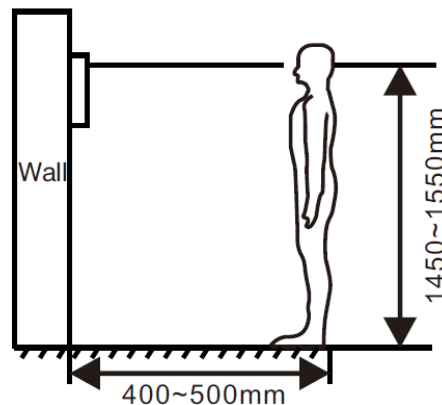

**Figure 3:** A proper location for installation (varies from person to person)

### Commissioning Instructions



- > First, according to the installation dimension of the outdoor panel, dig a square groove at the appropriate position in the wall or door, and dig a hole (drainage hole) at the bottom;
- > Then, get the hole through at the bottom of the built-in box to facilitate drainage. The upward arrow is on the front of the built-in box. Embed the built-in box into the wall, then put the built-in box into the groove of the wall, and tighten four screws from top to bottom of the built-in box, or fix the built-in box in the wall with concrete;
- > Finally, assemble the outdoor panel into the built-in box, align the groove and the built-in box, tighten the screws, and finally inject the glass glue into the top, left and right sides of the outdoor panel.

### Recommended



The glass glue cannot be injected into the bottom part that is reserved for the drainage hole at the bottom of the outdoor panel.

### Recommended



During the installation, the camera should be 1450-1550 mm above the ground. The camera tether for photographing human faces should be the top priority.

**General :**

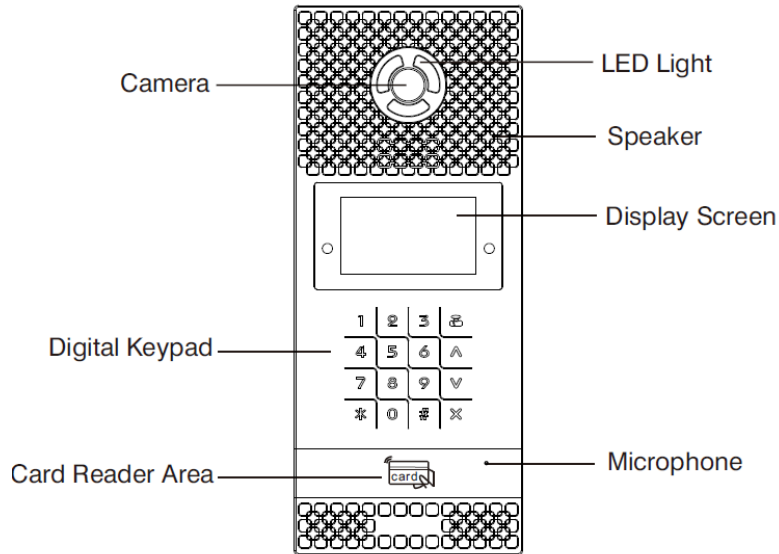

**Figure 4:** General Look of the Indoor Monitor

**System Diagram :**

The following figures show the connectors of the ITR650-0002.

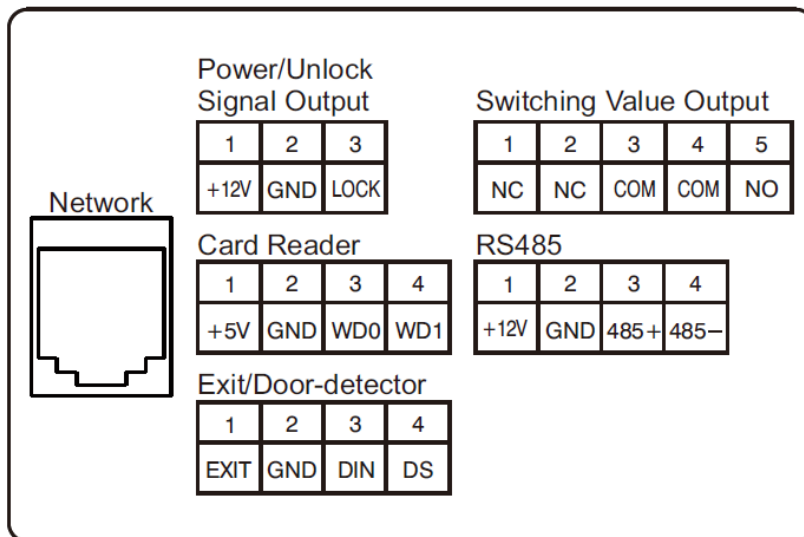

**Figure 5:** General System Diagram of the ITR650-0002

**Network**

Standard RJ45 interface connects with the management centre, indoor monitor or other network equipment by the network switch.

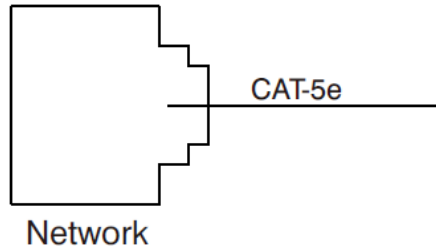

**Figure 6:** Network Cable connections

**Switching Value Output:**

Connect to the lock module(an independent power supply is necessary for the lock).

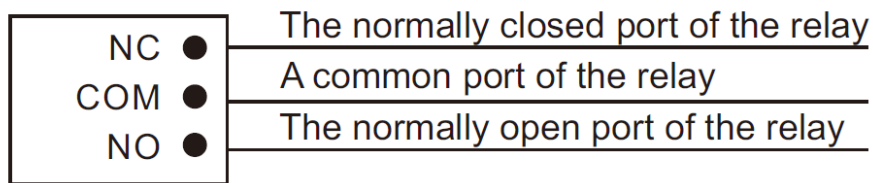

Switching Value Output

**Figure 7:** Switching Value Output connections

**RS-485:**

Connect with RS-485 device; RS-485 interface can output 12 V / 100 mA power supply. If RS-485 equipment to be connected does not require the power supply, no need to connect +12 V.

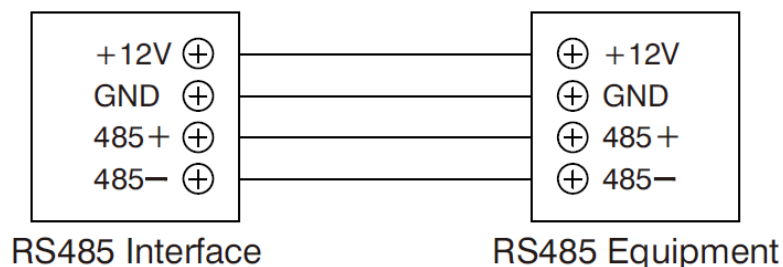

**Figure 8:** RS-485 interface pin connection

### Exit Button/Door Detector

Connect with the Exit/door detector; DIN is a reserved terminal, please do not connect it.

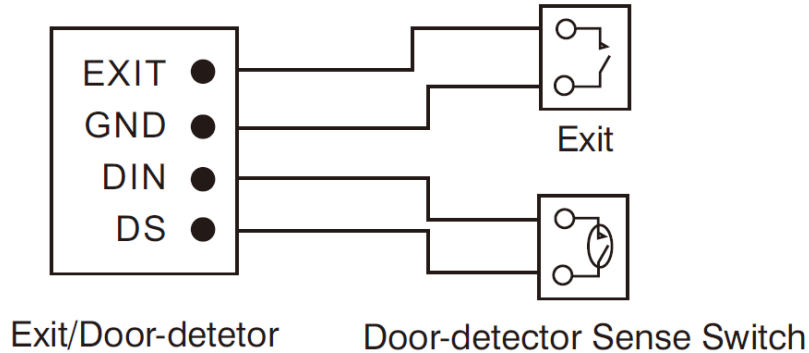

**Figure 9:** Exit Button/Door Magnetic interface pin connection

### Card Reader Interface

The interface can be connected to one IC/ID card reader or be used for reading the information of the built-in card reader. It can output power of 5 V/100 mA. When the card reader does not have them from the interface, a wired connection of +5 V is not required.

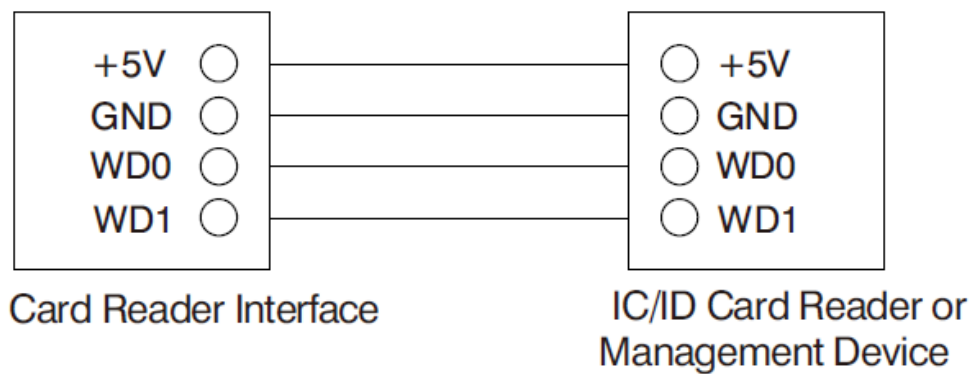

**Figure 10:** Card Reader interface pin connection

#### Special Notes



**Only one card reader can be connected to the outdoor panel. When there is a built-in card reader, the interface can only be used to read the information of the built-in card reader.**

## 2.3. Troubleshooting

Some common failures and troubleshooting methods are listed for your reference. In case of failure which cannot be repaired, do not disassemble or repair the product by yourself. Please contact the after-sales technical service department.

### When a unit panel or wall panel fails to call an indoor monitor:



When setting the outdoor panel, please make sure building No. and unit No. of the outdoor panel are the same as the ones of the indoor monitor;



Please check whether the network is connected;



Please check if there are any security settings for the network, such as VLAN configuration;

### When a unit panel, wall panel or indoor monitor fails to call the management centre:



Please check if there are any security settings for the network, such as VLAN configuration;







Please check whether the network is connected;







## 2.4. Safety Instructions

To protect you and others from harm or your device from damage, please read the following information before using the device.

### **Do not install equipment in the following places:**

-  Do not install equipment in a high-temperature and moist environment or an area close to a magnetic field, such as the electric generator, transformer or magnet.
-  Do not place the device near the heating products such as the electric heater or the fluid container.
-  Do not place the device in the sunshine or near the heat source. This might cause discolouration or deformation of the device.
-  Do not install the device in an unstable position to avoid property losses or personal injury caused by the falling of the device.

### **Guard against electric shock, fire and explosion:**

-  Do not use a damaged power cord, plug or loose outlet.
-  Do not touch the power cord with wet hands or unplug the power source by pulling the power supply.
-  Do not bend or damage the power cord.
-  Do not touch the device with wet hands.
-  Do not make the power supply slip or cause an impact.
-  Do not use the power supply without the manufacturer's approval.
-  Do not splash water or other liquids into the equipment.

## **Clean Device Surface**



Clean the device surfaces with a soft cloth dipped in some water, and then rub the surface with a dry cloth.

## **Other Matters Needing Attention**



To prevent damage to the paint layer or the case, please do not expose the device to chemical products, such as diluent, gasoline, alcohol, insect resist agents, opacifying agents and insecticide.



Do not disassemble, refit or modify the device at your discretion. The arbitrary modification is not covered under warranty. When any repair is required, please contact the customer service centre.



When the device emits an abnormal sound, smell or fume in the device, please unplug the power immediately and contact the customer service centre in time.



When the device is not used for a long time, the adaptor and memory card can be removed and placed in a dry environment.



When moving, please hand over the manual to the new tenant for proper usage of the device.



Do not press the screen surface. Overexertion might cause flop over or damage to the device.



Do not knock about the device with hard objects.

## 3. Basic Settings

In the interface shown in figure 11 or figure 12, pressing the “#” key twice, the LCD of the unit is as shown in figure 11, LCD of the wall panel is as shown in figure 12. Enter a six-digit admin password(default password: 123456) and go to settings.

Press the number key “2” or ▲ icon to page up, press the number key “8” or ▼ icon to page down; press the “#” key to confirm; press the “\*” key to return. After selecting the item to be set, press the “#” key to enter the settings or press the “\*” key to cancel the settings.



Figure 11: LCD interface section of the Outdoor Panel



Figure 12: LCD interface section of the Outdoor Panel

The outdoor panel enters the setting interface, and the LCD is shown in figure 13.

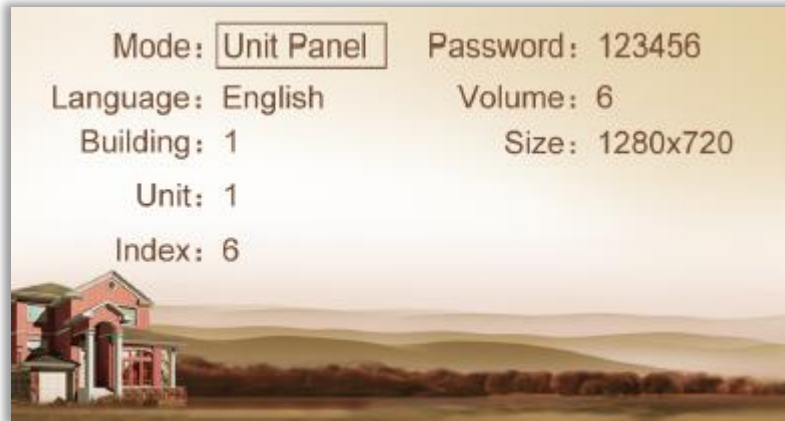

Figure 13: LCD interface section of the Outdoor Panel



## 3.1. Device Settings

Select “Device Settings” and press the “#” key to enter the device settings submenu, the LCD is as shown in figure 14.



**Figure 14:** Device Settings interface of the Outdoor Panel

### 3.1.1. Device Mode

The device can be used as a unit panel or wall panel. The device mode can be set through this item.

Press the key “#” to go to settings. The LCD screen will display as shown in Figure 15. Press the number key 2 or the icon ▲ to page up, and press the number key 8 or the icon ▼ to page down. If the device is used as a unit panel, it can only call the indoor monitors in this unit. If the device is used as a wall panel, it can call all the indoor monitors in the whole community.

Once it’s selected, press the pound key “#” to confirm. When the outdoor panel gives an indication tone, it means that it is changed successfully. Press “\*” to cancel the settings.

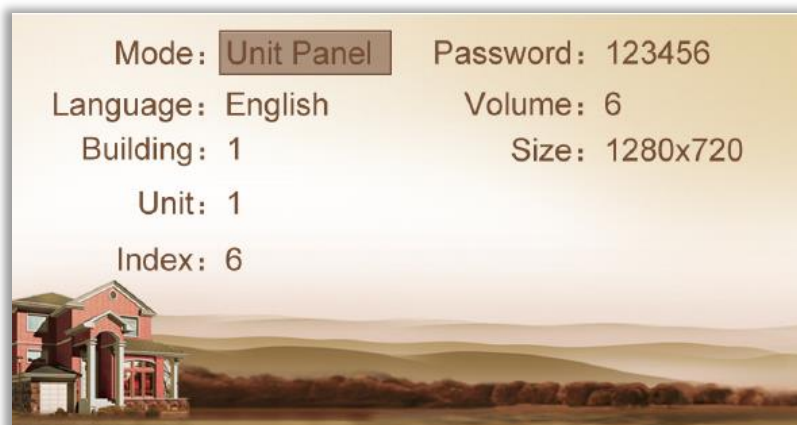

**Figure 15:** Device Mode interface of the Outdoor Panel

### 3.1.2. Language, Volume and Size

The language, volume and size (resolution) are set in the same way as the settings of device mode.

“Language” is used to set the language to be shown on the outdoor panel, supporting simplified Chinese, English and traditional Chinese.

“Volume” is used to set the prompt tone of the outdoor panel, including 1-6 volume levels selection.

There is 320x240, 640x480 or 1280x720 for the size.

### 3.1.3. Building No., Unit No., Index and Password

Select the item for setting  $\Rightarrow$  Press the pound key “#” to go to settings  $\Rightarrow$  Input the number to change  $\Rightarrow$  Press the pound key “#” to confirm  $\Rightarrow$  When the outdoor panel gives an indication tone, it means that it is changed successfully (Press the star key “\*” to cancel the settings).

#### Special Notes



**Note: Please keep the admin password confidential. If the password is forgotten, the user will not be able to log into the system. The password can only be recovered by resetting to factory defaults.**

## 3.2. Network Settings

Select “Network Settings” and press the pound key “#” to access the sub-menu. The LCD screen will show as follows:

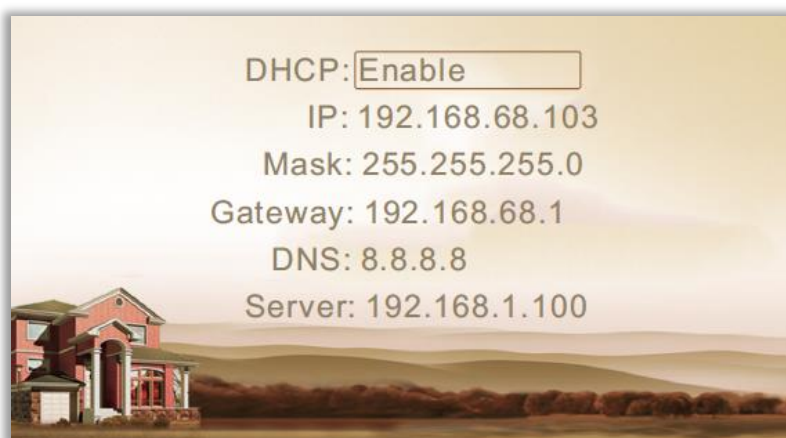

**Figure 16:** Network Settings interface of the Outdoor Panel

### 3.2.1. DHCP

Select “Network Settings” and press the pound key “#” to access the sub-menu. The LCD screen will show as follows:

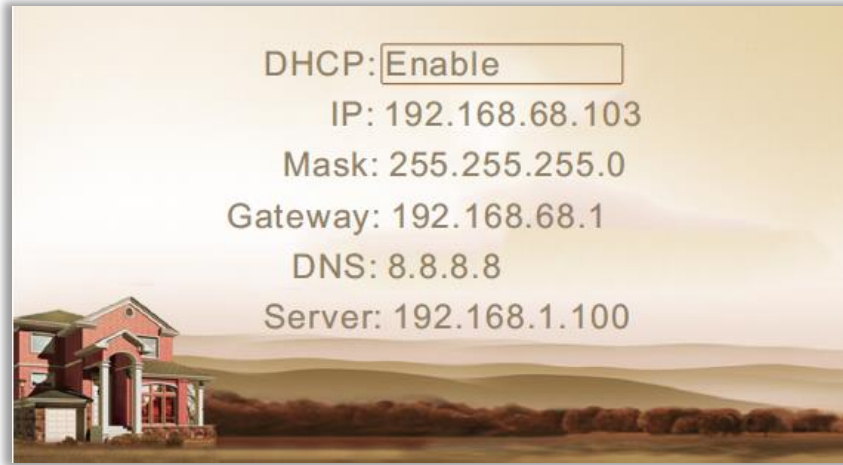

**Figure 17:** Network Settings interface of the Outdoor Panel

### 3.2.2. IP

The default IP address of the system is 192.168.68.90. The LCD screen will display as shown above. As for the devices which are connected on the same LAN (the same subnet of network segment), their IP address cannot be the same.

### 3.2.3. Mask

The system default is 255.255.255.0. The LCD screen will display as shown above.

### 3.2.4. Default Gateway

It refers to the gateway address for the network segment of the device’s IP address. The system default is 192.168.68.1. The LCD screen will display as shown above.

### 3.2.5. DNS

The system default is 8.8.8.8. The LCD screen will display as shown above.

### 3.2.6. Server

The server address refers to the IP address of the computer with management software. In case of management software is not required for managing the intercom devices, this setting is invalid. The default IP address of the server is 192.168.68.1. The LCD screen will display as shown above.

### 3.3. Access Settings

Select “Access Settings” and press the pound key “#” to access the submenu. The LCD screen will show as follows:

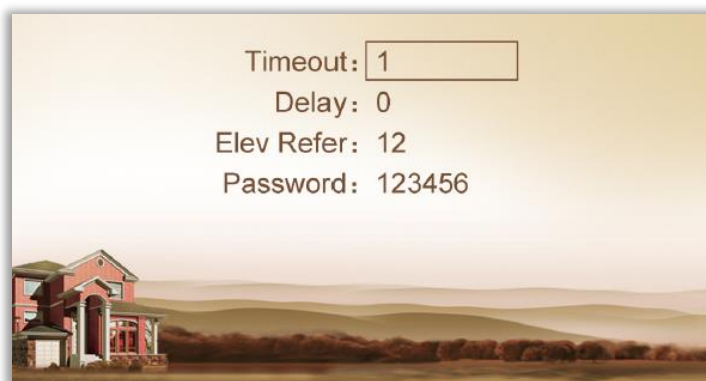
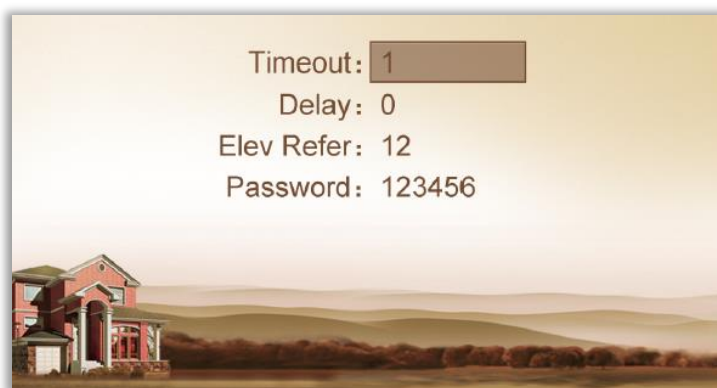

**Figure 18:** Access Settings interface of the Outdoor Panel

#### 3.3.1. Timeout

The item is used for controlling the unlocking time, namely, how long it will take the door to shut automatically after unlocking.

Select the item and press the pound key “#” to go to settings. The LCD screen will show as follows. Input any number from 1 to 9. If the user enters the number 8, it means the unlocking time is set at 8 seconds. Press the pound key “#” to confirm after inputting. When the outdoor panel gives an indication tone, it means that the time is changed successfully.



**Figure 19:** Access Settings interface of the Outdoor Panel

### 3.3.2. Delay

The item is used for setting the delayed opening time, meaning how long it will delay unlocking the door after the user presses the unlock button on the indoor monitor.

Select the item and press the pound key “#” to go to settings. The LCD screen will display as shown above. Input any number from 1 to 9. If the user enters the number 5, it means the delayed opening time is set at 5 seconds.

Press the pound key “#” to confirm after inputting. When the outdoor panel gives an indication tone, it means that the time is changed successfully.

### 3.3.3. Password

The item is used for setting the password to unlock the door. Enter the passwords and then press the pound key “#” to confirm. The LCD screen will display as shown above.

### 3.3.4. Elev Refer (This item can only be used after connection to elevator control devices)

The item is used for setting the floor of the outdoor panel.

Select the item and press the pound key “#” to go to settings. The LCD screen will display as shown above. Set floor No. Of outdoor panels ranging from 01 to 99. After the door is unlocked, the elevator will reach the floor of the outdoor panel.

Press the pound key “#” to confirm after inputting. When the outdoor panel gives an indication tone, it means that is changed successfully.

## 3.4. Face Settings

Select “Face Settings” and press the pound key “#” to access the sub-menu. The LCD screen will show as follows:

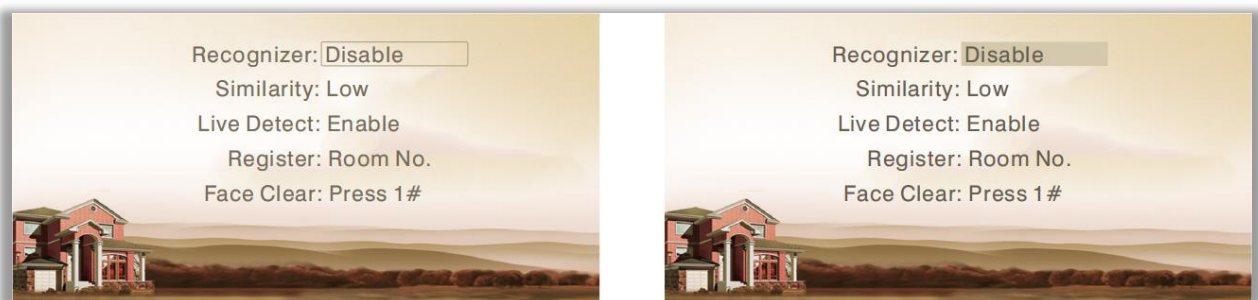

**Figure 20:** Face Settings interface of the Outdoor Panel

The item “Recognizer” is used for setting the state of the recognizer function. “Disable” means the function has been closed. Select the item and press the pound key “#” to go to settings. The LCD screen will display as shown above.

The item “Similarity” is used for setting the face similarity. There are 3 levels to choose from. Select the item and press the pound key “#” to go to settings.

The item “Live Detect” means if you can move when being recognized. Select the item and press the pound key “#” to go to settings.

The item “Register” is used for recording the new face. Enter the Room number and then register the face on the system of the outdoor panel. When the system gives a prompt tone, it means the registration is completed.

The item “Face Clear” is used for clearing the registered information. Enter 1 and then press the pound key “#” to confirm.

### 3.5. Misc Settings

Select “Misc Settings” and press the pound key “#” to access the submenu. The LCD screen will show as follows:

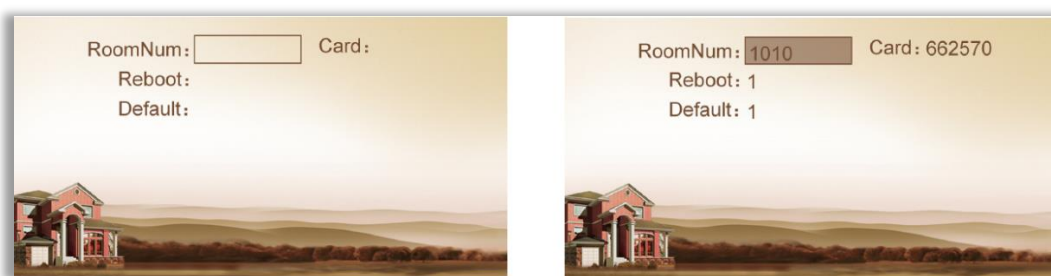

**Figure 21:** Misc Settings interface of the Outdoor Panel

The item “RoomNum” is used for registering the access card corresponding to the room number. Select the item and press the pound key “#” to go to Settings. The LCD screen will display as shown above.

Enter the room number and then place the access card close to the swiping area. When the outdoor panel gives an indication tone, it means that the card has been registered successfully. Then the No. of the registered card will be displayed.

The item “Reboot” is used for restarting the outdoor panel. Enter the number “1” and then press the pound key “#” to confirm. The system will restart automatically. Entering any number other than “1” is invalid.

The item “Default” is used for resetting to the system default. Enter the number “1” and then press the pound key “#” to confirm. The system will restart automatically. Entering any number other than “1” is invalid.

The item “Default” is used for resetting to the system default. Enter the number “1” and then press the pound key “#” to confirm. The system will be reset. Entering any number other than “1” is invalid.

## 3.6. About System

Select "About System" and press the pound key "#" to access the sub-menu. The LCD screen will show as follows:



**Figure 22:** About System Information of the Outdoor Panel

## 4. Web Settings

Connect the outdoor panel and PC in the switch and make them on the same LAN. Input the IP address of the outdoor panel in the web browser of the PC, then input the user name and password(the default name is admin, the password is 123456) to enter into the following interface:



Figure 23: Web Settings general interface of the Indoor Panel

### 5.1. Network Settings

Click the icon “Network” on the interface to enter into the following interface:



Figure 24: Web Settings network interface of the Indoor Panel

**DHCP:** Dynamic IP function.

**IP:** The IP address should be unique in the same Network.

**Mask:** The default subnet mask is 255.255.255.0.

**Gateway:** It depends on the IP address.

**DNS:** It depends on Network.

**Server IP:** It is the same as the IP address of the management PC.



Usually, the communication among the management centre, indoor monitor and outdoor panel will be available on the same LAN; if they are not on the same network, you need to set SIP server to support the communication.

Click the “Submit” icon to confirm settings.

## 5.2. Device Settings

Click the “Device” icon on the interface to enter into the following interface:



**Figure 25:** Device Settings Interface of the Outdoor Intercom

The settings of the building and Unit No. should be the same as that of the corresponding outdoor panel.

**No.:** It is a unique number for the outdoor panel. You can have max.9 outdoor panels in one house, and you need to distinguish their numbers from 1 to 9.

**Sys password:** You can change the login password as you like (the default password is 123456).

**Panel mode:** Unit panel, wall panel or personal panel for selection.

- **Unit Panel:** Used in one unit, it can call residents in the unit and management centre;
- **Wall Panel:** Used at the entrance of the community, it can call all indoor monitors in the community and management centre;
- **Personal Panel:** It is reserved.

You can choose a different ringtone and language, and can also adjust the ringing volume.

Click the “Submit” icon to confirm settings.

## 5.3. Access Settings

Click the “Access” icon on the interface to enter into the following interface:

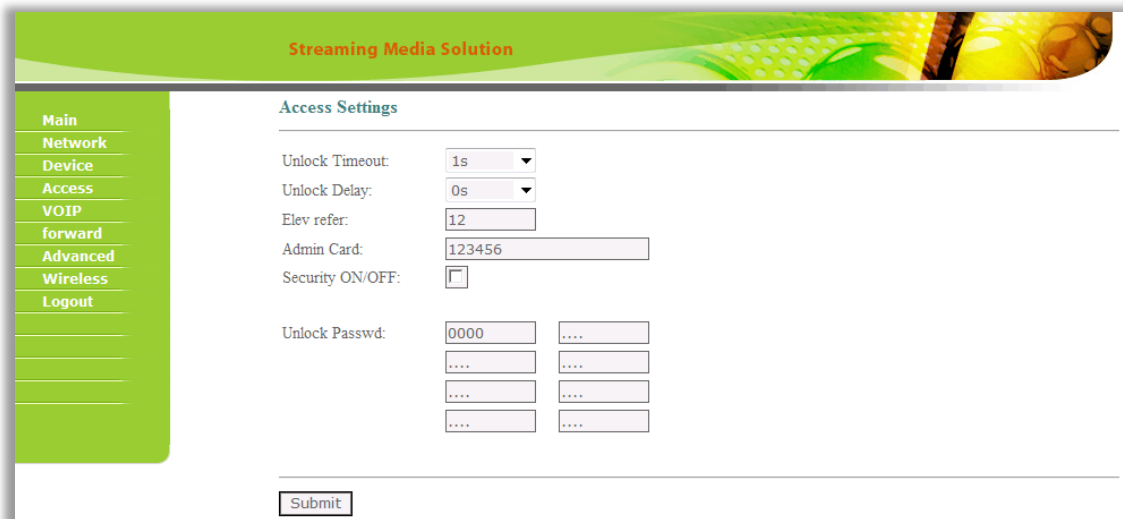

**Figure 26:** Web Access Settings interface

Unlock Timeout is used for controlling time ranging from 1 to 9 seconds.

Unlock Delay refers to the delayed opening time ranging from 0 to 9 seconds. Elev refer is used for setting the floor of outdoor panels ranging from 01 to 99.

**Security ON/OFF:** arming/disarming by card is only effective for the secondary outdoor panel; the unit panel only supports disarming by card.

**Unlock Password:** It's used for unlocking the door. The system default is 0000. Eight unlocking passwords can be added. (This is only applicable for outdoor panels with the keypads.)

### **Card Registration**

The Admin Card is used for registering the user card. There are two ways of registering the admin card:

- The user enters card No. of the admin card in the box after “Admin Card” and then click the key “Submit”. In this case, the admin card is registered successfully.
- If the user is not aware of admin card No., please enter 0 in the box first and click the key “Submit”. Then place the admin card close to the swiping area. When the system gives an indication tone, it means that the admin card is registered successfully.

When registering the user card, the user shall swipe the admin card first. The system emits a beep. Then place the card to be registered near the swiping area within 10 seconds. If the system gives an indication tone, it means that the user card is registered successfully. When registering the user card, the card to be registered shall swipe 10 seconds after the admin card is swiped. Once a user card is registered, it will postpone for 10 seconds. When there is no activity for 10 seconds, the system will exit from registration status automatically. To register a new user card, the user shall swipe the admin card again.

## 5.4. VOIP

Click the icon “VOIP” on the interface to enter the following interface:



**Figure 27:** SIP Settings interface of the outdoor intercom

**SIP enables:** When SIP account No. is enabled, the SIP server of a third party is generally used.

**Proxy:** URL of SIP proxy server in the format: [sip:ip](#) or [sip:domain](#) name.

**Realm:** Realm of the device, usually the same as IP or domain name.

STUN IP and Port refer to the IP and port of the public server for NAT traversal of audio and video.

**Bitrate:** 128K, 384K, 512K, 768K, 1M or 2M.

**User:** User name assigned by SIP server.

**Password:** The password assigned by the SIP server.

**Timeout:** 120 seconds, 300 seconds, 600 seconds, 1200 seconds or 1800 seconds.

**Ringling:** The ringing time of the indoor monitor which is called by the outdoor panel can be set. The time can be set at 35 seconds, 45 seconds, 60 seconds, 90 seconds or 120 seconds.

Once this is set up, click the key “Submit” to enable new settings.

## 5.5. Forward (Call Transfer)

Click the “Forward” icon on the interface to enter into the following interface:

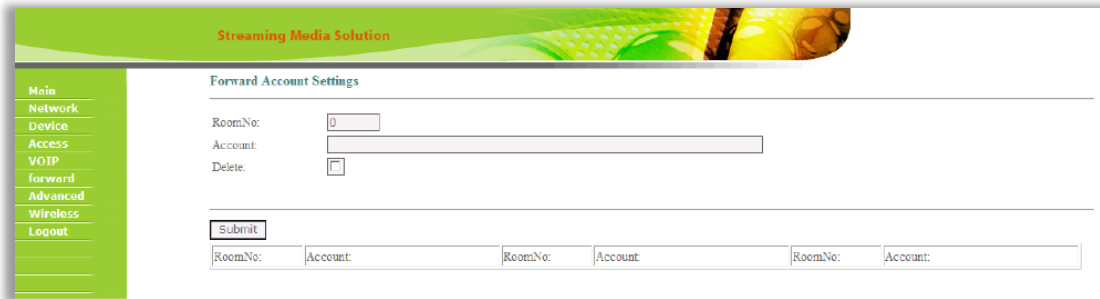

Figure 28: Web Settings Call Forwarding interface

Room No. Can be found with the phone number. When the visitor calls on the outdoor panel but there is no answer within 25 seconds, the system will forward the call to the phone. Please follow the detailed steps:

- Enter room No. and then enter the account phone number to be bound;
- To delete this account, check the box;
- Once this is set up, click the key “Submit” to enable new settings.

(**Note:** This item requires the support of an extension module or local SIP service provider.)

## 5.6. Advanced Settings

Click the icon “Advanced” on the interface to enter into the following interface:

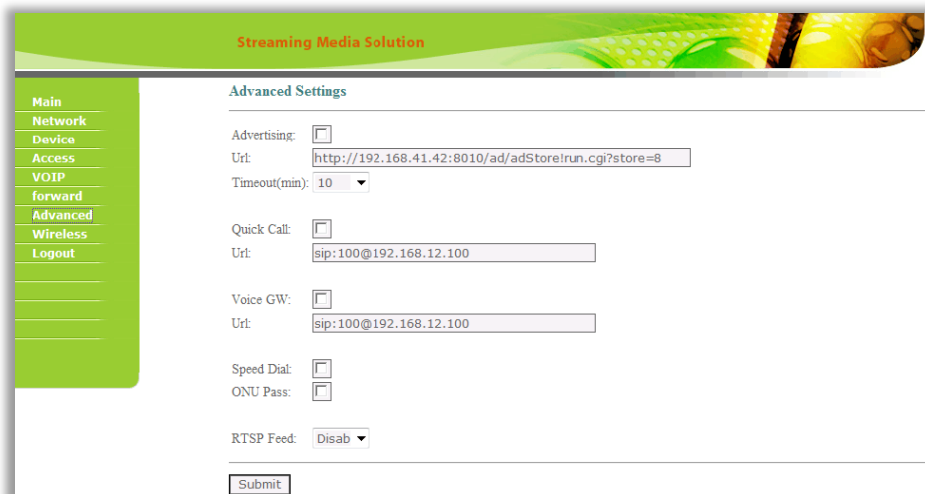

Figure 29: Web Advanced Settings interface

**Advertising:** Check the box to enable this function. Enter the specified advertisement URL in the box. The interface will play the online advertisement automatically.

**Quick Call:** Check the box to enable this function. It refers to the call to the management centre. Enter the SIP address of the specified management centre. The call can be from an indoor monitor or SIP internet phone of other manufacturers.

Speed Dial: Press one number key to give a direct call.

Once this is set up, click the key “Submit” to enable new settings.

## 5.7. Logout

Click the “Logout” icon on the interface to enter into the following interface:



**Figure 30:** Other Settings interface

Click the “Submit” icon to log out of the system.

---

---

**CONTACT INFORMATION**

---

**THE INTERRA WEBSITE**

Interra provides documentation support via our website [www.interratechnology.com](http://www.interratechnology.com). This website is used as a means to make files and information easily available to customers. Accessible by using your favourite Internet browser, the website contains the following information:

- Information about our products and projects.
- Overview of Interra company and values.
- Product Support: Datasheets, product manuals, application descriptions, latest software releases, ETS databases and archived software.

**EUROPE, Turkey**

Interra

Cumhuriyet Mah. Kartal Cad. Simkan Plaza No:95/1  
Kartal/İstanbul

Tel: +90 (216) 326 26 40 Fax: +90 (216) 324 25 03

Web adress: <http://www.interratechnology.com>