

Multi Presence Detector



Product Code	ITR415-0XXX
Sensor Technology	Passive Infrared
Power Supply	KNX Bus
Installation environment	Indoor
Current Consumption	5 mA
Brightness Detection	1-1200 lux
Inputs	3 Inputs
	2 x Digital Input and 1 x Digital /Analog Input
Maximum Air Humidity	% 90 RH
Pollution Degree	2
Type of Protection	Flush Mount : IP 20
	Surface Mount : IP 44
Temperature Range	Operation (-5°C...45°C)
	Storage (-10°C...60°C)
Dimensions	70 × 41,8 mm (Φ x H)
Colour	Black and White
Certification	KNX Certified
Configuration	Configuration with ETS

DESCRIPTION

Multi Presence Detector is a multi-functional device suitable for indoor usages with detection capability. It includes 4 independent presence channels that can be used with constant light switch and constant light controller functionality. Independent presence channels can be configured as the automatic or semi-automatic mode for user requirements. Moreover, ITR415-0XXX also supports sensor functionality without presence channels for simple usage. Temperature measurements can be made via an integrated temperature sensor and temperature information can be reported to KNX bus. ITR415-0XXX also includes 4 independent logic blocks to make logical associations. The logical blocks can be associated with such as “AND”, “OR” and “XOR” logic. The logic input conditions contain presence, brightness, movement and external conditions. The sensor also can be configured as the master or slave mode. The thermostat feature can be utilized with an internal or external temperature.

MODELS & VARIATIONS

ITR415-0X₁X₂X₃

X₁: Colour X₂: Thermostat Status X₃: Product Type

X ₁	Colour	X ₂	Thermostat Status
0	White	0	No thermostat
1	Black	1	Thermostat
X ₃	Product Type		
1	Mid-Range		
2	Mid-Range Plus		
3	Wide Range Plus		
4	High Bay		
5	High Bay Plus		
6	Microwave		

FUNCTIONS

- ITR415-0XXX supports presence detection, brightness detection, movement detection, internal and external temperature detection.
- Presence detection, based on a passive infrared sensor or microwave have 4 independently configurable channels with constant light switch and constant light control application.
- ITR415-0XXX have 4 logic function blocks and can be set in the logical relation AND/OR/XOR. Each block can control 5 output objects.
- Via 2 digital inputs and 1 digital/analog input, external devices can be connected.
- Switch sensor, switch/dimming sensor, shutter sensor, value/forced operation, scene control, RGB colour control and HVAC mode selection control can be made with buttons that are connected to the inputs
- Temperature measuring through the integrated sensor, analog input or KNX temperature sensor with possibility of sending the value on change and periodically to the bus for monitoring the room temperature.
- The device also integrates the “Virtual Card Holder”; the field of application is the hotel room: through a magnetic sensor installed on the door and connected to a digital input, accurate presence information is managed.
- The sensing range for detecting people sitting, walking towards and walking across are different sizes. The sensing range of the detector changes depending on the mounting height.
- With the function of the constant light controller: The detector keeps the brightness at a constant value, and it will dim the lights to the corresponding intensity according to the surrounding brightness.
- The thermostat feature can be utilized with an internal or external temperature.

DETECTION RANGE

ITR415-0XX1 - Mid-Range

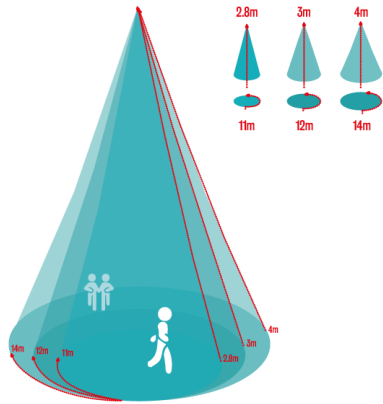

Mounting Height	Seated Activity	Walking Towards	Walking Across
2.8 m	5.5 m	6 m	11 m
3 m	6 m	7 m	12 m
4 m	7 m	8 m	14 m

ITR415-0XX2 - Mid-Range Plus

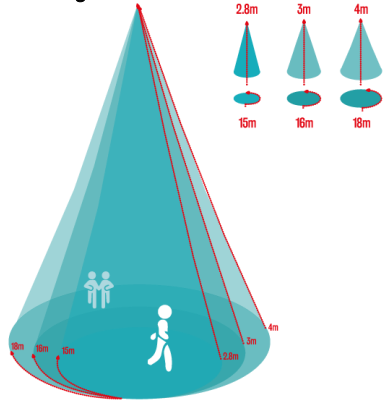

Mounting Height	Seated Activity	Walking Towards	Walking Across
2.8 m	6 m	9 m	15 m
3 m	6.5 m	11 m	16 m
4 m	7 m	12 m	18 m

ITR415-0XX3 - Wide-Range

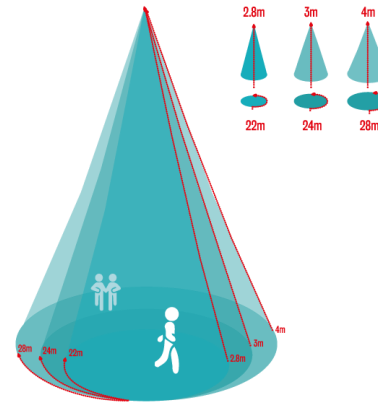

Mounting Height	Seated Activity	Walking Towards	Walking Across
2.8 m	6 m	12 m	22 m
3 m	7 m	14 m	24 m
4 m	7.5 m	16 m	28 m

ITR415-0XX6 - Microwave

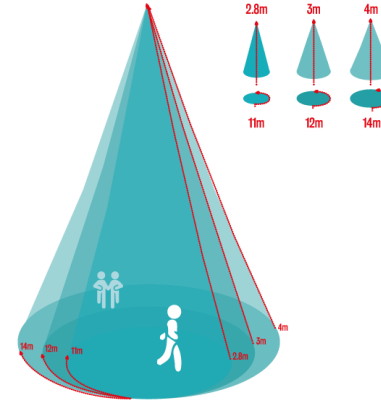

Mounting Height	Seated Activity	Walking Towards	Walking Across
2.8 m	5.5 m	6 m	11 m
3 m	6 m	7 m	12 m

ITR415-0XX4 - High Bay

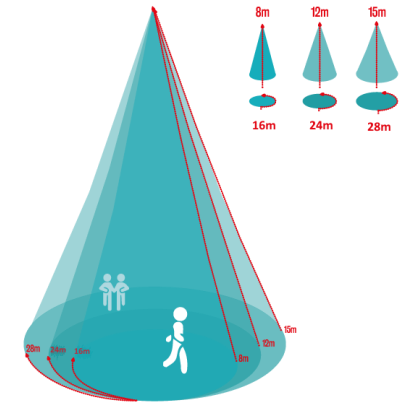

Mounting Height	Walking Across
4 m	8 m
8 m	16 m
12 m	24 m
15 m	28 m

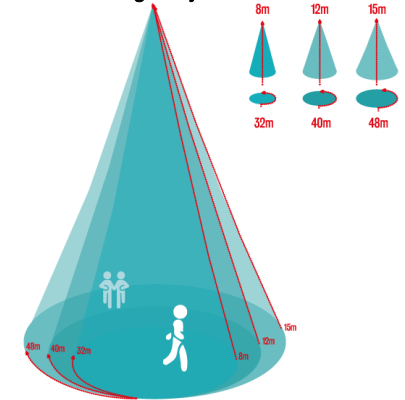

ITR415-0XX5 - High Bay Plus



Mounting Height	Walking Across
4 m	16 m
8 m	32 m
12 m	40 m
15 m	48 m

USEFUL INSTALLATION TIPS

As the sensor reacts to temperature changes, the following conditions should be avoided:

-  Avoid targeting the sensor toward the objects which may be swayed in the wind, such as curtain, tall plants, miniature etc.
-  Avoid targeting the sensor toward the objects whose surfaces are highly reflective, such as mirror, glass and pool, etc.
-  The sensor should be mounted away from heat sources such as air conditioning, lights, heating vents etc.

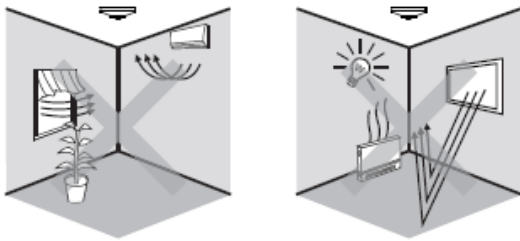

ADDITIONAL TEMPERATURE PROBE



The table below lists the Temperature Probe compatible with our product. The Temperature Probe is not supplied with the product and customers must order this probe separately.

Product Code	HM001718
Description	Thermistor NTC 10K 5%
Cable Cross-section	24 AWG
Cable Length	1.5 m
Pin Count	2

TECHNICAL DRAWINGS

Technical drawings and dimensions for flush mounted and surface mounted sensor models are given below. All dimensions specified for technical drawings are in millimeters.

Flush Mounted:

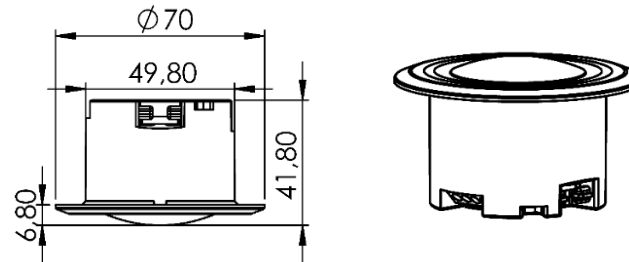

Surface Mounted:

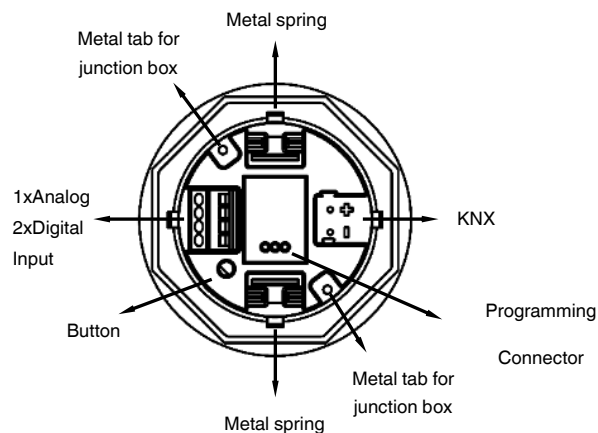
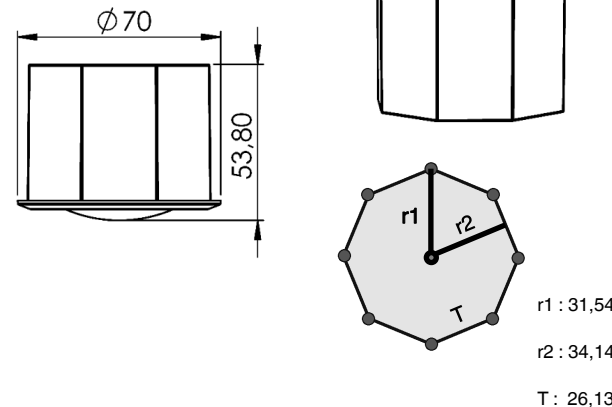

MOUNTING

The device can be mounted either in the ceiling via flush mounting housing or on the ceiling via the optionally available surface-mounted box.

Flush Mount Process:

- First, a slot hole of suitable size for sensor mounting is opened on the ceiling surface to be flush mounted.
- Then, KNX cable and input cable, if any, are connected to the relevant connectors on the sensor.
- The 2 metal springs on the sensor are stretched and then the sensor is attached to the hole on the ceiling. Thus, mounting process is finished.

Surface Mount Process:

- First, a hole of suitable size for cables is opened on the ceiling surface.
- Second, the octagonal surface junction box where the sensor will be placed is screwed to the ceiling.
- Then, KNX cable and input cable, if any, are connected to the relevant connectors on the sensor.
- The 2 metal springs on the sensor housing are removed and then the metal tabs are attached to the sensor housing. Then, the sensor is mounted to junction box. Thus, mounting process is completed.

CALIBRATION

There is the option of carrying out a brightness adjustment for the sensor via the brightness detection application with the aid of the ETS parameters and objects.

Calibration Procedure:

- Perform the measurement during sufficient daylight ($> 1/2 * \text{setpoint}$).
- Switch off the light source.
- Carry out the measurement of brightness at a defined location with a luxmeter. For instance, lying down at the workplace with a view toward the ceiling and wait until the light is close to being constant. Send the value to the device using the brightness calibration object via ETS as soon as possible after measuring.

IMPORTANT NOTES

- For planning and construction of electric installations the appropriate specifications, guidelines and regulations in force of the respective country have to be complied.
- Special Programming: ITR415-0XXX is designed for professional KNX installation. It only can be programmed by ETS software.
- Voltage: The input voltage shall be 21-30 V DC.
- Mounting Location: Installed indoors, to avoid installation near the air-conditioner vent, and be away from the heat source. DS2410080175G

Multi Presence Detector



Ürün Kodu	ITR415-0XXX
Sensör Teknolojisi	Pasif Kızılötesi
Güç Kaynağı	KNX Güç Kaynağı
Kurulum Ortamı	İç Mekan
Akım Tüketimi	5 mA
Parlaklık Aralığı	1-1200 lux
Girişler	3 Giriş 2 x Dijital Giriş ve 1 x Dijital/Analog Giriş
Maksimum Nem Oranı	% 90 RH
Kirlilik Seviyesi	2
Koruma Seviyesi	Sıva Altı : IP 20 Sıva Üstü : IP 44
Sıcaklık Aralığı	Çalışma (-5°C...45°C) Depolama (-10°C...60°C)
Boyutlar	70 x 41,8 mm (Φ x H)
Renk	Siyah ve Beyaz
Sertifika	KNX Sertifikası
Yapılandırma	ETS ile Yapılandırma

AÇIKLAMA

Multi Presence Detector varlık sensörü, iç mekan kullanımları için uygun geniş aralık algılama özelliğine sahip çok işlevli bir cihazdır. Sabit ışık anahtarı ve sabit ışık kontrolü işlevselliği ile kullanılabilen 4 bağımsız varlık kanalı içerir. Bağımsız varlık kanalları, kullanıcı gereksinimleri için otomatik veya yarı otomatik mod olarak yapılandırılabilir. Bununla birlikte, ITR415-0XXX, basit kullanım için varlık kanalları kullanımına ihtiyaç olmadan sensör işlevselliğini de destekler. Entegre sıcaklık sensörü aracılığıyla sıcaklık ölçümleri yapılabilir ve sıcaklık bilgileri KNX bus hattına gönderilebilir. ITR415-0XXX ayrıca mantıksal ilişkiler kurmak için 5 bağımsız mantık bloğu içerir. Mantıksal bloklar, "VE", "VEYA" ve "ÖZEL VEYA" gibi mantıksal operatörler ile ilişkilendirilebilir. Mantıksal girdi koşulları, varlık, parlaklık, hareket ve dış koşullarını içerir. Sensör ana cihaz ya da bağımlı cihaz (master/slave) modunda kullanılabilir. Dahili veya harici sıcaklık ile termostat özelleği kullanılabilir.

MODELLER & VARYOSYONLAR

ITR415-0X₁X₂X₃X₁: RenkX₂: Termostat durumuX₃: Ürün Tipi

X ₁	Renk	X ₂	Termostat Durumu
0	Beyaz	0	Termostatsız
1	Siyah	1	Termostatlı
X ₃	Ürün Tipi		
1	Mid-Range		
2	Mid-Range Plus		
3	Wide Range Plus		
4	High Bay		
5	High Bay Plus		
6	Microwave		

FONKSİYONLAR

- ITR415-0XXX, varlık algılaması, parlaklık algılaması, hareket algılaması, dahili ve harici sıcaklık algılaması özelliklerine sahiptir.
- Birbirinden bağımsız ayarlanabilen sabit ışık anahtar(aç/kapa) ve sabit ışık kontrol(dimleme) olmak üzere 4 kanallı varlık algılama özelliği bulunmaktadır. Temel özelliklere sahip kullanımlar için de 1 adet sensör kanalı vardır.
- ITR415-0XXX, 4 mantıksal fonksiyon bloğuna sahiptir ve mantıksal ilişkilendirme VE / VEYA / ÖZEL VEYA işlemleriyle yapılabilir. Her blok 5 çıkış objesini kontrol edebilmektedir.
- 2 dijital giriş ve 1 analog giriş üzerinden harici cihazlar bağlanabilir.
- Girişlere bağlanan butonlar ile anahtar, anahtar / dimleme, perde / panjur, değer / değere zorlama, senaryo, RGB renk kontrolü ve HVAC mod seçim kontrolü yapılabilmektedir.
- Değişim anında ve periyodik olarak oda sıcaklığının izlenmesi için KNX bus hattına dahili sensör, analog giriş veya KNX sıcaklık sensörü ile ortam sıcaklığı değeri gönderme.
- Cihaz ayrıca "Sanal Kart Sahibini" entegre eder; uygulama alanı otel odasıdır: kapıya monte edilen ve dijital bir girişe bağlanan bir manyetik sensör aracılığıyla, doğru varlık bilgisi yönetilir.
- Sabit ışık seviyesi kontrol fonksiyonu: Dedektör, parlaklığı sabit bir değerde tutar. Ortamdaki parlaklığa göre aydınlatmalar artırma veya azaltma şeklinde dimlenerek istenen değere ulaşılır.
- Dahili veya harici sıcaklık ile termostat özelleği kullanılabilir.

ALGILAMA MESAFELERİ

ITR415-0XX1 - Mid-Range

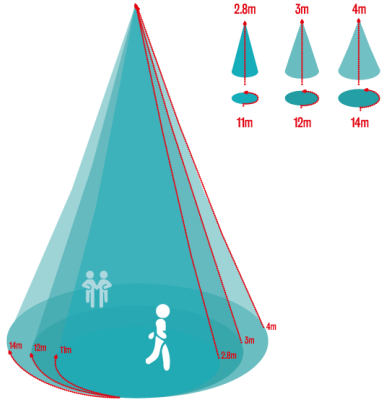

Montaj Yüksekliği	Varlık Algılama	Doğru Yürüme	Teğet Yürüme
2.8 m	5.5 m	6 m	11 m
3 m	6 m	7 m	12 m
4 m	7 m	8 m	14 m

ITR415-0XX2 - Mid-Range Plus

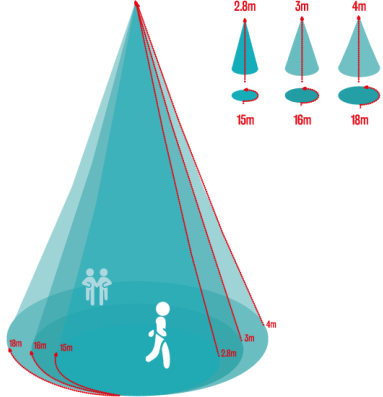

Montaj Yüksekliği	Varlık Algılama	Doğru Yürüme	Teğet Yürüme
2.8 m	6 m	9 m	15 m
3 m	6.5 m	11 m	16 m
4 m	7 m	12 m	18 m

ITR415-0XX3 - Wide-Range

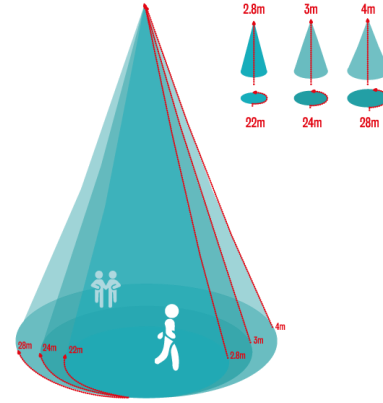

Montaj Yüksekliği	Varlık Algılama	Doğru Yürüme	Teğet Yürüme
2.8 m	6 m	12 m	22 m
3 m	7 m	14 m	24 m
4 m	7.5 m	16 m	28 m

ITR415-0XX6 - Microwave

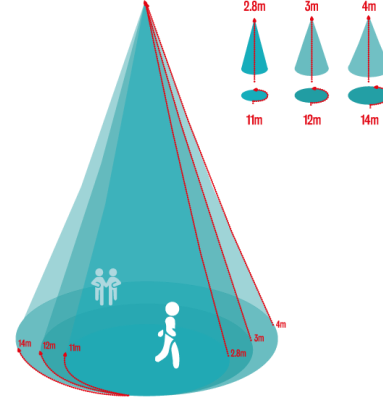

Montaj Yüksekliği	Varlık Algılama	Doğru Yürüme	Teğet Yürüme
2.8 m	5.5 m	6 m	11 m
3 m	6 m	7 m	12 m

ITR415-0XX4 - High Bay

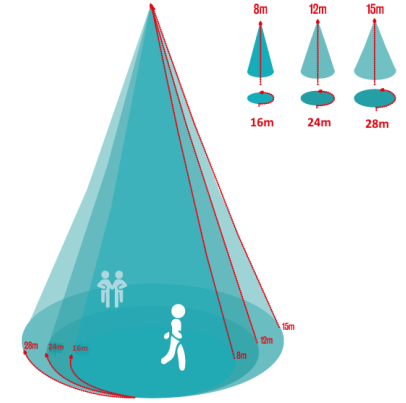

Montaj Yüksekliği	Teğet Yürüme
4 m	8 m
8 m	16 m
12 m	24 m
15 m	28 m

ITR415-0XX5 - High Bay Plus

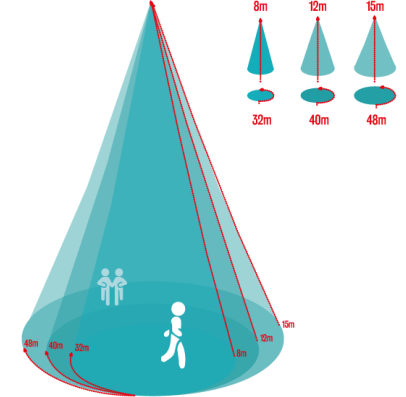

Montaj Yüksekliği	Teğet Yürüme
4 m	16 m
8 m	32 m
12 m	40 m
15 m	48 m

KURULUM ÖNERİLERİ

Sensör sıcaklık değişikliklerine tepki gösterdiğinden, aşağıdaki koşullardan kaçınılmalıdır:

- ⚠ Sensörün perde, uzun bitkiler, minyatür vb. gibi rüzgarda sallanabilecek nesnelere doğru hedeflemekten kaçınılmalıdır.
- ⚠ Sensörü, ayna, cam ve havuz gibi yüzeyleri yüksek oranda yansıtıcı olan nesnelere doğru hedeflemekten kaçınılmalıdır.
- ⚠ Sensör, klima, ışıklar, ısıtma delikleri vb. ısı kaynaklarından uzağa monte edilmelidir.

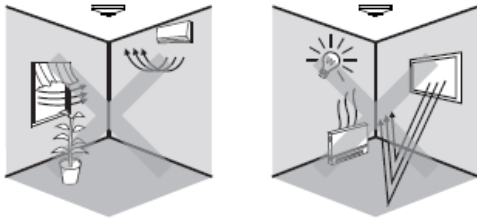

EK SICAKLIK PROBU



Aşağıdaki tabloda, ürünümüze uyumlu Sıcaklık Probu listelenmektedir. Sıcaklık Probu, ürünle birlikte temin edilmemektedir ve müşterilerin bu probu ek olarak sipariş vermeleri gerekmektedir.

Ürün Kodu	HM001718
Açıklama	Termistör NTC 10K 5%
Kablo Kesidi	24 AWG
Kablo Uzunluğu	1.5 m
Pin Sayısı	2

TEKNİK ÇİZİMLER

Sıva altı ve sıva üstü sensör modelleri için teknik çizimler ve boyutlar aşağıda verilmiştir. Teknik çizimler için belirtilen tüm ölçüler milimetre cinsindedir.

Sıva Altı:

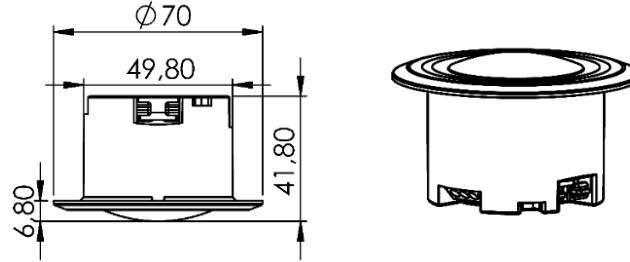

Sıva Üstü:

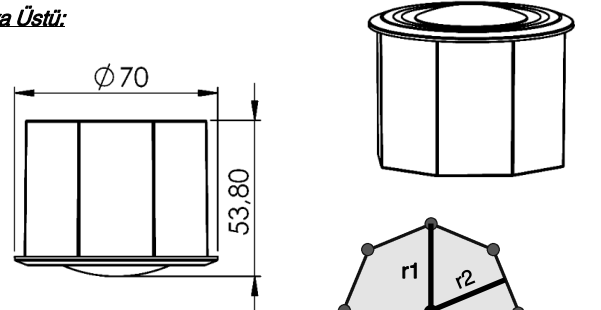

Bağlantı kutusu için metal tırnak

Metal Yay

1xAnalog
2xDijital
Giriş

KNX

Programlama
Konnektörü

Buton

Metal Yay

Bağlantı kutusu için metal tırnak

MONTAJLAMA

Cihaz tavanda, sıva altı montaj muhafazası ile sıva altına veya opsiyonel olarak temin edilebilen sıva üstü kasa sıva üstüne monte edilebilir.

Sıva Altı Montajlama

- Öncelikle sıva altı montaj yapılacak tavan yüzeyinde sensör montajına uygun büyüklükte bir montaj yuvası açılır.
- Daha sonra KNX kablosu ve varsa dijital/analog giriş kabloları sensör üzerindeki ilgili konektörlere bağlanır.
- Sensör üzerindeki 2 metal yay gerilir ve ardından sensör tavandaki deliğe takılır. Böylece montaj işlemi bitmiş olur.

Sıva Üstü Montajlama

- Öncelikle tavan yüzeyinde kablolar için uygun büyüklükte bir delik açılır.
- İkinci olarak sensörün yerleştirileceği yüzey bağlantısı için sekizgen montaj aparatı tavana vidalanır.
- Daha sonra KNX kablosu ve varsa dijital/analog giriş kabloları sensör üzerindeki ilgili konektörlere bağlanır.
- Sensör muhafazasındaki 2 metal yay çıkarılır ve ardından metal tırnaklar sensör muhafazasına takılır. Ardından sensör bağlantı kutusuna monte edilir. Böylece montaj işlemi tamamlanmış olur.

KALIBRASYON

ETS parametreleri ve nesnelere yardımcıyla sensör için bir parlaklık ayarı gerçekleştirme seçeneği vardır.

Kalibrasyon Prosedürü

- Yeterli gün ışığında (> 1/2 * ayar noktası) ölçümü gerçekleştirin.
- Işık kaynağını kapatın.
- Bir lüksmetre ile belirli bir yerde parlaklık ölçümünü gerçekleştirin. Örneğin, tavandaki sensöre doğru olacak bir açıyla ilgili ortamda lüksmetre ile durulmalı ve ışık sabit olmaya yakın olana kadar beklenmelidir. Ölçümden sonra mümkün olan en kısa sürede ETS aracılığıyla parlaklık kalibrasyon nesnesini kullanarak ilgili lux değeri cihaza gönderilmelidir.

ÖNEMLİ NOTLAR

- Elektrik tesisatlarının planlanması ve kurulumu için ilgili ülkenin yürürlükte olan ilgili spesifikasyonlarına, yönergelerine ve yönetmeliklerine uyulmalıdır.
- Programlama: Ürün yalnızca ETS yazılımı ile programlanabilir.
- Voltaj: Giriş voltajı 21-30 V DC'dir.
- Montaj Konumu: Klima havalandırma deliğinin yakınına kurulmasını önlemek ve ısı kaynağından uzak olmak için iç mekana monte edilir.

Multi-Präsenz-Detektor



Produktcode	ITR415-0XXX
Sensorik	Passives Infrarot
Stromversorgung	KNX-Stromversorgung
Installationsumgebung	Drinnen
Derzeitiger Verbrauch	5 mA
Helligkeitserkennung	1-1200 lux
Eingaben	3 Eingaben 2 x Digitaleingang und 1 x Digitaleingang/Analogeingang
Maximale Luftfeuchtigkeit	% 90 RH
Verschmutzungsgrad	2
Art des Schutzes	Unterputzmontage: IP 20 Oberflächenmontage: IP 44
Temperaturbereich	Betrieb (-5°C...45°C) Lagerung (-10°C...60°C)
Maße	70 x 41,8 mm (Φ x H)
Farbe	Schwarz und weiß
Zertifizierung	KNX-zertifiziert
Aufbau	Konfiguration mit ETS

BESCHREIBUNG

Der Multi-Präsenz-Detektor ist ein multifunktionales Gerät für den Innenbereich.

Verwendungen mit Erkennungsfunktion. Es umfasst 4 unabhängige Präsenzkanäle, die mit der Funktionalität Konstant Lichtschalter und Konstantlichtregler genutzt werden können. Unabhängige Präsenzkanäle können je nach Benutzeranforderungen als automatischer oder halbautomatischer Modus konfiguriert werden. Darüber hinaus unterstützt ITR415-0XXX für eine einfache Nutzung auch Sensorfunktionen ohne Präsenzkanäle. Über einen integrierten Temperatursensor können Temperaturmessungen durchgeführt und Temperaturinformationen an den KNX-Bus gemeldet werden. ITR415-0XXX enthält außerdem 4 unabhängige Logikblöcke, um logische Verknüpfungen herzustellen. Die logischen Blöcke können mit z. B. verknüpft werden.

„AND“, „OR“ und „XOR“-Logik. Die logischen Eingangsbedingungen umfassen Anwesenheit, Helligkeit, Bewegung und äußere Bedingungen. Der Sensor kann auch als Master- oder Slave Modus konfiguriert werden. Die Thermostاتفunktion kann mit einer Innen- oder Außentemperatur genutzt werden.

MODELLE & VARIATIONEN

ITR415-0X₁X₂X₃

X₁: Farbe X₂: Thermostatstatus X₃: Produkttyp

X ₁	Farbe	X ₂	Thermostatstatus
0	Weiß	0	Kein Thermostat
1	Schwarz	1	Thermostat
X ₃	Produkttyp		
1	Mid-Range		
2	Mid-Range Plus		
3	Wide Range Plus		
4	High Bay		
5	High Bay Plus		
6	Microwave		

FUNCTIONS

- ITR415-0XXX unterstützt Anwesenheitserkennung, Helligkeitserkennung, Bewegungserkennung sowie interne und externe Temperaturerkennung.
- Anwesenheitserkennung, basierend auf einem passiven Infrarotsensor oder Mikrowelle, verfügt über 4 unabhängig konfigurierbare Kanäle mit Konstantlichtschalter und Konstantlichtsteuerungsanwendung
- ITR415-0XXX verfügt über 4 Logikfunktionsblöcke und kann im logischen Verhältnis eingestellt werden UND/ODER/XOR. Jeder Block kann 5 Ausgangsobjekte steuern.
- Über 2 digitale Eingänge und 1 digitalen/analogen Eingang können externe Geräte angeschlossen werden
- Schaltsensor, Schalt-/Dimmsensor, Jalousiesensor, Wert-/Zwangsbetrieb Funktion, Szenensteuerung, RGB-Farbsteuerung und HVAC-Modusauswahlsteuerung kann mit Tastern erfolgen, die an die Eingänge angeschlossen werden
- Temperaturmessung über den integrierten Sensor, Analogeingang oder KNX-Temperatursensor mit der Möglichkeit, den Wert bei Änderung und periodisch an den Bus zur Überwachung der Raumtemperatur zu senden.
- Das Gerät integriert auch den „Virtuellen Kartenhalter“; das Anwendungsgebiet ist das Hotelzimmer: Über einen Magnetsensor, der an der Tür installiert und mit einem digitalen Eingang verbunden ist, werden genaue Anwesenheitsinformationen verwaltet.
- Der Erfassungsbereich zur Erkennung sitzender, auf sie zu- und übergehender Personen ist unterschiedlich groß. Abhängig von der Montagehöhe ändert sich der Erfassungsbereich des Melders.
- Mit der Funktion des Konstantlichtreglers: Der Melder hält die Helligkeit auf einem konstanten Wert und dimmt das Licht entsprechend der Umgebungshelligkeit auf die entsprechende Intensität
- Die Thermostاتفunktion kann mit einer internen oder externen Temperaturregelung genutzt werden Natur

ERKENNUNGSBEREICH

ITR415-0XX1 - Mid-Range

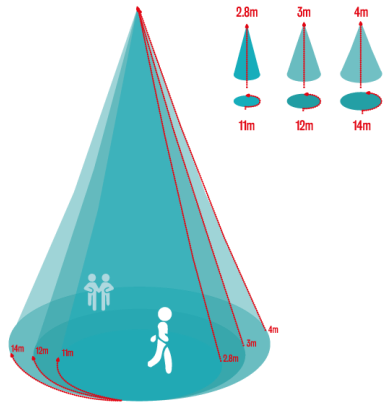

Montagehöhe	Sitzende Aktivität	Auf dem Weg dorthin	Überqueren
2.8 m	5.5 m	6 m	11 m
3 m	6 m	7 m	12 m
4 m	7 m	8 m	14 m

ITR415-0XX2 - Mid-Range Plus

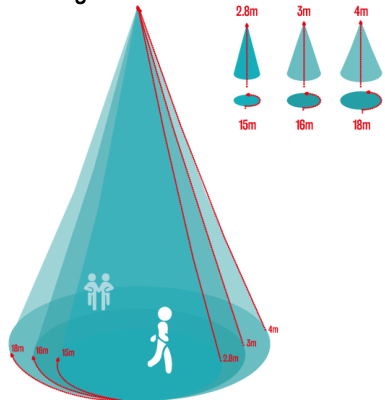

Montagehöhe	Sitzende Aktivität	Auf dem Weg dorthin	Überqueren
2.8 m	6 m	9 m	15 m
3 m	6.5 m	11 m	16 m
4 m	7 m	12 m	18 m

ITR415-0XX3 - Wide-Range

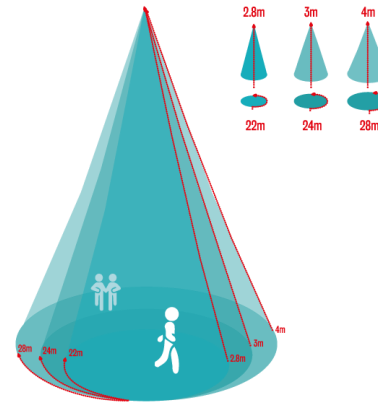

Montagehöhe	Sitzende Aktivität	Auf dem Weg dorthin	Überqueren
2.8 m	6 m	12 m	22 m
3 m	7 m	14 m	24 m
4 m	7.5 m	16 m	28 m

ITR415-0XX6 - Microwave

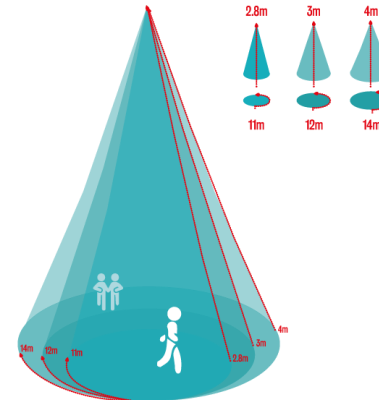

Montagehöhe	Sitzende Aktivität	Auf dem Weg dorthin	Überqueren
2.8 m	5.5 m	6 m	11 m
3 m	6 m	7 m	12 m

ITR415-0XX4 - High Bay

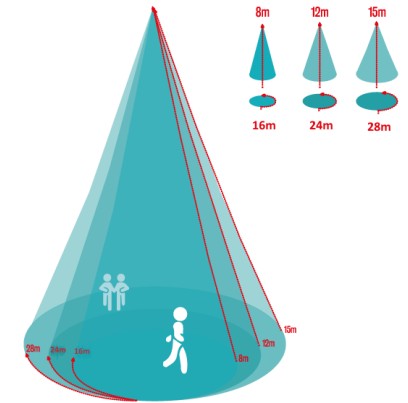

Montagehöhe	Überqueren
4 m	8 m
8 m	16 m
12 m	24 m
15 m	28 m

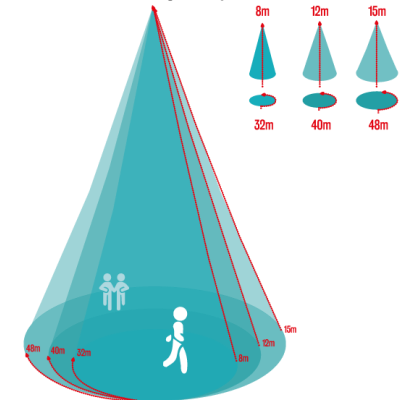

ITR415-0XX5 - High Bay Plus



Montagehöhe	Überqueren
4 m	16 m
8 m	32 m
12 m	40 m
15 m	48 m

NÜTZLICHE INSTALLATIONSTIPPS

Da der Sensor auf Temperaturänderungen reagiert, sollten folgende Bedingungen vermieden werden:

-  Vermeiden Sie es, den Sensor auf Objekte zu richten, die im Wind schwanken könnten, wie z. B. Vorhänge, hohe Pflanzen, Miniaturen usw.
-  Vermeiden Sie es, den Sensor auf Objekte zu richten, deren Oberflächen stark reflektieren, wie z. B. Spiegel, Glas, Pool usw.
-  Der Sensor sollte entfernt von Wärmequellen wie Klimaanlage, Lichtern, Heizungsöffnungen usw. montiert werden.

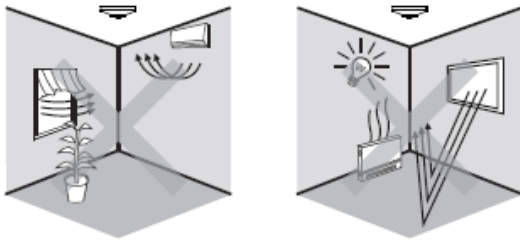

ZUSÄTZLICHER TEMPERATURFÜHLER



In der nachstehenden Tabelle sind die mit unserem Produkt kompatiblen Temperaturfühler aufgeführt. Der Temperaturfühler ist nicht im Lieferumfang des Produkts enthalten und muss vom Kunden separat bestellt werden.

Produkt-Code	HM001718
Beschreibung	Thermistor NTC 10K 5%
Kabel Querschnitt	24 AWG
Länge des Kabels	1.5 m
Pin-Anzahl	2

TECHNISCHE ZEICHNUNGEN

Nachfolgend finden Sie technische Zeichnungen und Abmessungen für Unterputz- und Aufputz Sensormodelle. Alle Maßangaben für technische Zeichnungen erfolgen in Millimeter.

Unterputzmontage

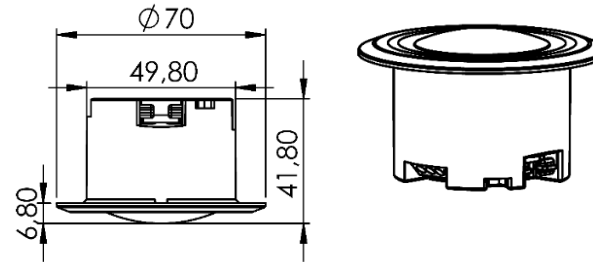

Aufputzmontage:

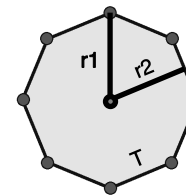
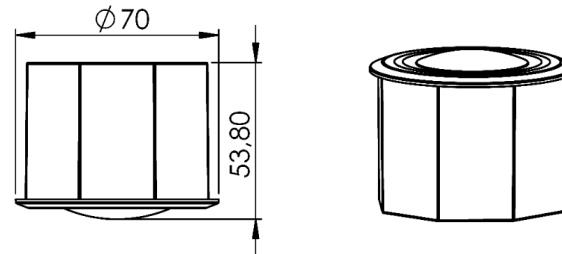

r1 : 31,54

r2 : 34,14

T : 26,13

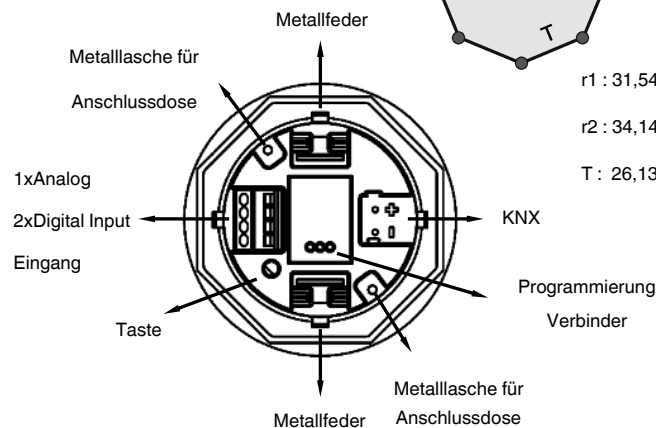

MONTAGE

Die Montage des Gerätes kann entweder in der Decke mittels Unterputzgehäuse oder an der Decke mittels optional erhältlichlicher Aufputzdose erfolgen

Unterputzmontageprozess

- Zunächst wird zur flächenbündigen Montage ein Langloch geeigneter Größe für die Sensormontage auf der Deckenfläche geöffnet.
- Anschließend werden KNX-Kabel und ggf. Eingangskabel an die entsprechenden Anschlüsse am Sensor angeschlossen.
- Die 2 Metallfedern am Sensor werden gespannt und anschließend wird der Sensor am Loch an der Decke befestigt. Damit ist der Montagevorgang abgeschlossen.

Oberflächenmontageprozess

- Zunächst wird an der Deckenfläche ein Loch geeigneter Größe für Kabel geöffnet.
- Zweitens die achteckige Anschlussdose, in der der Sensor platziert wird, wird an die Decke geschraubt.
- Anschließend werden KNX-Kabel und ggf. Eingangskabel an den entsprechenden Anschluss angeschlossen.
- Die 2 Metallfedern am Sensorgehäuse werden entfernt und anschließend werden die Metalllaschen am Sensorgehäuse befestigt. Anschließend wird der Sensor an der Anschlussdose montiert. Damit ist der Montagevorgang abgeschlossen.

KALIBRIERUNG

Es besteht die Möglichkeit, über die Anwendung Helligkeitserfassung mit Hilfe der ETS-Parameter und -Objekte eine Helligkeitsanpassung des Sensors durchzuführen.

Kalibrierungsverfahren

- Führen Sie die Messung bei ausreichend Tageslicht (> 1/2 * Sollwert) durch.
- Schalten Sie die Lichtquelle aus.
- Führen Sie die Helligkeitsmessung an einem definierten Ort mit einem Luxmeter durch. Legen Sie sich zum Beispiel am Arbeitsplatz mit Blick zur Decke hin und warten Sie, bis das Licht nahezu konstant ist. Senden Sie den Wert schnellstmöglich nach der Messung über das Helligkeitskalibrierungsobjekt per ETS an das Gerät.

WICHTIGE NOTIZEN

- Für die Planung und den Bau elektrischer Anlagen Es sind die entsprechenden Vorgaben, Richtlinien und Vorschriften des jeweiligen Landes einzuhalten
- Spezielle Programmierung: ITR415-0XXX ist für die professionelle KNX-Installation konzipiert. Es kann nur mit der ETS-Software programmiert werden
- Spannung: Die Eingangsspannung soll 21-30 V DC betragen
- Montageort: Wird im Innenbereich installiert, um die Installation in der Nähe der Lüftungsöffnung der Klimaanlage zu vermeiden und von der Wärmequelle entfernt zu sein.