

Conventional Logic Sensor



Product Code	ITR415-2XXX
Sensor Technology	Passive Infrared
Power Supply	9-15 V DC Power Supply
Installation environment	Indoor
Current Consumption	30 mA (12 V DC)
Maximum Air Humidity	% 90 RH
Brightness Detection	1-1200 lux
Type of Protection	Flush Mount : IP 20 - II Surface Mount : IP 44 - II
Temperature Range	Operation (-5°C...45°C) Storage (-10°C...60°C)
Dimensions	70 x 41,8 mm (Φ x H)
Colour	Black and White

DESCRIPTION

Conventional Logic Sensor is a multi-functional device suitable for indoor usages with detection capability. It also offers special use for hotel rooms and provides the possibility of use with virtual card function. The device also integrates “Virtual Card Holder”; The application area is the hotel room: through a magnetic sensor mounted on the door and connected to a digital input, accurate presence information is managed. In this way, when it detects that there is no customer in the hotel room, it cuts off the energy of the room and saves energy. For general use areas, it can cut off the energy of the lighting units that control the relevant area by changing the status of the relay only when presence is detected.

MODELS & VARIATIONS

ITR 415 - 2 X₁ X₂ X₃

X₁: Colour X₂: Reserved X₃: Product Type

X ₁	Colour
0	White
1	Black
X ₃	Product Type
1	Mid-Range
2	Mid-Range Plus
3	Wide Range Plus
4	High Bay
5	High Bay Plus

CONFIGURATION

- The device can operate in two distinct modes. The first mode is customized for hotel rooms, involving a combination of a presence sensor and a door contact input (Mode 1). The second mode utilizes only the presence sensor (Mode 2).

- To change the operational mode of the device, users must press and hold the configuration button located on the rear panel for a duration of 3 to 15 seconds. The activation of the new mode is visually confirmed through the illumination of red or blue LEDs: red LED for Mode 1 and blue LED for Mode 2 transitions.
- The sensor's standby time can be adjusted to 1 minute, 5 minutes, 10 minutes, 15 minutes, or 20 minutes by users. There are two methods to set the standby time. The first method involves pressing the configuration button for less than 3 seconds. The second method requires exposing the sensor to high light (at least 900 lux greater than the ambient light intensity) for a minimum of 2 seconds, followed by withdrawing the light source within 4 seconds. This process sets the standby time, which is indicated by the LEDs lighting up to the respective level. The pattern and color of the LED illumination vary depending on the Mode and contact type.
- If Mode 1 is to be used, the contact type (Normally Open/Normally Close) must be determined by pressing the configuration button for a minimum duration of 15 seconds. Following this period, the contact type is switched. The device is set to Normally Close if it operates with blinking and to Normally Open if it operates without blinking.
- Upon each power-up and parameter change, the device activates LEDs according to its current configuration settings.
- The default parameters of the device are set to Mode 2 (using only the presence sensor) with a standby time of 5 minutes.

	Working Mode	Standby Duration	Contact Type
Change	3 - 15 sec	0 - 3 sec	Min 15 Sec
		2 - 4 sec	
Learn	Mode 2	1 time ON/OFF: 1 Minute 2 times ON/OFF: 5 Minute 3 times ON/OFF: 10 Minute 4 times ON/OFF: 15 Minute 5 times ON/OFF: 20 Minute	Normally Open: No Blink Normally Close: Blink
	Mode 1		

DETECTION RANGE

ITR415-0XX1 - Mid-Range

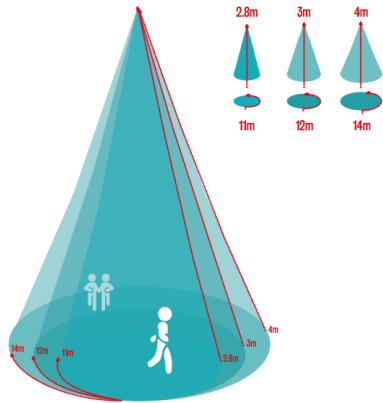

Mounting Height	Seated Activity	Walking Towards	Walking Across
2.8 m	5.5 m	6 m	11 m
3 m	6 m	7 m	12 m
4 m	7 m	8 m	14 m

ITR415-0XX2 - Mid-Range Plus

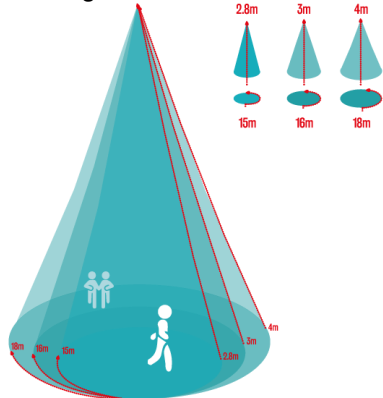

Mounting Height	Seated Activity	Walking Towards	Walking Across
2.8 m	6 m	9 m	15 m
3 m	6.5 m	11 m	16 m
4 m	7 m	12 m	18 m

ITR415-0XX3 - Wide-Range

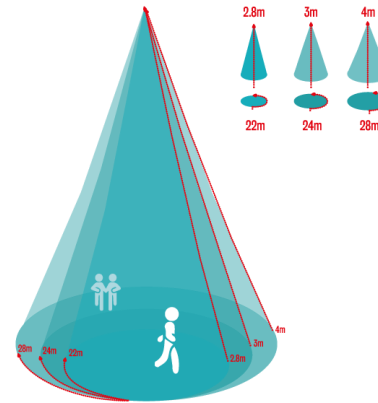

Mounting Height	Seated Activity	Walking Towards	Walking Across
2.8 m	6 m	12 m	22 m
3 m	7 m	14 m	24 m
4 m	7.5 m	16 m	28 m

ITR415-0XX4 - High Bay

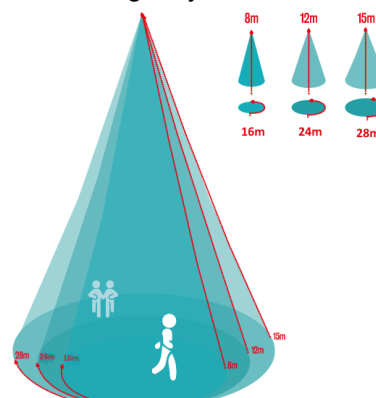

Mounting Height	Walking Across
4 m	8 m
8 m	16 m
12 m	24 m
15 m	28 m

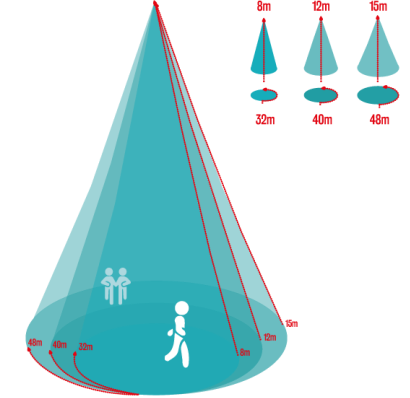

ITR415-0XX5 - High Bay Plus



Mounting Height	Walking Across
4 m	16 m
8 m	32 m
12 m	40 m
15 m	48 m

USEFUL INSTALLATION TIPS

The following conditions should be avoided:

-  Avoid targeting the sensor toward the objects which may be swayed in the wind, such as curtain, tall plants, miniature etc.
-  Avoid targeting the sensor toward the objects whose surfaces are highly reflective, such as mirror, glass and pool, etc.
-  The sensor should be mounted away from heat sources such as air conditioning, lights, heating vents etc.

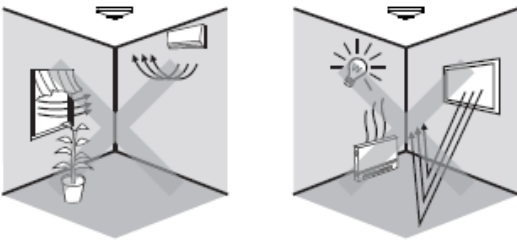

IMPORTANT NOTES

- For planning and construction of electric installations the appropriate specifications, guidelines and regulations in force of the respective country have to be complied.
- Cable Connections: Ensure making correct connections for wires.
- Voltage: The input voltage shall be 9-15 V DC.
- Mounting Location: Installed indoors, to avoid installation near the air-conditioner vent, and be away from the heat source.
- The tightening torque shall not exceed 0.2 Nm.
- Avoid contact with liquids and corrosive gases.

TECHNICAL DRAWINGS

Technical drawings and dimensions for flush mounted and surface mounted sensor models are given below. All dimensions specified for technical drawings are in millimeters.

Flush Mounted:

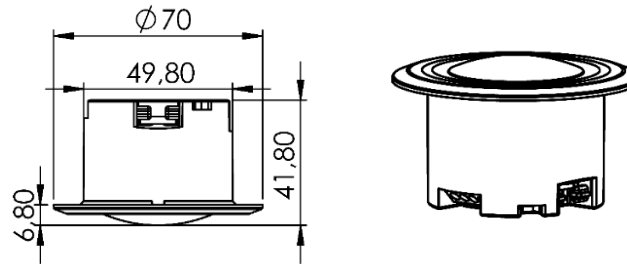

Surface Mounted:

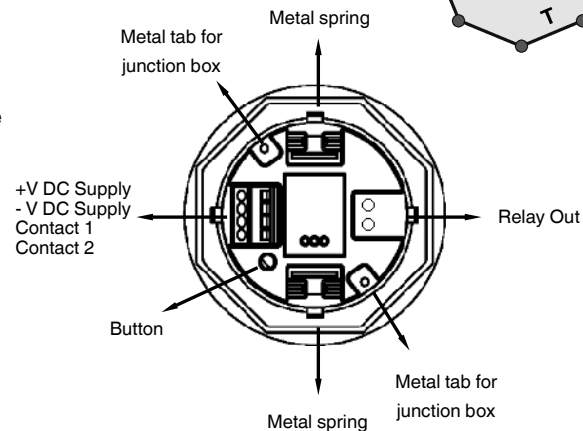
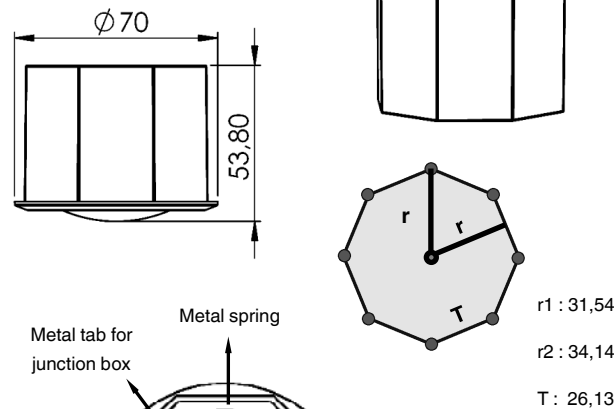

MOUNTING

The device can be mounted either in the ceiling via flush mounting housing or on the ceiling via the optionally available surface-mounted box.

Flush Mount Process:

- First, a slot hole of suitable size for sensor mounting is opened on the ceiling surface to be flush mounted.
- Then, power cable and input cable, if any, are connected to the relevant connectors on the sensor.
- The 2 metal springs on the sensor are stretched and then the sensor is attached to the hole on the ceiling. Thus, mounting process is finished.

Surface Mount Process:

- First, a hole of suitable size for cables is opened on the ceiling surface.
- Second, the octagonal surface junction box where the sensor will be placed is screwed to the ceiling.
- Then, power cable and input cable, if any, are connected to the relevant connectors on the sensor.
- The 2 metal springs on the sensor housing are removed and then the metal tabs are attached to the sensor housing. Then, the sensor is mounted to junction box. Thus, mounting process is completed.

Konvansiyonel Lojik Sensör



Ürün Kodu	ITR415-2XXX
Sensör Teknolojisi	Pasif Kızılötesi
Güç Kaynağı	9 –15 V DC Güç Kaynağı
Kurulum Ortamı	İç Mekan
Akım Tüketimi	30 mA (12 V DC)
Maksimum Nem Oranı	% 90 RH
Parlaklık Aralığı	1-1200 lux
Koruma Seviyesi	Sıva Altı : IP 20 - II Sıva Üstü : IP 44 - II
Sıcaklık Aralığı	Çalışma (-5°C...45°C) Depolama (-10°C...60°C)
Boyutlar	70 × 41,8 mm (Φ x H)
Renk	Siyah ve Beyaz

AÇIKLAMA

Konvansiyonel Lojik Sensörü, iç mekan kullanıcıları için uygun geniş aralık algılama özelliğine sahip çok işlevli bir cihazdır. Otel odalarına özel olarak da kullanım sunan ve sanal kart fonksiyonu ile kullanım imkanı da sağlıyor. Cihaz ayrıca “Sanal Kart Sahibini” entegre eder; uygulama alanı otel odasıdır: kapıya monte edilen ve dijital bir girişe bağlanan bir manyetik sensör aracılığıyla, doğru varlık bilgisi yönetilir. Bu şekilde otel odasında bir müşteri olmadığını algıladığı zaman odanın enerjisini keserek enerji tasarrufunu sağlar. Genel amaçlı kullanım alanları için de sadece varlık algılandığı zaman rölenin durumunu değiştirerek ilgili alanı kontrol eden aydınlatma birimlerinin enerjisini kesebilir.

MODELLER & VARYASYONLAR

ITR 4 1 5 - 2 X₁ X₂ X₃X₁: RenkX₂: RezerveX₃: Ürün Tipi

X ₁	Renk
0	Beyaz
1	Siyah
X ₃	Ürün Tipi
1	Mid-Range
2	Mid-Range Plus
3	Wide Range Plus
4	High Bay
5	High Bay Plus

KONFIGÜRASYON

- Cihaz, iki farklı çalışma modunda kullanılabilir. Birincisi, otel odaları için özelleştirilmiş bir moddur. Bu modda, varlık sensörü ve kapı kontak girişi birlikte çalışır (Mod 1). Diğer çalışma modu ise yalnızca varlık sensörünün kullanıldığı moddur (Mod 2).

- Cihazın çalışma modunu değiştirmek için, kullanıcıların cihazın arka panelinde bulunan konfigürasyon düğmesine 3 ila 15 saniye arasında basılı tutmaları gerekmektedir. Cihazın yeni modu başarıyla etkinleştirildiğinde, kullanıcılar bunu kırmızı veya mavi LED'lerin yanmasıyla görsel olarak teyit edebilirler. Mod 1'e geçiş durumunda, kırmızı LED aktive edilirken, Mod 2'ye geçiş durumunda ise mavi LED kullanılır.
- Sensörün bekleme süresi, kullanıcılar tarafından 1 dakika, 5 dakika, 10 dakika, 15 dakika ve 20 dakika olarak ayarlanabilir. Bekleme süresini ayarlamak için iki farklı yöntem mevcuttur. İlk yöntem, konfigürasyon düğmesine 3 saniyeden daha kısa sürede basmaktır. İkinci yöntem ise sensörü en az 2 saniye boyunca yüksek ışığa maruz bırakıp (ortamdaki ışık şiddetinden 900 lux daha fazla) ardından 4 saniye içinde ışık kaynağını çekmektir. Bu işlem sonucunda bekleme süresi ayarlanmış olur. Cihaz, her bekleme süresi ayarlandığında, ilgili kademeye kadar LED'ler tarafından belirtilir. LED'lerin yanma şekli ve rengi, Mod ve kontak tipine bağlı olarak değişir.
- Eğer Mod1 kullanılacaksa, kontak tipini belirlemek için (Normally Open/ Normally Close) konfigürasyon düğmesine minimum 15 saniye süreyle basılmalıdır. Bu süre sonunda kontak tipi değiştirilir. Kontak tipi fabrika ayarı olarak Normally Close olarak gelir. Cihazın hangi kontak tipinde olduğunu anlamak için ise, eğer blink yaparak çalışıyorsa Normally Close, blink yapmadan çalışıyorsa Normally Open olarak ayarlanmıştır.
- Cihaz her açıldığında ve parametre değiştirildiğinde, bulunduğu konfigürasyona göre LED aktive olur.
- Cihazın varsayılan parametreleri, Mod2'de (sadece varlık sensörü kullanılarak) ve 5 dakikalık bekleme süresi olarak ayarlanmıştır.

	Çalışma Modu	Bekleme Süresi	Kontak Tipi
Değişim	 3 - 15 sec	 0 - 3 sec	 Min 15 Sec
		 2 - 4 sec	
Öğrenme	 Mod 2	1 kez ON/OFF: 1 Dakika 2 kez ON/OFF: 5 Dakika 3 kez ON/OFF: 10 Dakika 4 kez ON/OFF: 15 Dakika 5 kez ON/OFF: 20 Dakika	Normalde Açık: Blink Yok Normalde Kapalı: Blink
	 Mod 1		

ALGILAMA MESAFELERİ

ITR415-0XX1 - Mid-Range

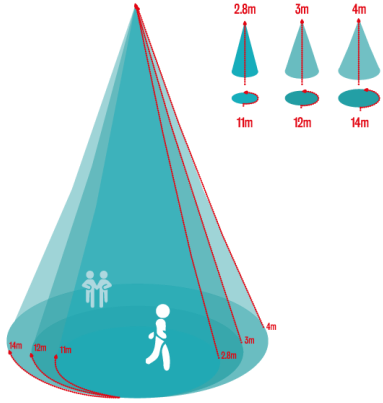

Montaj Yüksekliği	Varlık Algılama	Doğru Yürüme	Teğet Yürüme
2.8 m	5.5 m	6 m	11 m
3 m	6 m	7 m	12 m
4 m	7 m	8 m	14 m

ITR415-0XX2 - Mid-Range Plus

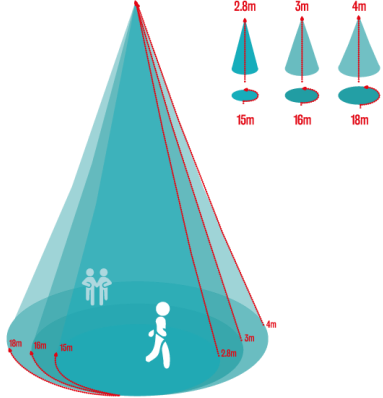

Montaj Yüksekliği	Varlık Algılama	Doğru Yürüme	Teğet Yürüme
2.8 m	6 m	9 m	15 m
3 m	6.5 m	11 m	16 m
4 m	7 m	12 m	18 m

ITR415-0XX3 - Wide-Range

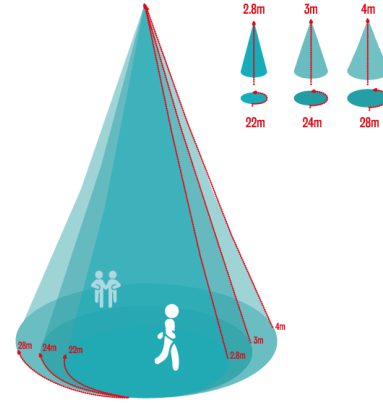

Montaj Yüksekliği	Varlık Algılama	Doğru Yürüme	Teğet Yürüme
2.8 m	6 m	12 m	22 m
3 m	7 m	14 m	24 m
4 m	7.5 m	16 m	28 m

ITR415-0XX4 - High Bay

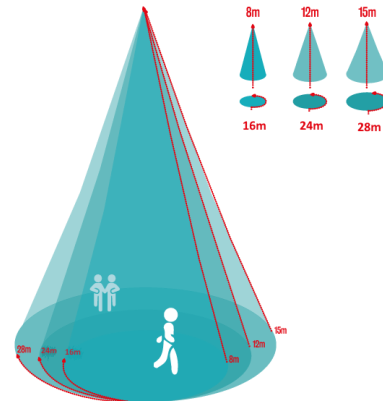

Montaj Yüksekliği	Teğet Yürüme
4 m	8 m
8 m	16 m
12 m	24 m
15 m	28 m

ITR415-0XX5 - High Bay Plus

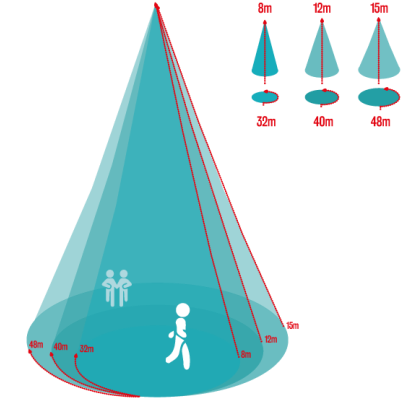

Montaj Yüksekliği	Teğet Yürüme
4 m	16 m
8 m	32 m
12 m	40 m
15 m	48 m

KURULUM ÖNERİLERİ

Aşağıdaki koşullardan kaçınılmalıdır:

- ⚠ Sensörün perde, uzun bitkiler, minyatür vb. gibi rüzgarda sallanabilecek nesnelere doğru hedeflemekten kaçınılmalıdır.
- ⚠ Sensörü, ayna, cam ve havuz gibi yüzeyleri yüksek oranda yansıtıcı olan nesnelere doğru hedeflemekten kaçınılmalıdır.
- ⚠ Sensör, klima, ışıklar, ısıtma delikleri vb. ısı kaynaklarından uzağa monte edilmelidir.

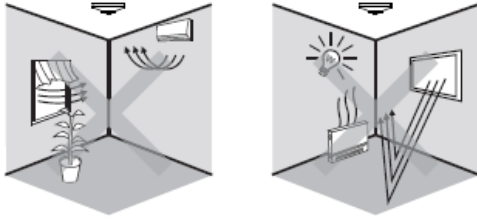

ÖNEMLİ NOTLAR

- Elektrik tesisatlarının planlanması ve kurulumu için ilgili ülkenin yürürlükte olan ilgili spesifikasyonlarına, yönergelerine ve yönetmeliklerine uyulmalıdır.
- Kablo Bağlantıları: doğru bağlantıların yapıldığından emin olunmalıdır.
- Voltaj: Giriş voltajı 9-15 V DC'dir.
- Sıkma torqu 0,2 Nm'yi geçmemelidir.
- Sıvılarla ve aşındırıcı gazlarla temastan kaçının.

TEKNİK ÇİZİMLER

Sıva altı ve sıva üstü sensör modelleri için teknik çizimler ve boyutlar aşağıda verilmiştir. Teknik çizimler için belirtilen tüm ölçüler milimetre cinsindedir.

Sıva Altı:

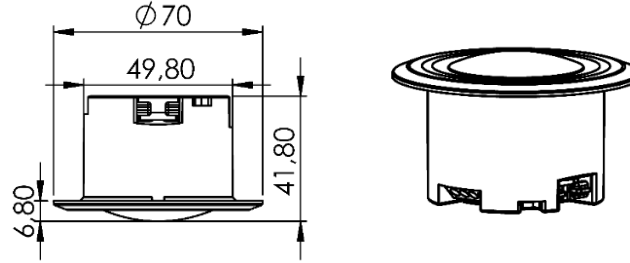

Sıva Üstü:

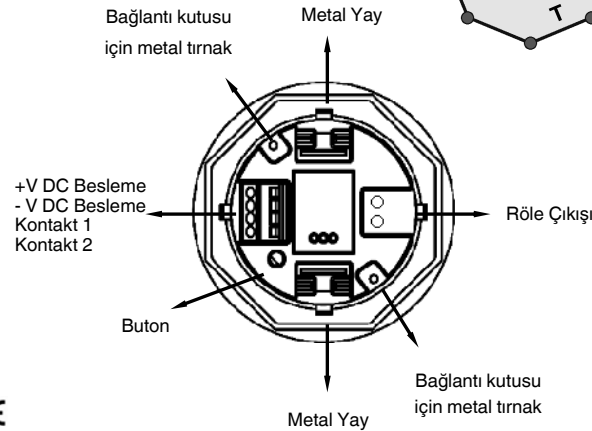
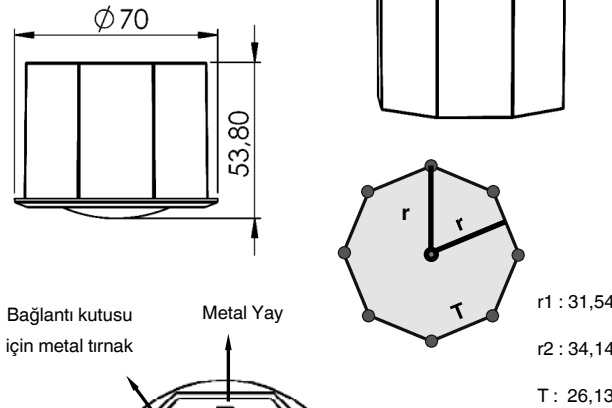

MONTAJLAMA

Cihaz tavanda, sıva altı montaj muhafazası ile sıva altına veya opsiyonel olarak temin edilebilen sıva üstü kasa sıva üstüne monte edilebilir.

Sıva Altı Montajlama

- Öncelikle sıva altı montaj yapılacak tavan yüzeyinde sensör montajına uygun büyüklükte bir montaj yuvası açılır.
- Daha sonra güç kablosu ve varsa giriş kabloları sensör üzerindeki ilgili konektörlere bağlanır.
- Sensör üzerindeki 2 metal yay gerilir ve ardından sensör tavandaki deliğe takılır. Böylece montaj işlemi bitmiş olur.

Sıva Üstü Montajlama

- Öncelikle tavan yüzeyinde kablolar için uygun büyüklükte bir delik açılır.
- İkinci olarak sensörün yerleştirileceği yüzey bağlantısı için sekizgen montaj aparatı tavana vidalanır.
- Daha sonra güç kablosu ve varsa giriş kabloları sensör üzerindeki ilgili konektörlere bağlanır.
- Sensör muhafazasındaki 2 metal yay çıkarılır ve ardından metal tırnaklar sensör muhafazasına takılır. Ardından sensör bağlantı kutusuna monte edilir. Böylece montaj işlemi tamamlanmış olur.

Konventionelle Logiksensoren



Produktcode	ITR415-2XXX
Sensork	Passives Infrarot
Stromversorgung	9-15 V DC Stromversorgung
Installationsumgebung	Drinnen
Derzeitiger Verbrauch	30 mA (12 V DC)
Maximale Luftfeuchtigkeit	% 90 RH
Helligkeitserkennung	1-1200 lux
Art des Schutzes	Unterputzmontage: IP 20 - II Oberflächenmontage: IP 44 - II
Temperaturbereich	Betrieb (-5°C...45°C) Lagerung (-10°C...60°C)
Maße	70 × 41,8 mm (Φ x H)
Farbe	Schwarz und weiß

BESCHREIBUNG

Der Konventionelle Logiksensoren ist ein multifunktionales Gerät, das für die Innenraumnutzung mit Detektionsfähigkeit geeignet ist. Es bietet auch eine spezielle Nutzung für Hotelzimmer und bietet die Möglichkeit der Nutzung mit virtueller Kartenfunktion. Das Gerät integriert zudem einen "Virtuellen Kartenhalter". Der Anwendungsbereich ist das Hotelzimmer: Durch einen an der Tür montierten Magnet Sensor, der an einen digitalen Eingang angeschlossen ist, wird präzise Präsenzinformation verwaltet. Auf diese Weise schaltet es, wenn es erkennt, dass kein Kunde im Hotelzimmer ist, die Energie des Zimmers ab und spart Energie. Für allgemeine Nutzungsbereiche kann es die Energie der Beleuchtungseinheiten, die den relevanten Bereich steuern, durch Ändern des Relaiszustandes nur dann abschalten, wenn eine Präsenz erkannt wird.

MODELLE & VARIATIONEN

ITR 415 - 2 X₁ X₂ X₃

X₁: Farbe X₂: Reserve X₃: Produkttyp

X ₁	Farbe
0	Weiß
1	Schwarz
X ₃	Produkttyp
1	Mid-Range
2	Mid-Range Plus
3	Wide Range Plus
4	High Bay
5	High Bay Plus

KONFIGURATION

- Das Gerät kann in zwei verschiedenen Modi betrieben werden. Der erste Modus ist speziell für Hotelzimmer konzipiert und umfasst die Kombination aus einem Präsenzsensoren und einem Türkontakt-Eingang (Modus 1). Der zweite Modus verwendet nur den Präsenzsensoren (Modus 2).

- Um den Betriebsmodus des Geräts zu ändern, müssen Benutzer die Konfigurationstaste auf der Rückseite für eine Dauer von 3 bis 15 Sekunden drücken und halten. Die Aktivierung des neuen Modus wird visuell durch das Aufleuchten von roten oder blauen LEDs bestätigt: rote LED für den Wechsel zu Modus 1 und blaue LED für den Wechsel zu Modus 2.
- Die Standby-Zeit des Sensors kann von den Benutzern auf 1 Minute, 5 Minuten, 10 Minuten, 15 Minuten oder 20 Minuten eingestellt werden. Es gibt zwei Methoden, um die Standby-Zeit einzustellen. Die erste Methode beinhaltet das Drücken der Konfigurationstaste für weniger als 3 Sekunden. Die zweite Methode erfordert, den Sensor für mindestens 2 Sekunden einem starken Licht (mindestens 900 Lux stärker als die Umgebungshelligkeit) auszusetzen, gefolgt vom Entfernen der Lichtquelle innerhalb von 4 Sekunden. Dieser Vorgang stellt die Standby-Zeit ein, die durch das Aufleuchten der LEDs bis zum entsprechenden Niveau angezeigt wird. Das Muster und die Farbe der LED-Beleuchtung variieren je nach Modus und Kontaktyp.
- Wenn Modus 1 verwendet werden soll, muss der Kontaktyp (Normally Open/ Normally Close) bestimmt werden, indem die Konfigurationstaste für eine Mindstdauer von 15 Sekunden gedrückt wird. Nach diesem Zeitraum wird der Kontaktyp gewechselt. Das Gerät ist auf Normally Close eingestellt, wenn es mit Blinken arbeitet, und auf Normally Open, wenn es ohne Blinken arbeitet.
- Bei jedem Einschalten und bei jeder Parameteränderung aktiviert das Gerät LEDs entsprechend seiner aktuellen Konfigurationseinstellungen.
- Die Standardparameter des Geräts sind auf Modus 2 (nur mit dem Präsenzsensoren) mit einer Standby-Zeit von 5 Minuten eingestellt.

	Working Mode	Arbeits-Modus	Kontakt Typ
Ändern	3 - 15 sek	0 - 3 sek	Min 15 Sek
		2 - 4 sek	
Lernen	Mode 2	1 Mal EIN/AUS: 1 Minute 2 Mal EIN/AUS: 5 Minute 3 Mal EIN/AUS: 10 Minute 4 Mal EIN/AUS: 15 Minute 5 Mal EIN/AUS: 20 Minute	Normalerweise Offen: Kein Blinken Normalerweise geschlossen: Blink
	Mode 1		

ERKENNUNGSBEREICH

ITR415-0XX1 - Mid-Range

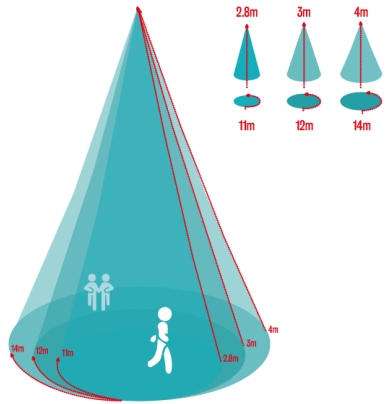

Montagehöhe	Sitzende Aktivität	Auf dem Weg dorthin	Überqueren
2.8 m	5.5 m	6 m	11 m
3 m	6 m	7 m	12 m
4 m	7 m	8 m	14 m

ITR415-0XX2 - Mid-Range Plus

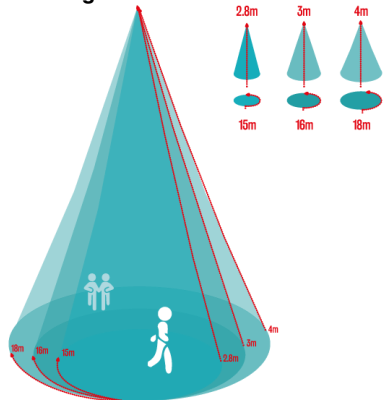

Montagehöhe	Sitzende Aktivität	Auf dem Weg dorthin	Überqueren
2.8 m	6 m	9 m	15 m
3 m	6.5 m	11 m	16 m
4 m	7 m	12 m	18 m

ITR415-0XX3 - Wide-Range

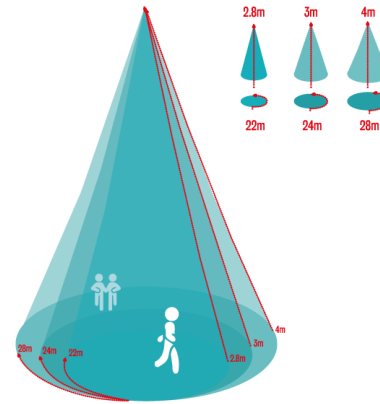

Montagehöhe	Sitzende Aktivität	Auf dem Weg dorthin	Überqueren
2.8 m	6 m	12 m	22 m
3 m	7 m	14 m	24 m
4 m	7.5 m	16 m	28 m

ITR415-0XX4 - High Bay

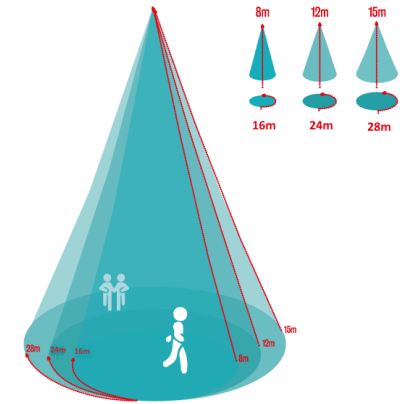

Montagehöhe	Überqueren
4 m	8 m
8 m	16 m
12 m	24 m
15 m	28 m

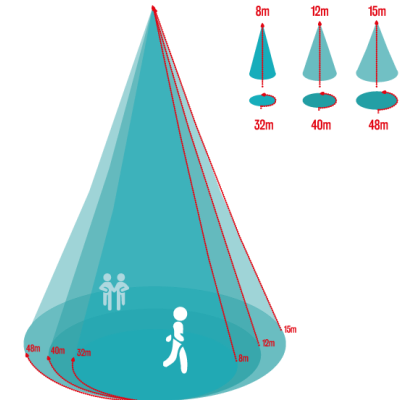

ITR415-0XX5 - High Bay Plus



Montagehöhe	Überqueren
4 m	16 m
8 m	32 m
12 m	40 m
15 m	48 m

NÜTZLICHE INSTALLATIONSTIPPS

Die folgenden Bedingungen müssen vermieden werden:

-  Vermeiden Sie es, den Sensor auf Objekte zu richten, die im Wind schwanken könnten, wie z. B. Vorhänge, hohe Pflanzen, Miniaturen usw.
-  Vermeiden Sie es, den Sensor auf Objekte zu richten, deren Oberflächen stark reflektieren, wie z. B. Spiegel, Glas, Pool usw.
-  Der Sensor sollte entfernt von Wärmequellen wie Klimaanlage, Lichtern, Heizungsöffnungen usw. montiert werden.

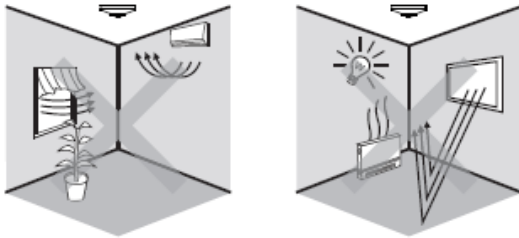

WICHTIGE NOTIZEN

- Für die Planung und den Bau elektrischer Anlagen Es sind die entsprechenden Vorgaben, Richtlinien und Vorschriften des jeweiligen Landes einzuhalten
- Kabelverbindungen: Stellen Sie sicher, dass die richtigen Verbindungen hergestellt werden.
- Spannung: Die Eingangsspannung soll 9-15 V DC betragen
- Montageort: Wird im Innenbereich installiert, um die Installation in der Nähe der Lüftungsöffnung der Klimaanlage zu vermeiden und von der Wärmequelle entfernt zu sein.
- Das Anzugsdrehmoment darf 0,2 Nm nicht überschreiten.
- Vermeiden Sie den Kontakt mit Flüssigkeiten und korrosiven Gasen.

TECHNISCHE ZEICHNUNGEN

Nachfolgend finden Sie technische Zeichnungen und Abmessungen für Unterputz- und Aufputz Sensormodelle. Alle Maßangaben für technische Zeichnungen erfolgen in Millimeter.

Unterputzmontage

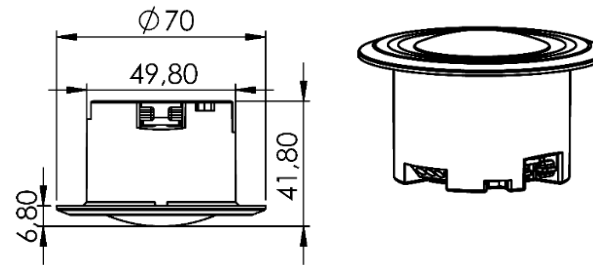

Aufputzmontage:

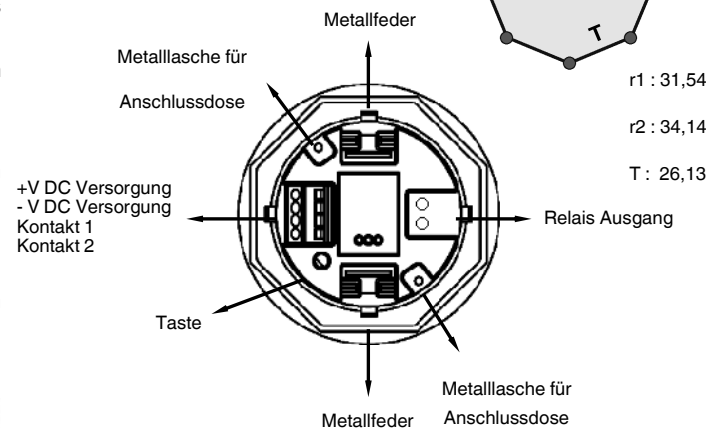
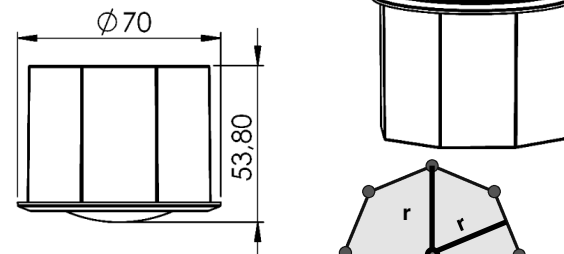

MONTAGE

Die Montage des Gerätes kann entweder in der Decke mittels Unterputzgehäuse oder an der Decke mittels optional erhältlicher Aufputzdose erfolgen

Unterputzmontageprozess

- Zunächst wird zur flächenbündigen Montage ein Langloch geeigneter Größe für die Sensormontage auf der Deckenfläche geöffnet.
- Dann werden das Netzkabel und das Eingangskabel (falls vorhanden) mit den entsprechenden Anschlüssen am Sensor verbunden.
- Die 2 Metallfedern am Sensor werden gespannt und anschließend wird der Sensor am Loch an der Decke befestigt. Damit ist der Montagevorgang abgeschlossen.

Oberflächenmontageprozess

- Zunächst wird an der Deckenfläche ein Loch geeigneter Größe für Kabel geöffnet.
- Zweitens die achteckige Anschlussdose, in der der Sensor platziert wird, wird an die Decke geschraubt.
- Dann werden das Netzkabel und das Eingangskabel (falls vorhanden) mit den entsprechenden Anschlüssen am Sensor verbunden.
- Die 2 Metallfedern am Sensorgehäuse werden entfernt und anschließend werden die Metalllaschen am Sensorgehäuse befestigt. Anschließend wird der Sensor an der Anschlussdose montiert. Damit ist der Montagevorgang abgeschlossen.