

## Daikin Split AC - KNX Gateway

### DESCRIPTION

ITR830-0002 is an air conditioner gateway used for monitoring and controlling all the functioning parameters of Daikin Industries air conditioners via the KNX bus line. Daikin Split AC - KNX Gateway is compatible with models in split types categorized at compatibility list sold by Daikin Industries.

Daikin Split AC - KNX Gateway has an easy installation feature and can be installed inside the own AC indoor unit or a proper location away from the air conditioner, it connects one side directly to the electronic circuit of the AC indoor unit and in the other side directly to the KNX bus.

### DIMENSIONS & CONNECTION DIAGRAM

- All values given in the device dimensions are millimetres.

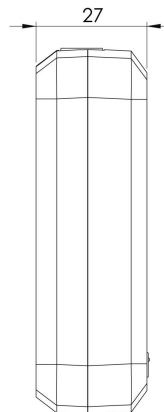
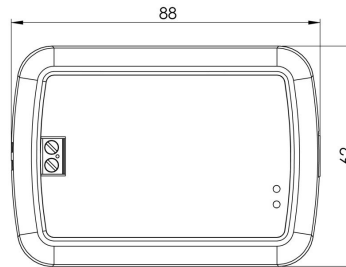

### FUNCTIONS

- ITR830-0002 device provides complete bidirectional integration of Daikin Split air conditioners with KNX bus.
- Includes 4 logical advanced parameters, each logical parameter have up to 4 inputs and can be configured as AND, OR & XOR.
- Includes 8 advanced converter parameters, each converter has four operations math calculations according to the input type.
- Logic and converter parameters can be used for energy savings, configurable scenes, temperature limits etc.
- The Daikin air conditioner unit provides error notifications for errors that may occur in exceptional cases.

<b>Product Code</b>	ITR830-0002
<b>Power Supply</b>	KNX Power Supply
<b>Current Consumption</b>	5 mA
<b>Push Buttons</b>	1 x KNX Programming Button
<b>LED Indicators</b>	1 x KNX Programming LED
<b>Type of Protection</b>	IP 20
<b>Mode of Commissioning</b>	S-Mode
<b>Maximum Air Humidity</b>	< 90 RH
<b>Temperature Range</b>	Operation (-10°C...70°C) Storage (-25°C...100°C)
<b>Colour</b>	Light Grey
<b>Dimensions</b>	88 x 62 x 27 mm (W x H x D)
<b>Configuration</b>	Configuration with ETS

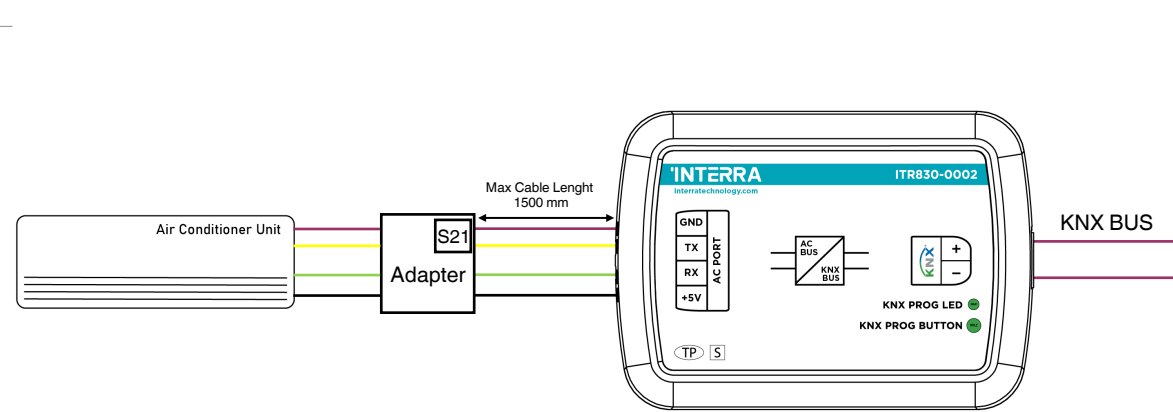
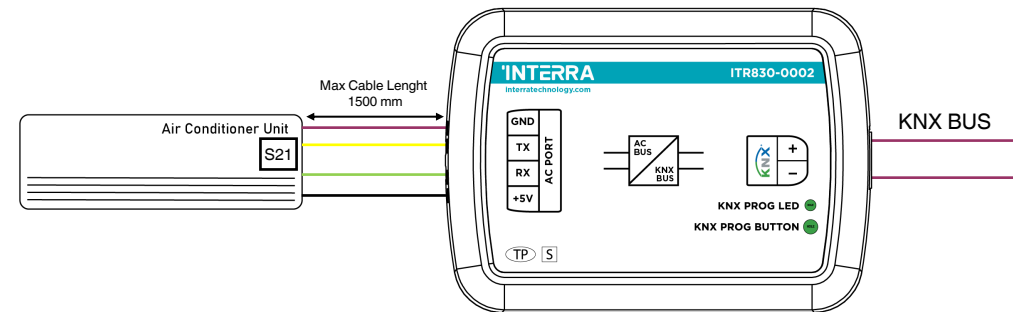

## Daikin Split AC - KNX Arabirimi

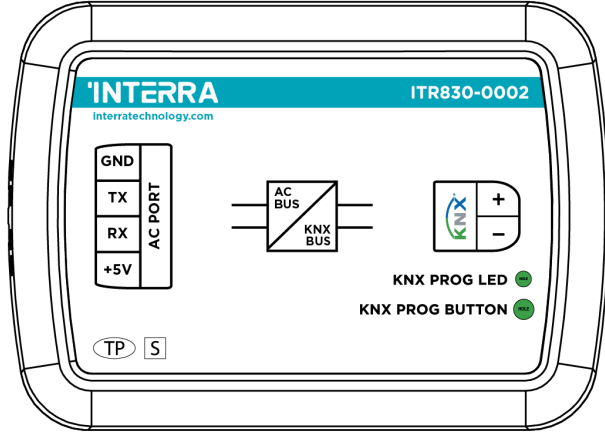

### AÇIKLAMA

ITR830-0002, Daikin Split klima cihazlarının tüm fonksiyon parametrelerini KNX hattı üzerinden izlemek ve kontrol etmek için kullanılan bir klima arabirimidir. Daikin Split AC - KNX arabirimi, Daikin tarafından satılan ve uyumluluk listesinde Split olarak sınıflandırılan modellerle uyumlu olarak çalışmaktadır.

Daikin Split AC - KNX arabirimi kolay kurulum özelliği sayesinde kurulum yapılacak klimanın kendi iç ünitesine veya klimadan uzakta uygun olan bir lokasyona monte edilebilmektedir. Daikin Split AC - KNX arabiriminin bir tarafı doğrudan AC iç ünitenin elektronik devresine diğer tarafı da doğrudan KNX veriyoluna bağlanarak kurulum yapılmaktadır.

### BOYUTLAR & BAĞLANTI DİYAGRAMI

- Cihaz ölçülerinde verilen tüm değerler milimetredir.

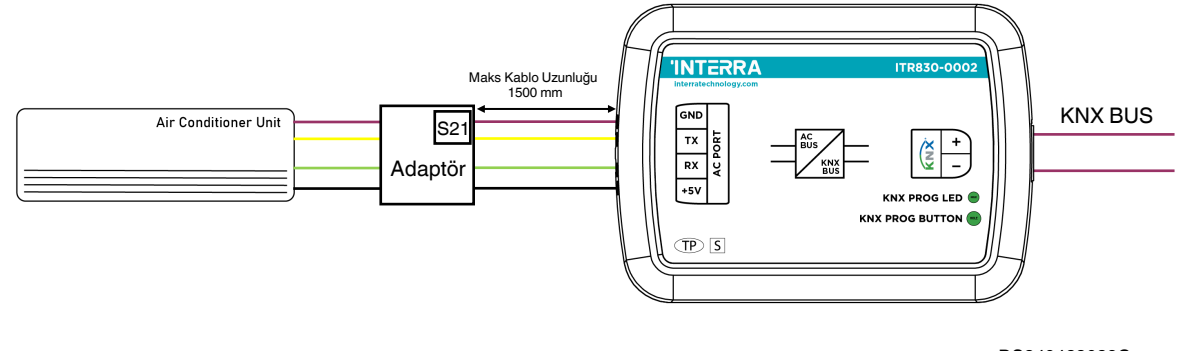
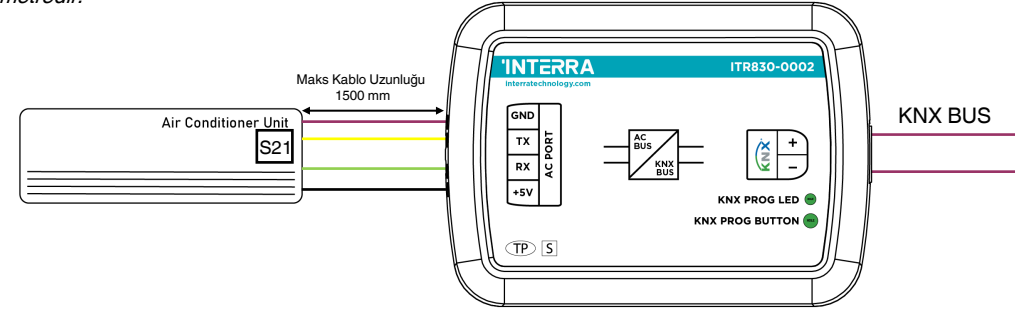
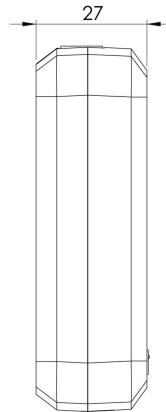
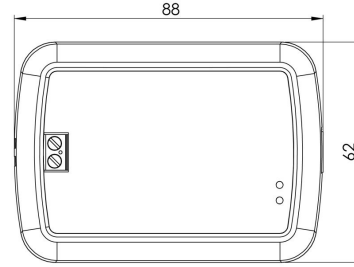

Ürün Kodu	ITR830-0002
Güç Kaynağı	KNX Güç Kaynağı
Akım Tüketimi	5 mA
Basmalı Butonlar	1 x KNX Programlama Butonu
LED Göstergeler	1 x KNX Programlama LED'i
Koruma Tipi	IP 20
İşletme Modu	S Modu
Maksimum Nem Oranı	< 90 RH
Sıcaklık Aralığı	Çalışma (-10°C...70°C) Depolama (-25°C...100°C)
Renk	Açık Gri
Boyutlar	88 x 62 x 27 mm (W x H x D)
Yapılandırma	ETS ile Yapılandırma

## Daikin Split AC - KNX Gateway

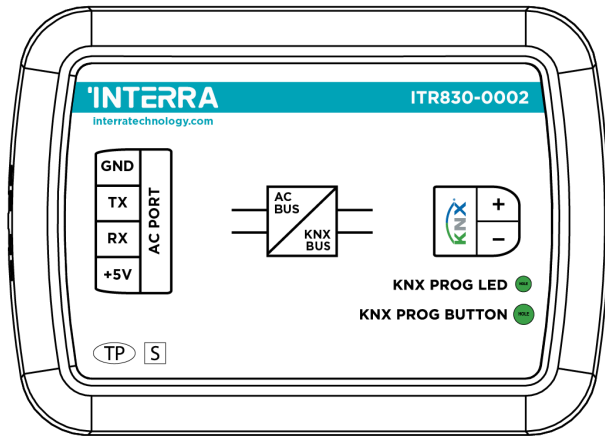

<b>Produktcode</b>	ITR830-0002
<b>Stromversorgung</b>	KNX Stromversorgung
<b>Derzeitiger Verbrauch</b>	5 mA
<b>Drück Knöpfe</b>	1 x KNX Programmier Taste
<b>LED Anzeigen</b>	1 x KNX Programmier LED
<b>Art des Schutzes</b>	IP 20
<b>Art der Inbetriebnahme</b>	S-Modus
<b>Maximale Luftfeuchtigkeit</b>	< 90 RH
<b>Temperaturbereich</b>	Betrieb (-10°C...70°C) Lagerung (-25°C...100°C)
<b>Farbe</b>	Hellgrau
<b>Maße</b>	88 x 62 x 27 mm (B x H x T)
<b>Aufbau</b>	Konfiguration mit ETS

### BESCHREIBUNG

ITR830-0002 ist ein Klimaanlage-Gateway zur Überwachung und Steuerung aller Funktionsparameter von Daikin Industries-Klimaanlagen über die KNX-Busleitung. Das Daikin Split AC – KNX Gateway ist mit Modellen in Split-Typen kompatibel, die in der Kompatibilitätsliste von Daikin Industries kategorisiert sind.

Das Daikin Split AC - KNX Gateway verfügt über eine einfache Installationsfunktion und kann im eigenen AC-Innengerät oder an einem geeigneten Ort entfernt von der Klimaanlage installiert werden. Es verbindet eine Seite direkt mit dem elektronischen Schaltkreis des AC-Innengeräts und die andere Seite direkt an den KNX-Bus.

### ABMESSUNGEN & ANSCHLUSSDIAGRAMM

- Alle in den Geräteabmessungen angegebenen Werte sind Millimeter.

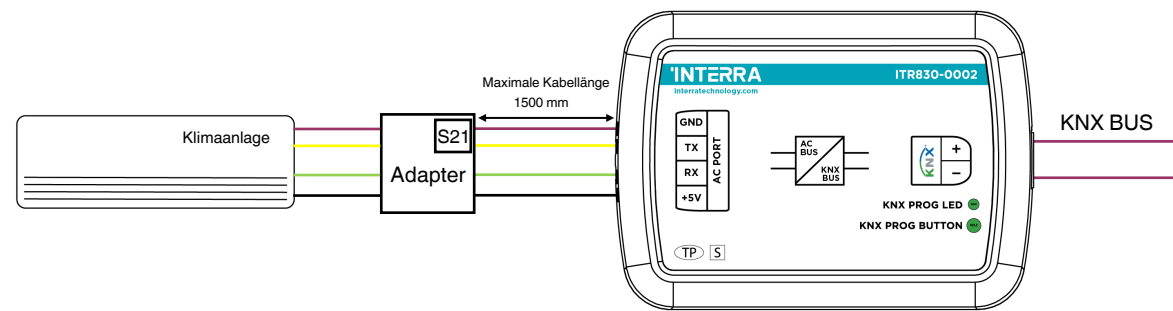
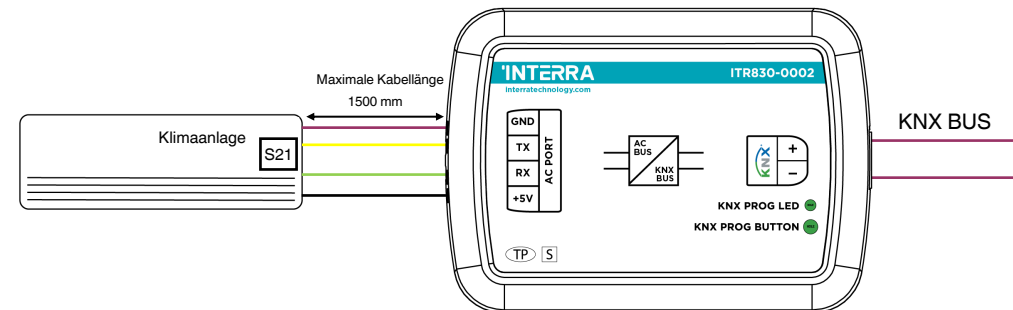
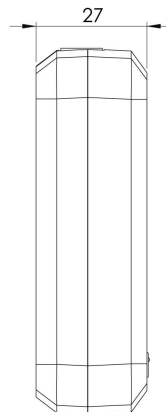
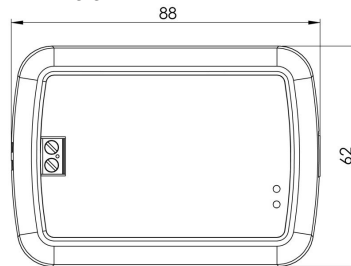

### FUNKTIONEN

- Das Gerät ITR830-0002 bietet eine vollständige bidirektionale Integration von Daikin Split-Klimaanlagen mit KNX-Bus.
- Enthält 4 logische erweiterte Parameter. Jeder logische Parameter verfügt über bis zu 4 Eingänge und kann als UND, ODER und XOR konfiguriert werden.
- Enthält 8 erweiterte Konverterparameter. Jeder Konverter verfügt je nach Eingangstyp über vier mathematische Berechnungsoperationen.
- Logik- und Wandlerparameter können für Energieeinsparungen, konfigurierbare Szenen, Temperaturgrenzen usw. verwendet werden.
- Die Daikin-Klimaanlage stellt Fehlermeldungen für Fehler bereit, die in Ausnahmefällen auftreten können.