

INTERRA

— *Developer of Uniqueness* —

KNX IR Gateway

Product Manual

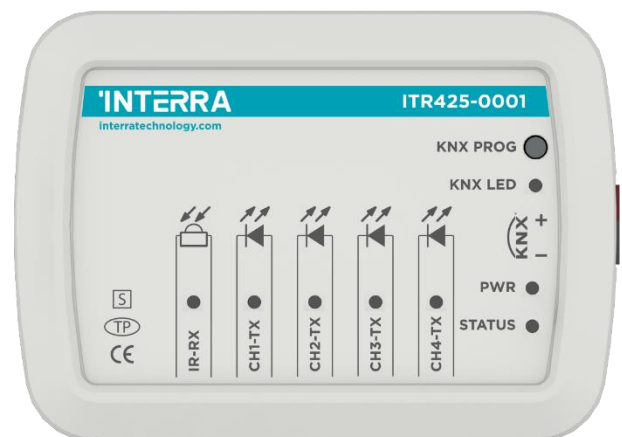

Contents

1. Content of The Document.....	5
2. Product Description	5
2.1. Technical Information.....	6
2.2. Dimensions.....	7
2.3. Functional Descriptions	8
2.4. Connection to The KNX Bus and Programming	9
3. ETS Parameters	10
3.1. General Page.....	10
3.1.1. Parameters List and Button Function List	11
3.2. Infrared Learning.....	12
3.3. Logic	14
3.4. Converter	17
3.5. Scene Sequencer	21
3.6. Scene Sequence Configuration	22
3.6.1 Sequence X Configuration	22
4. ETS Objects List & Descriptions.....	23
4.1. Logic Gate Objects.....	25
4.2. Converter Objects	26
4.3. Sequence Objects	27
4.4. Channel Objects.....	28
IR Gateway Accessories	30

Information in this publication regarding device applications and the like is provided only for your convenience and may be superseded by updates. It is your responsibility to ensure that your application meets your specifications.

INTERRA MAKES NO REPRESENTATIONS OR WARRANTIES OF ANY KIND WHETHER EXPRESS OR IMPLIED, WRITTEN OR ORAL, STATUTORY OR NONSTATUTORY, RELATED TO THE INFORMATION INCLUDING BUT NOT LIMITED TO ITS CONDITION, QUALITY, PERFORMANCE, MERCHANTABILITY OR FITNESS FOR PURPOSE.

Interra disclaims all liability arising from this information and its use. Use of Interra devices in life support and/or safety applications is entirely at the buyer's risk, and the buyer agrees to defend, indemnify and hold harmless Interra from any damages, claims, suits, or expenses resulting from such use. No licenses are implicitly or otherwise conveyed under any Interra intellectual rights.

Trademarks

The Interra name, logo and the Interra ITR425-0001 KNX IR Gateway device are registered trademarks of Interra Technology in Türkiye and other countries.

All other trademarks mentioned herein are property of Interra Technology.

©2024, Interra, Printed in Turkey, All Rights Reserved.



Printed on recycled paper.

TS EN ISO 9001:2008

TO OUR CUSTOMERS

One of our most important aims is to provide you with the best documentation possible to use successfully your Interra products. Focusing on this, we will keep on improving our documentation to better suit your needs. Our publications will be updated as new volumes as soon as changes are introduced.

If you have any questions or comments regarding this publication, do not hesitate to contact us:

E-Mail: info@interratechnology.com

Tel: +90 (216) 326 26 40 Fax: +90 (216) 324 25 03

Most Current Product Manual

To obtain the most up-to-date version of this product manual, please visit our Web site at:

<http://www.interratechnology.com>

You can determine the version of an Interra document by examining its literature number found on the bottom right corner of any page.

The first two letters of the literature are the type of document. The following numbers are the document's creation date and the last letter is the version (e.g., PM181017001A is version A of a product manual created on 17/10/18).

1. Content of The Document

This document contains Interra's ITR425-0001 coded KNX IR Gateway device's electronic and all essential feature information for programming this product. In each subtitle is explained the characteristics of the device are. Modifications of the product and special change requests are only allowed in coordination with product management.

2. Product Description

ITR425-0001 KNX IR Gateway is a multifunctional IR transmitter and it has a lot functions like single mode, repeat mode, sequence mode, receiving mode, logic and converter. The device can learn IR commands from any remote up to 64 channels without external learning device. Also, it has 4 emitting interfaces A, B, C and D. The KNX IR Gateway is used to control electronic devices such as TV, DVD, Air-Conditioner and other devices can be controlled by IR. Interra products are manufactured in accordance with EU standard for EMC, electrical safety compatibility.

2.1. Technical Information

The following table shows the technical information of the Interra KNX IR Gateway.

Product Code	ITR425-0001
Power Supply	KNX Power Supply
Current Consumption	< 15 mA
Power Consumption	< 450 mw
Push Buttons	1 x KNX Programming Button
Transmitting wave frequency	30, 33, 36, 37, 38, 40, 56 kHz
Emitting Distance	7 m
Mode of Commissioning	S-Mode
Type of Protection	IP 20
Temperature Range	Operation (– 5°C ...45 °C) Storage (– 20°C ...60 °C)
Maximum Air Humidity	< 90 RH
Colour	Light Grey
Dimensions	88 × 62 x 27 mm (W x H x D)
Certification	KNX Certified
Configuration	Configuration with ETS

2.2. Dimensions

- All values given in the device dimensions are millimetres.

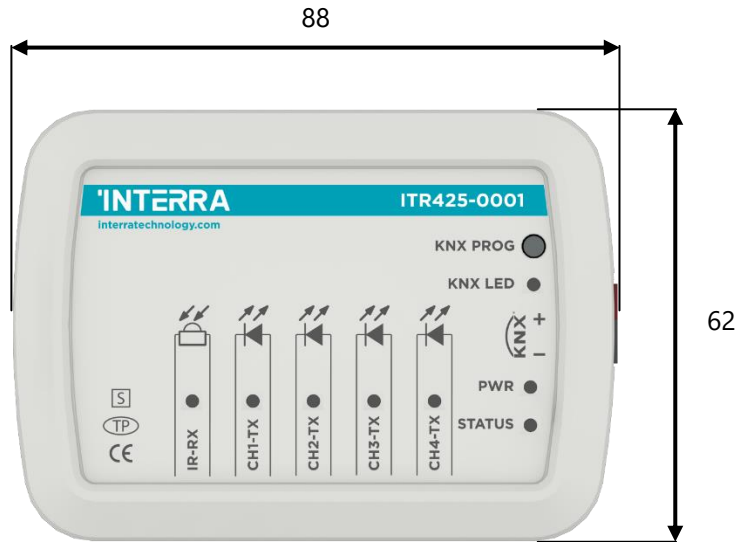

Fig. 1: Dimensions of KNX IR Gateway from the top view

2.3. Functional Descriptions

The prominent features of the KNX IR Gateway are the followings:

- The universal IR codes control AC, TV, DVD and other devices which can be controlled by IR
- KNX Gateway can work between KNX to IR and IR to KNX.
- After learned, obtained and downloaded the infrared codes through “Infrared Learning Page” of device in the ETS database, the KNX IR Gateway can control TV, DVD, air conditioner etc.
- Single mode: System emits one universal IR code and the emitting channel is one channel and multichannel.
- Repeat mode: System emits one universal IR code several times repeatedly and the emitting channel is one channel and multichannel. Automatic switching between operating modes via the weekly program.
- Sequence mode: System emits several universal IR codes sequent at one time.

2.4. Connection to The KNX Bus and Programming

The connection of the KNX bus line is made with the terminal block (black/red socket group) included in delivery and inserted into the slot of housing.

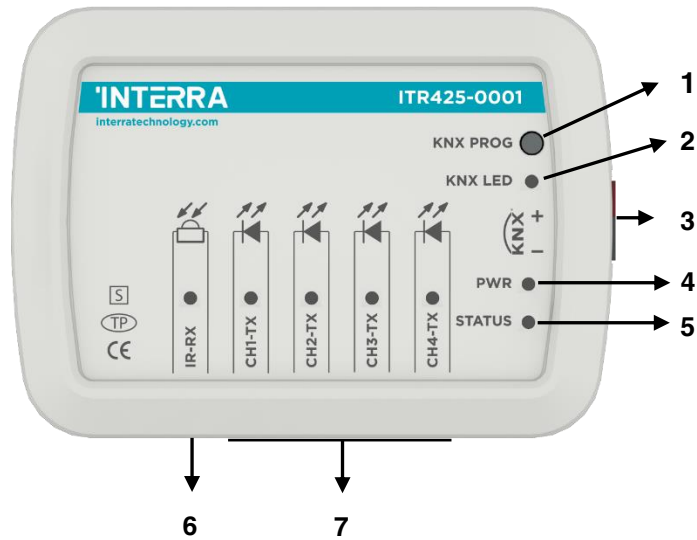

Fig. 2: Diagram of KNX IR Gateway

- 1 KNX Programming Button
- 2 KNX Programming LED
- 3 KNX Bus Connector
- 4 Power LED
- 5 Status LED
- 6 IR-RX LED
- 7 Channel X-TX LEDs

Table 1: Connection Diagram

To enter the programming mode, first press the button in the upper right corner. So red programming LED turn on and the device is ready for programming.

3. ETS Parameters

3.1. General Page

When the KNX IR Gateway is attached to the project from the ETS program, a configuration setting must be made primarily before loading, depending on the model to be programmed. When entering the “GENERAL” in the parameter page, the configuration screen will appear shown above. As previously mentioned, all models can be configured via an ETS file thus the programmers can work flexibly.

Channel	Enabled	Name	Action
Channel 1	<input checked="" type="checkbox"/>	Channel 1	Copy parameters to other channels
Channel 2	<input type="checkbox"/>		Copy parameters to other channels
Channel 3	<input type="checkbox"/>		Copy parameters to other channels
Channel 4	<input type="checkbox"/>		Copy parameters to other channels
Channel 5	<input type="checkbox"/>		Copy parameters to other channels
Channel 6	<input type="checkbox"/>		Copy parameters to other channels
Channel 7	<input type="checkbox"/>		Copy parameters to other channels
Channel 8	<input type="checkbox"/>		Copy parameters to other channels

Fig. 3: General Parameter Configuration Page

3.1.1. Parameters List and Button Function List

PARAMETERS	DESCRIPTION	VALUES
Using status led	This parameter, is used to enable or disable the Status Led.	No Yes
Channel 1...64 Enabled	This parameter is used to enable or disable the related Channel X.	Unchecked Checked
-> Name¹	This parameter is used to type a channel name. The name can be consisting of 40 characters.	40 bytes allowed

¹This parameter is visible when the function "Channels 1...64 Enabled" is set to "Checked".

BUTTONS	DESCRIPTION
Copy parameters to other channels	This parameter is used to copy data from the selected channel to all other channels.

3.2. Infrared Learning

The users can make many settings related to the LCD screen via ETS software. Many features such as screen theme, screen brightness, language selection, screen saver and password screen can be controlled with this tab.

Channel	Read	Learn	Write	Delete	Test	State	Selection	Data
All	Read selected		Write selected	Delete selected			Select	
[1] Channel 1							<input type="checkbox"/>	
[2] Channel 2							<input type="checkbox"/>	
[3] Channel 3							<input type="checkbox"/>	
[4] Channel 4							<input type="checkbox"/>	
[5] Channel 5							<input type="checkbox"/>	

Fig. 4: Infrared Learning Configuration Page

3.2.1. Button Function List

BUTTONS	DESCRIPTION
Selection	This parameter is used to select channels.
Read	This parameter is used to read data from the channel.
Read Selected	This parameter is used to read data from the selected channels.
Learn	This parameter is used to learn the channel. If the teaching is successful, the green LED on the device flashes, if unsuccessful, the red LED flashes.
Write	This parameter is used to write data to the channel.
Write Selected	This parameter is used to write data to the selected channels.
Delete	This parameter is used to delete the data which is defined in the channel.
Delete Selected	This parameter is used to delete the data defined in the selected channels.
Test	This parameter is used to test the data on the channel. If the "Working Style" parameter is selected as "KNX to IR", it sends the defined value in the channel via IR transmitter.
Select	This parameter is used to select all channels.

3.3. Logic

This parameter page is used to make the logical relationships between inputs & output.

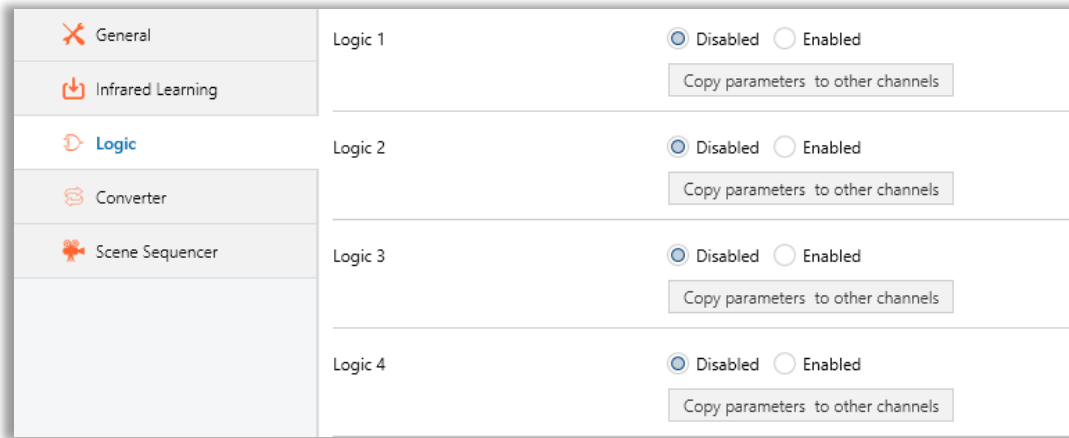

Fig. 5: Logic Configuration Page

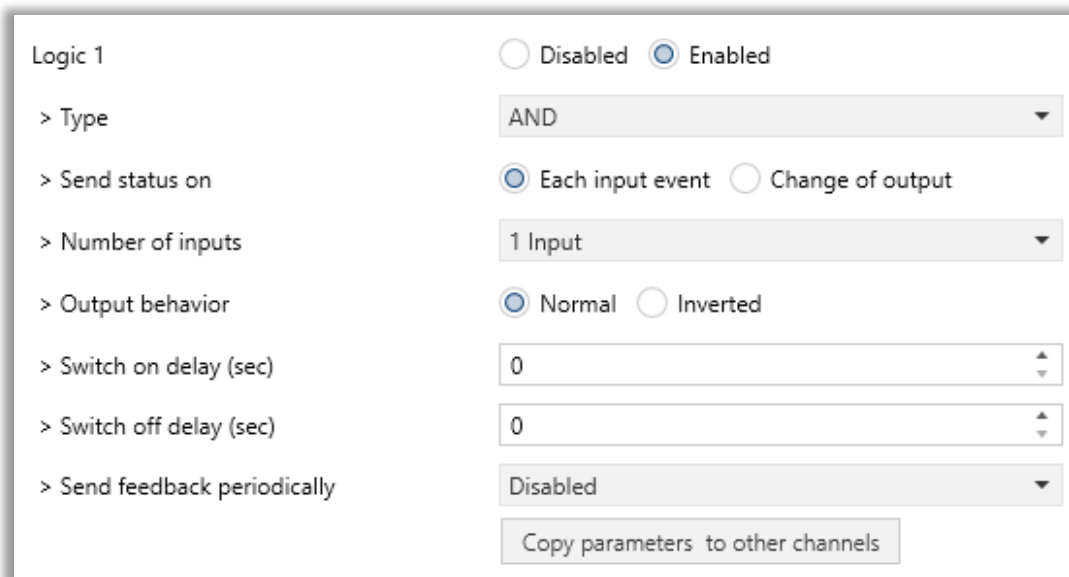

Fig. 6: Logic X Configuration Page

Up to 4 logic gates can be used with the gateway. In addition, each logic gate allows the use of up to 4 inputs. The standard logic operations AND, OR and XOR are available.

The status of the output of logic gates can be shown normally or inverted. This configuration can be applied via the parameter “Output behaviour” and when it is parameterized as inverted, the status of the output is shown inverted.

Through the parameter “Send status on”, the type of feedback can be defined. The gateway allows sending the result of logic gates when the conversely logic output is changed or when one of the logic inputs is modified. Additionally, it is possible to define a cyclic sending of the feedback which permits getting information about the output status periodically.

The logic output can operate with previously configured delays. The logic output takes the values ON and OFF with delays. Depending on the switch delay parameters configuration, it is possible to set an ON delay (TON), and an OFF delay (TOFF) or both at the same time.

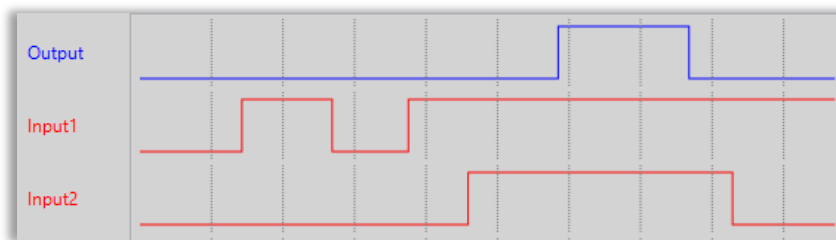

Fig. 7: Logic Gate with Delays

Special Notes



The number of logical gates can be selected up to 4. Since the characteristics of each gate are the same, only Logic 1 is described.

3.3.1. Parameters List

PARAMETERS	DESCRIPTION	VALUES
Logic X	This parameter is used to enable or disable the related logic function gate.	Disabled Enabled
Type	This parameter is used to specify the type of logical gate to be used. There are 3 different logic gate types, AND, OR and XOR. Each logical gate generates a false or true value at its output as a logical association result.	AND OR XOR
Send status on	This parameter is used to specify how the status of the output will be sent. Input Triggered: Output status will be sent when any logic input is received. Output Changed Output status will be sent when the logic output is changed.	Input Triggered Output Changed
Number of inputs	This parameter is used to specify the number of inputs for the logical gate.	1 input 2 inputs 3 inputs 4 inputs
Output behaviour	This parameter defines the behaviour of the logic output. Normal: The status of the output is sent without any modification. Inverted: If the value is true, the false value will be sent as a status value for the output or vice versa.	Normal Inverted
Switch on delay	This parameter is used to set a delay time for output behaviour. The output communication object takes the value TRUE when time reaches the configured time in this parameter.	00:00...04:15 mm:ss
Switch off delay	This parameter is used to set a delay time for output behaviour. The output takes the value FALSE when time reaches the configured time in this parameter.	00:00...04:15 mm:ss
-> Send feedback periodically¹	This parameter determines the Logic X output communication object sending period in minutes.	Disabled, 5 s, 10 s, 30s, 1 m, 5 m, 10 m, 20 m, 30 m, 1 h, 2 h, 3 h, 4h, 5 h, 6 h, 12 h, 24 h

3.4. Converter

The main parameter settings of the Converter Parameter page are made on this page. Various control options for the Converters are enabled from this page.

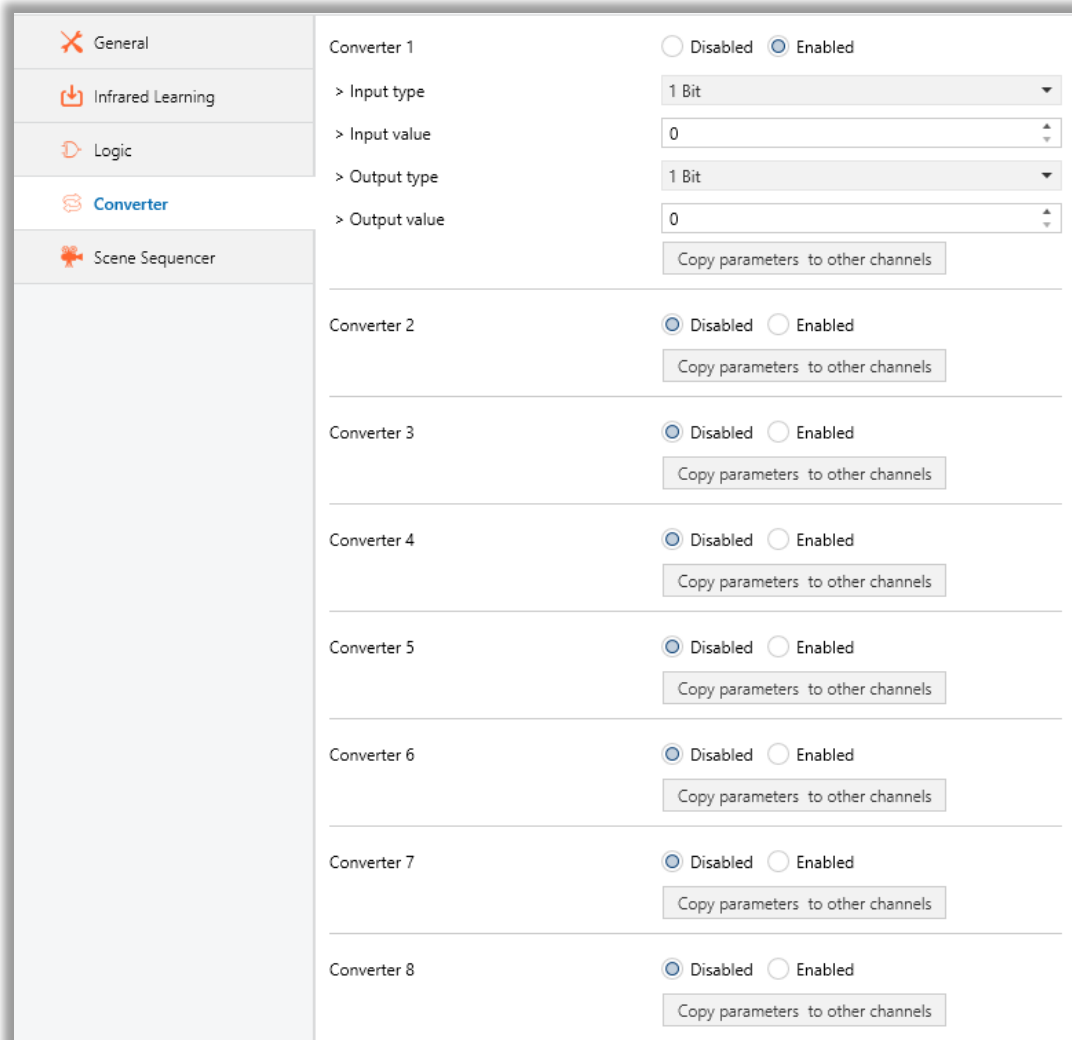

Fig. 8: Converter Configuration Page

Converters are used to convert the output to configured type value depending on the input value. There are 8 different types of data input that can be converted to 4 different data values.

Moreover, if the input is selected as 1 byte or 2 bytes, you can also make the four arithmetical operations (plus, minus, multiply, divide). Some examples are shown below:

<p><u>Ex 1:</u> Input type: 1 byte, 154 Calculation: Plus Calculation value: 7 Output type: 1 byte Output = $154 + 7$ Output = 161</p>	<p><u>Ex 2:</u> Input type: 1 byte, 215 Calculation: Minus Calculation value: 51 Output type: 1 byte Output = $215 - 51$ Output = 164</p>
<p><u>Ex 3:</u> Input type: 2 bytes, 862 Calculation: Multiply Calculation value: 49 Output type: 2 bytes Output = 862×49 Output = 42238</p>	<p><u>Ex 4:</u> Input type: 2 bytes, 46342 Calculation: Divide Calculation value: 986 Output type: 2 bytes Output = $46342 : 986$ Output = 47</p>

3.4.1. Parameters List

PARAMETERS	DESCRIPTION	VALUES
Converter X	This parameter is used to enable the Converter X.	Disabled Enabled
Input type	<p>This parameter is used to specify the type of input value for the converter input. There are 8 different input values for each converter.</p> <p>When the input type is configured as 1-byte or 2-byte logic, the output data type is set as 1 bit. If the input value is non-zero, the output value will be 1. Otherwise, it will be zero.</p>	1 Bit 2 Bits 1 Byte 2 Bytes 1 Byte Logic 2 Bytes Logic 1 Byte Threshold 2 Bytes Threshold
> Input value¹	<p>This parameter is used to set the value of the converter input. Several value types can be selected and these possible values are described below.</p> <p>The input type is 1 Bit: If the input type is selected as 1 bit, values are between 0-1.</p> <p>The input type is 2 Bits: If the input type is selected as 2 bits, values are between 0-3.</p> <p>The input type is 1 Byte: If the input type is selected as 1 byte, values are between 0-255.</p> <p>The input type is 2 Bytes: If the input type is selected as 2 bytes, values are between 0-65535.</p> <p>The input type is 1 Byte logic: If the input type is selected as 1-byte logic, values are between 0-255.</p> <p>The input type is 2 Bytes logic: If the input type is selected as 2-byte logic, values are between 0-65535.</p> <p>The input type is 1 Byte Threshold: If the input type is selected as a 1-byte threshold, values are between 0-255.</p> <p>The input type is 2 Byte Threshold: If the input type is selected as the 2-byte threshold, values are between 0-65535.</p>	0...1 0...3 0...255 0...65535
> Logical Operators²	<p>This parameter is used to perform a mathematical operation with the input value.</p> <p>Disabled: The calculation value is disabled. The input value is converted to output value without a mathematical operation.</p> <p>Plus: The calculation value is summed with the input value and the result is applied to the output value.</p>	Disabled Plus Minus Multiply Divide

	<p>Minus: The calculation value is subtracted from the input value and the result is applied to the output value.</p> <p>Multiply: Input value and calculation value are multiplied and the result is applied to the output value.</p> <p>Divide: The input value is divided by the calculation value and the result is applied to the output value.</p>	
Calculation Value³	This parameter is used to specify the value to be processed along with the input value. This value type is the same as the output value type.	<p>0...255</p> <p>0...65535</p>
Lower Limit⁴	<p>This parameter is used to set the lower limit value of the threshold for the input when the input is configured as 1 byte or 2-byte threshold.</p> <p>⚠ Lower limit value can't be higher than Upper limit value.</p>	<p>0...255</p> <p>0...65535</p>
Higher Limit⁴	<p>This parameter is used to set the higher limit value of the threshold for the input when the input is configured as 1 byte or 2-byte threshold.</p> <p>⚠ Upper limit value can't be lower than Lower limit value.</p>	<p>0...255</p> <p>0...65535</p>
Output type¹	This parameter is used to specify the type of output value for the converter output. There are 4 different output values for each converter.	<p>1 Bit</p> <p>2 Bit</p> <p>1 Byte</p> <p>2 Byte</p>
Output value¹	<p>This parameter is used to set the value of the converter output. Several value types can be selected and these possible values are described below.</p> <p>The output type is 1 Bit: If the input type is selected as 1 bit, values are between 0-1.</p> <p>The output type is 2 Bit: If the input type is selected as 2 bits, values are between 0-3.</p> <p>The output type is 1 Byte: If the input type is selected as 1 byte, values are between 0-255.</p> <p>The output type is 2 Byte: If the input type is selected as 2 bytes, values are between 0-65535.</p>	<p>0...1</p> <p>0...3</p> <p>0...255</p> <p>0...65535</p>

¹ This parameter is visible when the function "Input type" is set to "1 Bit" or "2 Bits" or "1 Byte" or "2 Bytes".

² This parameter is visible when the function "Input type" is set to "1 Byte" or "2 Bytes".

³ This parameter is visible when the function "Logical Operators" is set to "Plus" or "Minus" or "Multiply" or "Divide". If

⁴ This parameter is visible when the function "Input type" is set to "1 Byte Threshold" or "2 Byte Threshold".

3.5. Scene Sequencer

The users can configure the functions page's count and layout. Up to 6 different layouts are available in this section. Up to 8 function pages can be set.

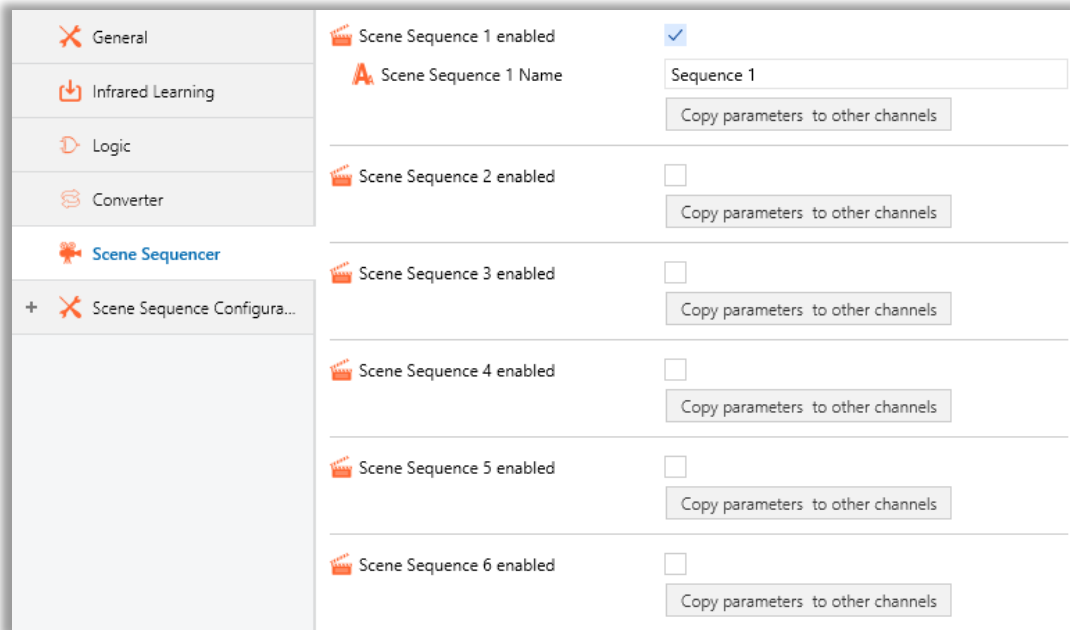

Fig. 9: Scene Sequencer Configuration Page

4.5.1. Parameter List and Button Function List

PARAMETERS	DESCRIPTION	VALUES
Scene Sequence X enabled	This parameter is used to enable the Scene Sequence X.	Unchecked Checked
-> Scene Sequence X Name	This parameter is used to type a Scene Sequence X Name. The name can be consisting of 40 characters.	40 bytes allowed

BUTTONS	DESCRIPTION
Copy parameters to other channels	This parameter is used to copy data from the selected channel to all other channels.

3.6. Scene Sequence Configuration

3.6.1 Sequence X Configuration

Each button is linked to different function such as switch function, multifunction, thermostat control, AC control functions.

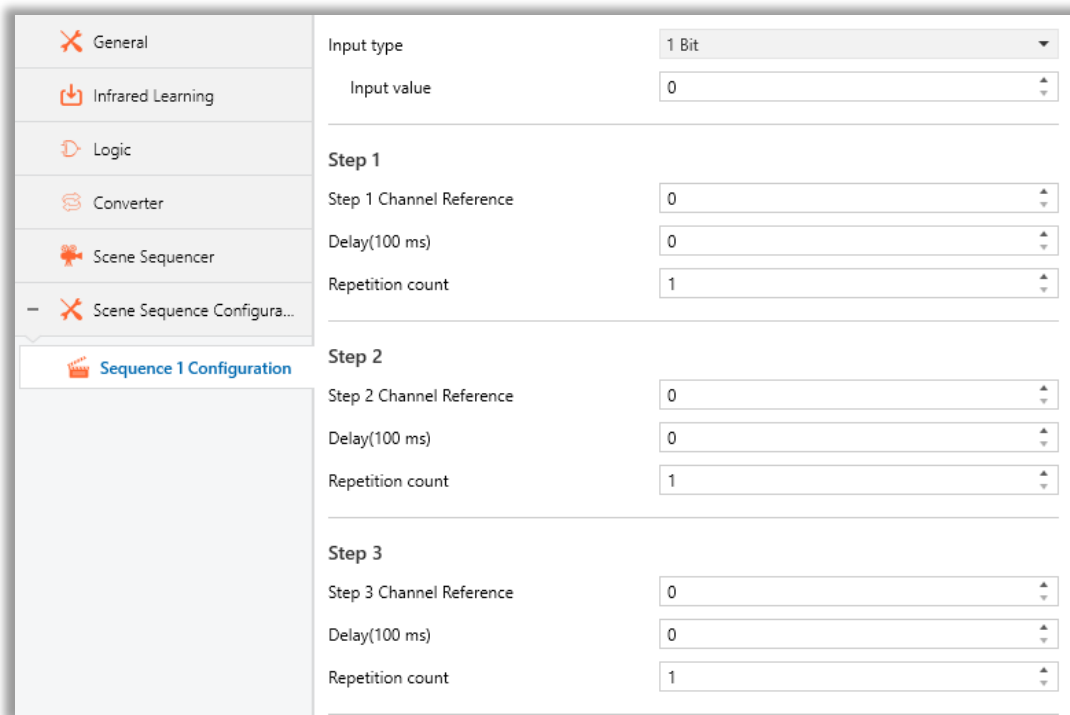

Fig. 10: Sequence X Configuration Page

3.6.1.1. Parameters List

PARAMETERS	DESCRIPTION	VALUES
Input type	This parameter is used to determine data type of Input object.	1 Bit 1 Byte
-> Input Value	This parameter determines the input value.	0...1 0...255
Step X		
Step X Channel Reference	This parameter is used to select the channel to be active in the step. 0: This value disables the step	0...64
Delay (100 ms)	This parameter is used to determine the delay time.	0...65535
Repetition count	This parameter is used to determine the number of repetitions of the selected step.	1...10

4. ETS Objects List & Descriptions

The iX3 KNX Room Controllers can communicate via the KNX bus line. In this section, the group objects of the iX3 KNX Room Controllers are described, which of these group objects are visible and capable of being linked with group addresses are explained in sub-sections.

No	Name	Function	DTP Type	Length	Flags				
					C	R	W	T	U
1, 9, ..., 497, 505	[X] Channel X	1 Bit input	1.006	1 bit	X		X		
		1 Bit output	1.006	1 bit	X		X		
2, 10, ..., 498, 506	[X] Channel X	2 Bit input	2.001	2 bits	X		X		
		2 Bit output	2.001	2 bits	X		X		
4, 12, ..., 500, 508	[X] Channel X	1 Byte input	5.005	1 byte	X		X		
		1 Byte output	5.005	1 byte	X		X		
5, 13, ..., 501, 509	[X] Channel X	2 Byte input	7.001	2 Bytes	X		X		
		2 Byte float input	9.001						
		2 Byte output	7.001						
		2 Byte float output	9.001						
7, 15, ..., 503, 511	[X] Channel X	4 Byte input	13.001	4 bytes	X		X		
		4 Byte output	13.001	4 bytes	X		X		
8, 16, ..., 504, 512	[X] Channel X	14 Byte raw data input	16.*	14 bytes	X		X		
		14 bytes ascii input	16.001						
		14 Byte raw data output	16.*						
		14 bytes ascii output	16.001						
513, 515, ..., 541, 543	[X] Sequence X	Scene sequence activation, 1 bit	1.001	1 bit	X		X		
514, 516, ..., 542, 544	[X] Sequence X	Scene sequence activation, 1 byte	5.010	1 byte	X		X		
613, 618, 623, 628	Logic X – Input 1	Logic Input	1.002	1 bit	X	X	X		
614, 619, 624, 629	Logic X – Input 2	Logic Input	1.002	1 bit	X	X	X		
615, 620, 625, 630	Logic X – Input 3	Logic Input	1.002	1 bit	X	X	X		
616, 621, 626, 631	Logic X – Input 4	Logic Input	1.002	1 bit	X	X	X		

617, 622, 627, 632	Logic X – Output	Logic Output	1.002	1 bit	X	X		X	
633, 641, ..., 688, 692	Converter X – Input	Converter Input	1.006	1 bit	X	X	X		
			2.006	2 bits	X	X	X		
			5.010	1 byte	X	X	X		
			7.001	2 bytes	X	X	X		
637, 645, ..., 685, 696	Converter X - Output	Converter Output	1.006	1 bit	X	X	X	X	
			2.006	2 bits	X	X	X	X	
			5.010	1 byte	X	X	X	X	
			7.001	2 bytes	X	X	X	X	

4.1. Logic Gate Objects

This section describes the "Logic Gate" group objects and their properties. Logic Gate group objects, as the name suggests, indicate the logical operations that can be made with Gateway.

Object Number	Object Name	Function	Type	Flags
2, 3, 4, 5, 7, 8, 9, 10,12, 13, 14, 15, 17, 18, 19, 20	Logic X – Input 1 Logic X – Input 2 Logic X – Input 3 Logic X – Input 4	Logic Input	1 bit	CRW

This object is used to set the inputs of the logical gate to be used. Logical associations can be made over 1-bit values. The result is obtained according to the type of logical gate selected.

DPT: 1.002 (Boolean)

6, 11, 16, 21	Logic X – Output	Logic Output	1 bit	CRT
---------------	------------------	--------------	-------	-----

This object is used to obtain the result of the logical gate to be used. The output value of the logical gate is 1 bit. The result is obtained according to the type of logical gate selected.

DPT: 1.002 (Boolean)

Special Notes



This is a fully compatible KNX device that must be configured and set up using the standard KNX tool ETS. Up to 4 different logic gates can be selected. Each logic gate can be set independently.

4.2. Converter Objects

This section describes the "Converter" group objects and their properties. Converter group objects are used to make mathematical operations and data converting from different types. Up to 8 different converters can be configured.

Object Number	Object Name	Function	Type	Flags
22, 23, 24, 25/ 30, 31, 32, 33/... 78, 79, 80, 81	Converter X – Input (1 Bit)	Converter Input	1 bit	CRW
	Converter X – Input (2 Bits)		2 bits	
	Converter X – Input (1 Byte)		1 byte	
	Converter X – Input (2 Bytes)		2 bytes	

This object is used to set the converter inputs to be used. The conversion processes can be made via 1 bit, 2-bit, 1 byte and 2 bytes values. The result is obtained according to the input type of the selected converter.

DPT:

- 1 Bit (1.006 Binary Value)
- 2 Bits (2.006 Binary Value)
- 1 Byte (5.010 Counter Pulses (0...255))
- 2 Bytes (7.001 Pulses)

26, 27, 28, 29/ 34, 35, 36, 37/... 82, 83, 84, 85	Converter X – Output (1 Bit)	Converter Output	1 bit	CRWT
	Converter X – Output (2 Bits)		2 bits	
	Converter X – Output (1 Byte)		1 byte	
	Converter X – Output (2 Bytes)		2 bytes	

This object is used to obtain the result of the converter to be used. The output value of the converter can be 1 bit, 2-bit, 1 byte and 2 bytes. The result is obtained according to the configuration of the selected converter.

DPT:

- 1 Bit (1.006 Binary Value)
- 2 Bits (2.006 Binary Value)
- 1 Byte (5.010 Counter Pulses (0...255))
- 2 Bytes (7.001 Pulses)

4.3. Sequence Objects

In this section, Button objects are described in the table below. In the first column name of the object, in the second column function name, the third column data type and fourth column the objects flags, information is given.

X: 1 ... 16,

Object Number	Object Name	Function	Type	Flags
513, 515 ..., 541, 543	[X] Sequence X	Scene sequence activation, 1 bit	1 bit	CW

This object is used to trigger the sequence with selected bit value.

DPT: 1.001 (switch)

514, 516 ..., 542, 544	[X] Sequence X	Scene sequence activation, 1 byte	1 byte	CW
------------------------------	----------------	-----------------------------------	--------	----

This object is used to trigger the sequence with selected byte value.

DPT: 5.010 (counter pulses (0...255))

4.4. Channel Objects

This section describes the "general" group objects and their properties. General group objects, as the name suggests, indicate the general characteristics of the iX3.

Object Number	Object Name	Function	Type	Flags
1, 9, ..., 497, 505	[X] Channel X	1 Bit input / 1 Bit output	1 bit	CW

This object is used to trigger the IR send channel with the selected bit value for the KNX to IR operating style. For IR to KNX operation, it is triggered by IR and used to send bit value to the KNX bus.
DPT: 1.006 (binary value)

2, 10 ..., 498, 506	[X] Channel X	2 Bit input / 2 Bit output	2 bit	CW
---------------------------	---------------	----------------------------	-------	----

This object is used to trigger the IR send channel with the selected 2-bit value for the KNX to IR operating style. For IR to KNX operation, it is triggered by IR and used to send 2-bit value to the KNX bus.
DPT: 2.001 (switch control)

4, 12 ..., 500, 508	[X] Channel X	1 Byte input / 1 Byte output	1 byte	CW
---------------------------	---------------	------------------------------	--------	----

This object is used to trigger the IR send channel with the selected byte value for the KNX to IR operating style. For IR to KNX operation, it is triggered by IR and used to send byte value to the KNX bus.
DPT: 5.005 (ratio (0..255))

5, 13 ..., 501, 509	[X] Channel X	2 Byte input / 2 Byte output	2 Bytes	CW
		2 Byte float input / 2 Byte float output		

This object is used to trigger the IR send channel with the selected 2 bytes value for the KNX to IR operating style. For IR to KNX operation, it is triggered by IR and used to send 2 bytes value to the KNX bus.
DPT:
7.001 (pulses)
9.001 (temperature (°C))

7, 15 ..., 503, 511	[X] Channel X	4 Byte input / 4 Byte output	4 bytes	CW
---	----------------------	-------------------------------------	----------------	-----------

This object is used to trigger the IR send channel with the selected 4 bytes value for the KNX to IR operating style. For IR to KNX operation, it is triggered by IR and used to send 4 bytes value to the KNX bus.

DPT: 13.001 (counter pulses (signed))

8,16 ..., 504, 512	[X] Channel X	14 Byte raw data input / 14 Byte raw data output	14 bytes	CW
		14 byte ascii input / 14 byte ascii output		

This object is used to trigger the IR send channel with the selected 14 bytes value for the KNX to IR operating style. For IR to KNX operation, it is triggered by IR and used to send 14 bytes value to the KNX bus.

DPT:

16.* (character string)

16.001 (Character string (ISO 8859-1))

IR Gateway Accessories

- The following table lists Receiver and Transmitter cables compatible with our IR Gateway product. These cables are not included with the product and customers need to place an additional order for them.

Cable Type	Cable Code	Cable Name	Cable Length
Receiver	HM002024	Assemble Cable IR Receiver Connection	1 Meter
Receiver	HM002026	Assemble Cable IR Receiver Connection	5 Meter
Receiver	HM002028	Assemble Cable IR Receiver Connection	10 Meter
Transmitter	HM002023	Assemble Cable IR Transmitter Connection	1 Meter
Transmitter	HM002025	Assemble Cable IR Transmitter Connection	5 Meter
Transmitter	HM002027	Assemble Cable IR Transmitter Connection	10 Meter

CONTACT INFORMATION

THE INTERRA WEBSITE

Interra provides documentation support via our website www.interratechnology.com. This website is used as a means to make files and information easily available to customers. Accessible by using your favourite Internet browser, the website contains the following information:

- Information about our products and projects.
- Overview of Interra company and values.
- Product Support: Datasheets, product manuals, application descriptions, latest software releases, ETS databases and archived software.

EUROPE, Turkey

Interra

Cumhuriyet Mah. Kartal Cad. Interra R&D Centre
 No:95/1 Kartal/Istanbul

Tel: +90 (216) 326 26 40 Fax: +90 (216) 324 25 03

Web address: <http://www.interratechnology.com>