

Villa Outdoor Intercom Unit with Linux OS



Product Code	ITR641-0002
Power Supply	12 V DC, PoE
Power Consumption	1.5 W (Standby Power), 3 W (Rated Power)
Communication	TCP/IP, SIP, VOIP, RTSP
Operating System	Linux
CPU	1 GHz
Memory	64 MB SD Ram 128 MB Flash
Button	One mechanical button
Reader	20,000 IC/ID Cards
Door Relay Control Method	DTMF, HTTP, IC/ID Card
Video Codec	H.264
Audio Codec	G.711
Camera	2 MP CMOS
Night Vision	LED Night Vision
Type of Protection	IP 65
Temperature Range	Operation (-40°C...70°C) Storage (-10°C...70°C)
Maximum Air Humidity	< 93 RH
Material	Plastic
Colour	Light Grey , Black
Dimensions	Product: 116 x 192 x 47 mm (W x H x D) Mounting Box: 102 x 177 x 45 mm (W x H x D)
Configuration	via Webpage

DESCRIPTION

Interra ITR641-0002 door front SIP intercom unit can be used to provide intelligent access control in places such as villas, residences, offices etc. With the card reader feature, you can provide access control and a high level of security in your building. Thanks to the high image quality, it is easier to recognize the guests in speeches made in dark environments with the night vision feature.

GENERAL FEATURES

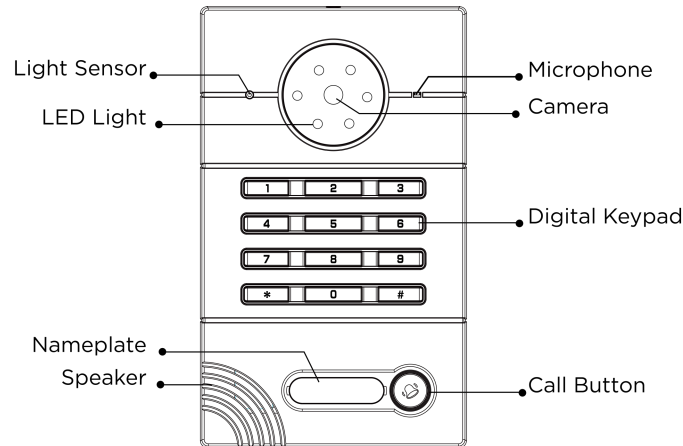

DIMENSIONS

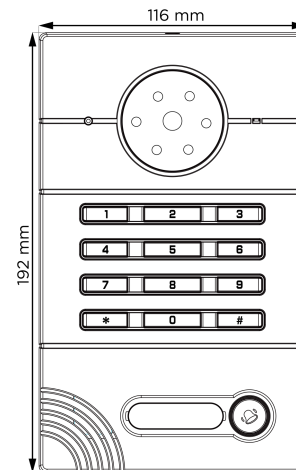

FUNCTIONS

ITR641-0002 is an Outdoor Panel Unit that is mainly used for making interacting with the related indoor intercom unit.

ITR641-0002 product features are described below:

- Call indoor monitor by one button
- Support unlocking by IC/ID access control card or DTMF.
- IC/ID card information can be registered on outdoor panel. Registration information of max. 20,000 IC/ID cards can be stored
- Support unlocking by Exit button and door magnetic detection
- Support LED light for night vision
- Support POE power supply (optional)

INSTALLATION

Please, perform the installation as indicated in the picture below.

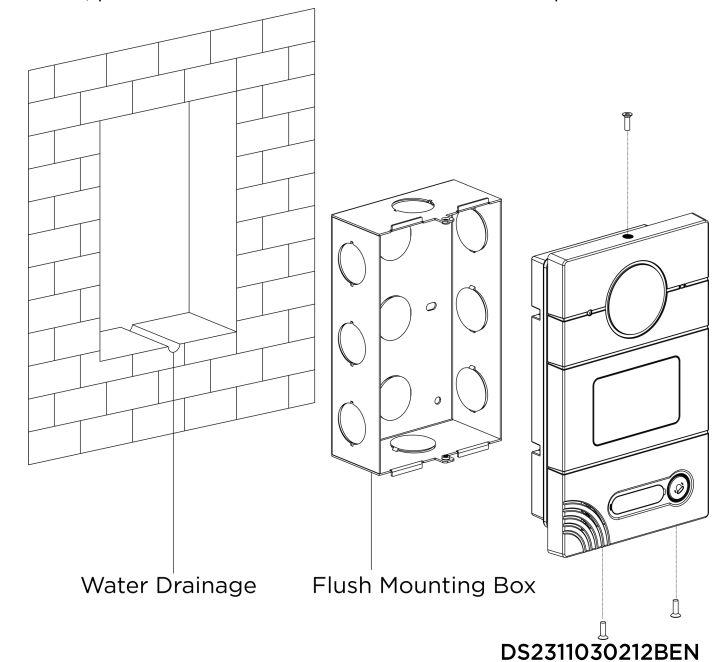

CONNECTION DIAGRAM & FEATURES

The following figure, shows a proper location of the installation:

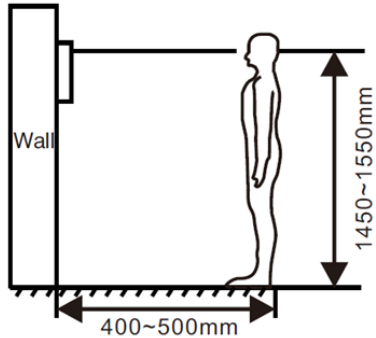

! During the installation, the camera should be 1450-1550 mm above the ground. The camera tether for photographing the human face should be the top priority.

System Diagram:

The following figures shows the connectors of the ITR641-0002.

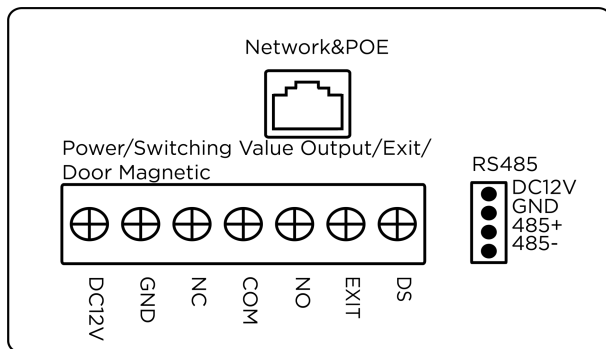

Power / Switching Value Output:

Power input interface connects with 12 V DC power adapter. It provides a contact signal of switching value and needs, independent power supply for the lock. The electric lock can be connected in two ways, including a normally-open connection and a normally-closed connection. Wiring diagram is as below:

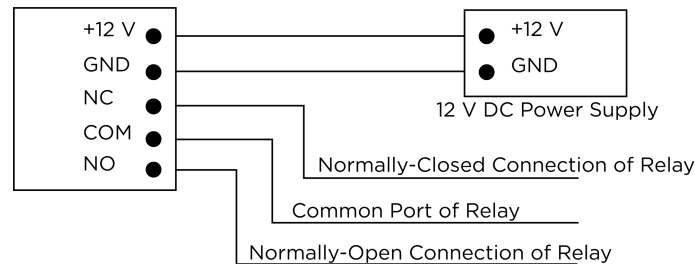

Exit Button/Door Magnetic Switch:

Connect with Exit button and door magnetic switch; DIN is reserved terminal, please don't connect it.

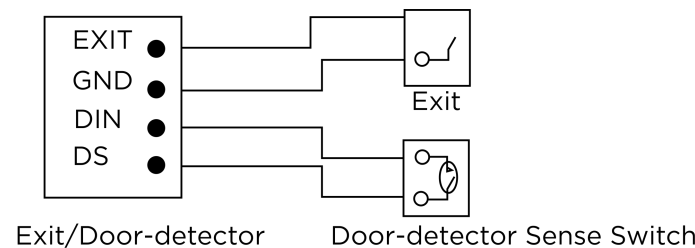
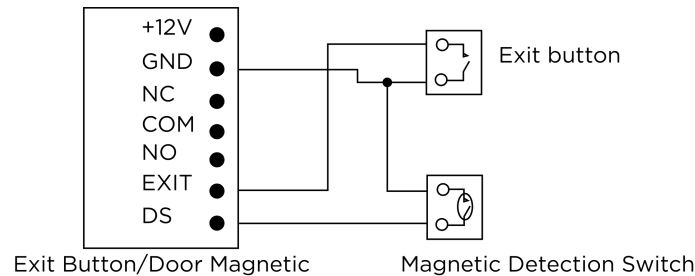

RS-485:

Connect with RS-485 device; RS-485 interface can output 12 V / 100 mA power supply. If RS-485 equipment to be connected does not require the power supply, no need to connect +12 V.

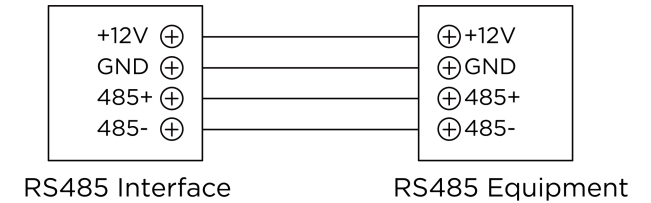

Network:

Connect to management center, indoor monitor or other network device through network switch.

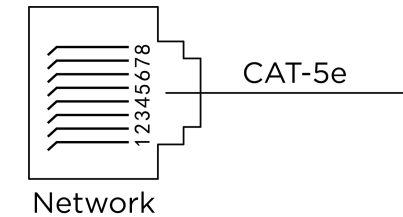

TROUBLESHOOTING

Some common failures and troubleshooting methods are listed for your reference. In case of failure which cannot be repaired, do not disassemble or repair the product by yourself. Please contact the after-sales technical service department.

- When setting villa outdoor panel, please make sure building No. and unit No. of the outdoor panel are the same as the ones of the indoor monitor.
- Please check whether the network is connected.
- Please check if there are any security settings for the network.