

Outdoor Glass Intercom Unit

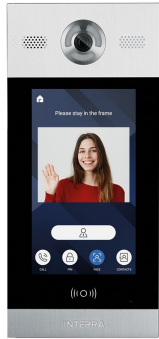

Product Code	ITR651-0003
Power Supply	12 V DC, PoE
Power Consumption	3 W (Standby Power), 13 W (Rated Power)
Communication	TCP/IP, SIP, VOIP, RTSP
Operating System	Android 4.4.2
CPU	Quad Core 1.3 GHz
Memory	512 MB SD Ram, 8 GB Flash,
Display	10.1" TFT LCD, 1024x600
Keypad	Touch Screen
Door Relay Control Method	DTMF, PIN Code, IC/ID Card, Face Recognition, NFC
Facial Recognition	10.000 different face recognition
Reader	100.000 IC/ID Cards
Video Codec	H.264
Audio Codec	G.711, G.729
Camera	2 MP CMOS, WDR
Night Vision	LED Night Vision
Type of Protection	IP 65
Temperature Range	Operation (-20°C...55°C), Storage (-40°C...70°C)
Maximum Air Humidity	< 93% RH
Material	Aluminum Alloy / Tempered Glass
Colour	Light Grey and Black
Dimensions	Product : 180x400x45 mm (W x H x D) Flush mounting box: 172x378x58 mm (W x H x D)
Configuration	via Webpage

DESCRIPTION

ITR651-0003 is an Outdoor Intercom Unit with Android OS that is mainly used for making interacting with the related indoor intercom unit such as an indoor monitor. It allows you to easily monitor an entrance door or gate and gives you the confidence that your home has more security. With the Outdoor Intercom unit, Users can communicate with visitors via voice and video call with an indoor intercom and mobile APP. With Outdoor Intercom, they can unlock the door if they need it. In addition, users can also use their IC/ID card and PIN Code to unlock the door.

FUNCTIONS

ITR651-0003 is an Outdoor Panel Unit that is mainly used for making interacting with the related indoor intercom unit. ITR651-0003 product features are described below:

- A Video intercom with indoor monitor and management centre.
- Door opening can be done with a password, IC / ID card and face recognition.
- It can register IC/ID card information on the outdoor panel and store up to 100,000 IC/ID cards (ID card is optional).
- Support Exit button unlocking and door magnetic detection.
- Face recognition with an infrared supported night vision camera.

INSTALLATION

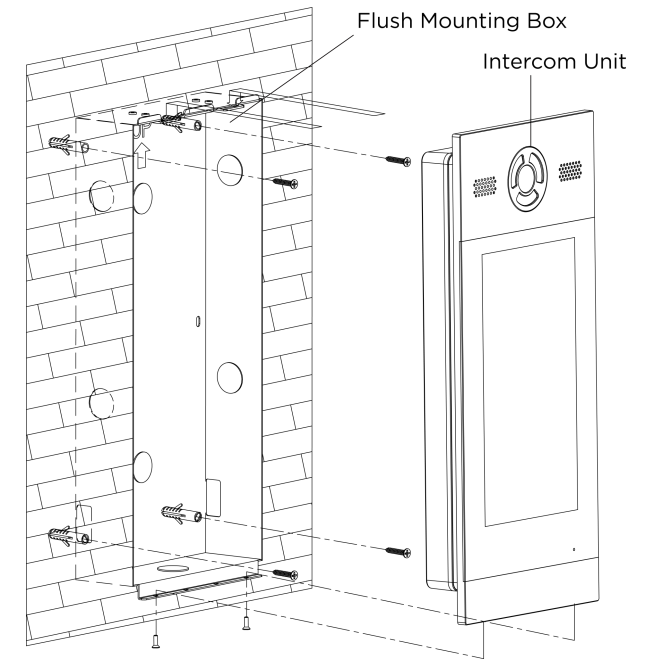

The following figure, shows the proper location of the installation:

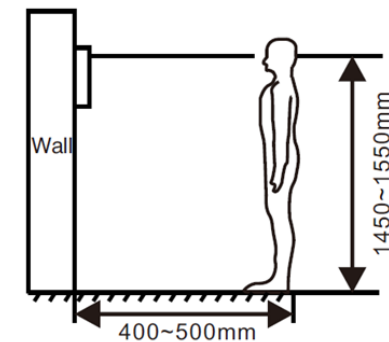

! During the installation, the camera should be 1450-1550 mm above the ground. The camera tether for photographing the human face should be the top priority.

CONNECTION DIAGRAM & FEATURES

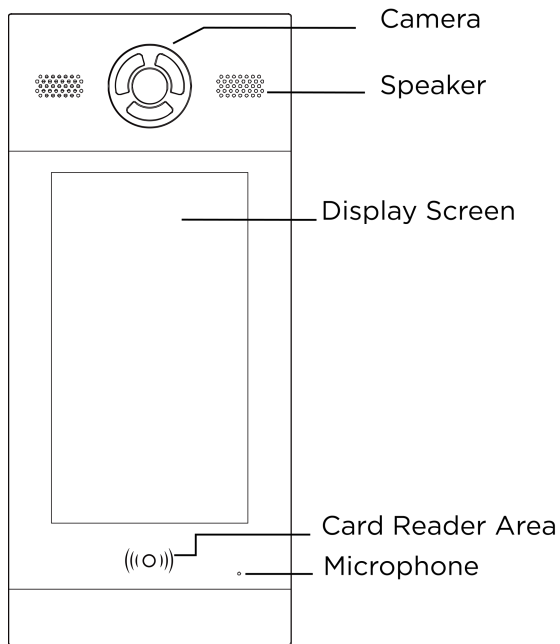

Power/Unlock Signal Output:

Power interface of intercom unit connects with 12 V DC power. Unlock signal output connects with the lock module.

Unlocking current can reach Max 3.5 A.

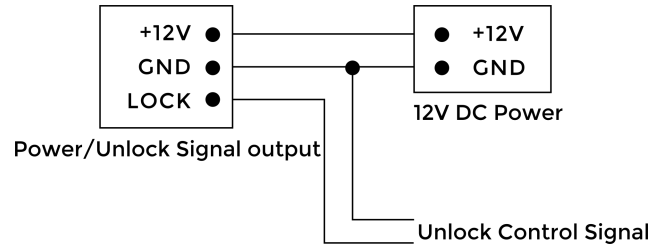

Card Reader Interface:

The interface can be connected to one IC/ID card reader or be used for reading the information of the built-in card reader. It can output the power 5 V/100 mA. When the card reader does not have the power from the interface, a wire connection of +5 V is not required:

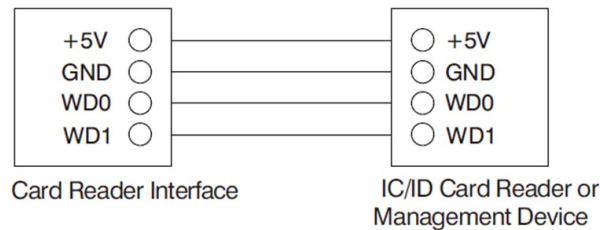

Switching Value Output:

Connect to the lock module (independent power supply is necessary for the lock).

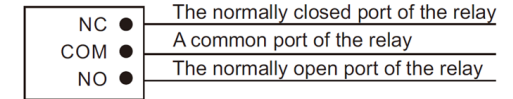

Switching Value Output

RS-485:

Connect with RS-485 device; RS-485 interface can output 12 V / 100 mA power supply. If RS-485 equipment to be connected does not require the power supply, no need to connect +12 V.

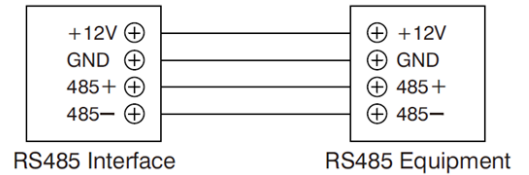

Network:

Connect to the management center, indoor monitor or another network device through a network switch.

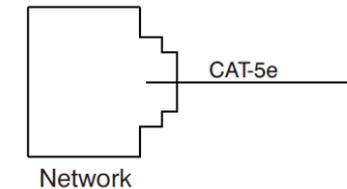

System Diagram:

The following figures shows the connectors of the ITR651-0003.

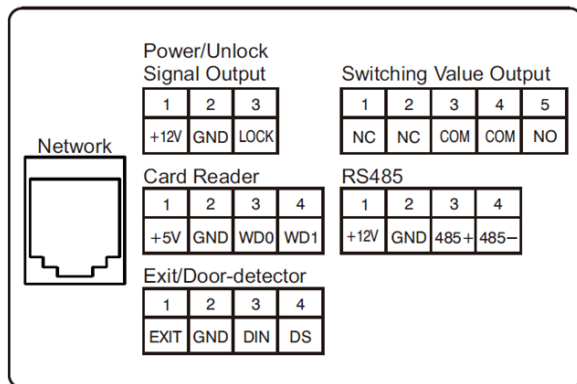

Exit Button/Door Magnetic Switch:

Connect with Exit button and door magnetic switch; DIN is reserved terminal, please don't connect it.

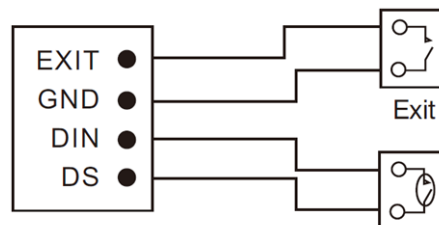

Exit/Door-detector

Door-detector Sense Switch

TROUBLESHOOTING

Some common failures and troubleshooting methods are listed for your reference. In case of failure which cannot be repaired, do not disassemble or repair the product by yourself. Please contact the after-sales technical service department.

When setting outdoor panel, please make sure building No. and unit No. of the outdoor panel are the same as the ones of the indoor monitor.

Please check whether the network is connected.

Please check if there are any security settings for the network.