

Mid-Range DALI Presence Sensor



Product Code	ITR415-1X01
Sensor Technology	Passive Infrared
Power Supply	19 V DC Power Supply
Installation environment	Indoor
Mounting height	2.5 m - 4 m
Current Consumption	5 mA
Brightness Detection	1-1200 lux
Inputs	2 x Digital Input, 1 x Analog Input
Maximum Air Humidity	% 90 RH
Pollution Degree	2
Type of Protection	Flush Mount : IP 20 Surface Mount : IP 44
Temperature Range	Operation (-5°C...45°C) Storage (-10°C...60°C)
Dimensions	70 x 41,8 mm (Φ x H)
Colour	Black and White

X | 0: White / 1: Black



DESCRIPTION

ITR415-1X01 - Mid-Range DALI Presence Sensor is a multi-functional device suitable for indoor usages with mid-range detection capability. It includes 4 independent presence channels that can be used with constant light switch and constant light controller functionality. Independent presence channels can be configured as the automatic or semi-automatic mode for user requirements. Moreover, ITR415-1X01 also supports sensor functionality without presence channels for simple usage. Temperature measurements can be made via an integrated temperature sensor and temperature information can be reported to DALI bus. ITR415-1X01 also includes 5 independent logic blocks to make logical associations. The logical blocks can be associated with such as “AND”, “OR” and “XOR” logic. The logic input conditions contain presence, brightness, movement and external conditions. The sensor also can be configured as the master or slave mode.

DETECTION RANGE

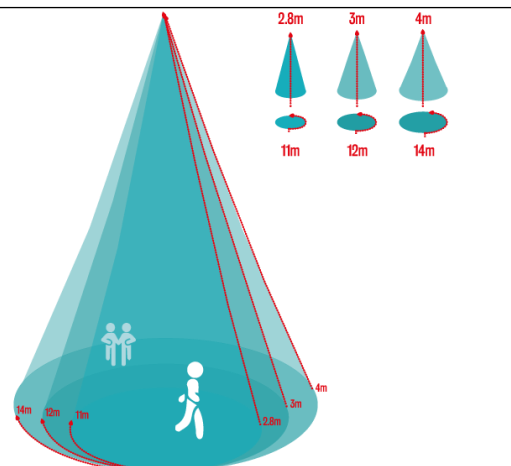

Mounting Height	Seated Activity	Walking Towards	Walking Across
2.8 m	5.5 m	6 m	11 m
3 m	6 m	7 m	12 m
4 m	7 m	8 m	14 m

FUNCTIONS

- ITR415-1X01 supports presence detection, brightness detection, movement detection, and internal and external temperature detection.
- Presence detection, based on a passive infrared sensor, has 4 independently configurable channels with a constant light switch and constant light control application.
- External devices can be connected via 2 digital inputs and 1 analog input. 2 digital inputs are used for Push-Buttons and analog input is used for the external temperature sensors.
- Every instance can transmit events to inform another bus unit. It is possible to disable events if we aren't interested in the event.

Push-Button

- The instance number of Push Buttons is Instance 0 and Instance 1.
- As explained in the standards it can send nine kinds of events which are; “Button released”, “Button pressed”, “Short press”, “Double press”, “Long press start”, “Long press repeat”, “Long press stop”, “Button free” and “Button stuck”.

Absolute Input

- The instance number of the internal temperature sensor is 2 and the external temperature sensor is 3.
- An absolute input device includes one event which represents an input value. Encoding of the input value is that the value of 0 represents -5°C and 1023 represents +55°C. The temperature value between those two numbers is linear.

Occupancy Sensor



- The instance number of occupancy sensors is 4.
- Occupancy sensors can send 8 different events. They are “No movement”, “Movement”, “Vacant”, “Still vacant”, “Occupied”, “Still occupied”, “Presence sensor” and “Movement sensor”.
- The occupancy sensor sends an event on every change of input value or when the report timer expires.

Light Sensor

- The instance number of occupancy sensors is 5.
- The light sensor can send one case to show the illuminance level, whose unit is lux.

USEFUL INSTALLATION TIPS

As the sensor reacts to temperature changes, the following conditions should be avoided:

-  Avoid targeting the sensor toward the objects which may be swayed in the wind, such as curtain, tall plants, miniature etc.
-  Avoid targeting the sensor toward the objects whose surfaces are highly reflective, such as mirror, glass and pool, etc.
-  The sensor should be mounted away from heat sources such as air conditioning, lights, heating vents etc.

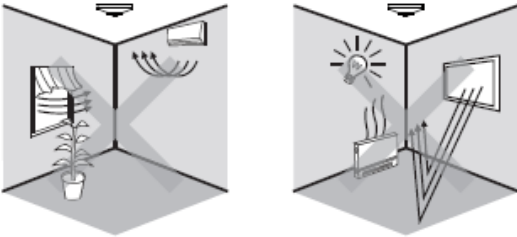

IMPORTANT NOTES

- For planning and construction of electric installations the appropriate specifications, guidelines and regulations in force of the respective country have to be complied.
- Special Programming: ITR415-1X01 is designed for professional DALI installation. It only can be programmed by Additional Software.
- Cable Connections: Ensure making correct connections for wires.
- Voltage: The input voltage shall be 19 V DC.
- Mounting Location: Installed indoors, to avoid installation near the air-conditioner vent, and be away from the heat source.
- The tightening torque shall not exceed 0.2 Nm.
- Avoid contact with liquids and corrosive gases.

TECHNICAL DRAWINGS

Technical drawings and dimensions for flush mounted and surface mounted sensor models are given below. All dimensions specified for technical drawings are in millimeters.

Flush Mounted :

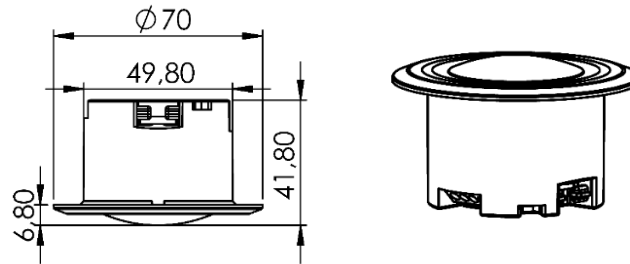

Surface Mounted :

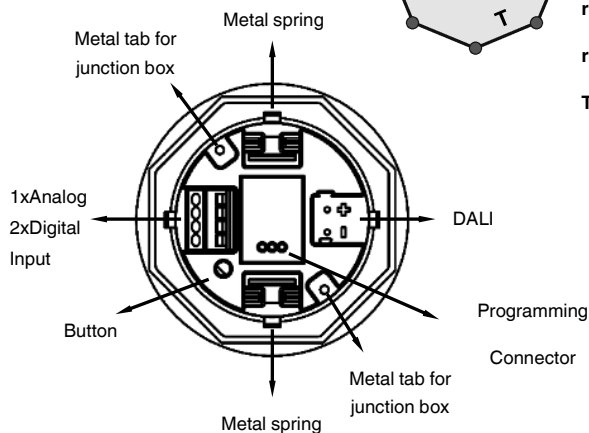
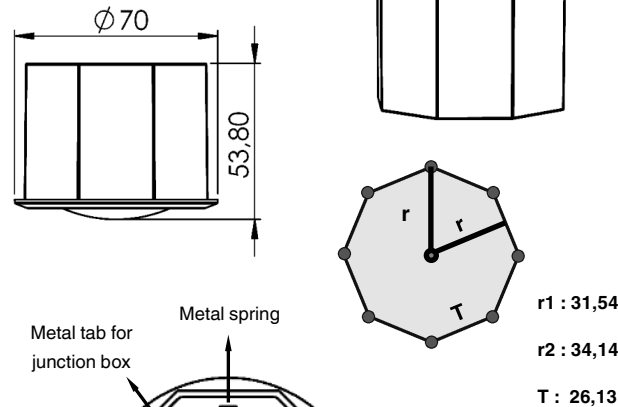

MOUNTING

The device can be mounted either in the ceiling via flush mounting housing or on the ceiling via the optionally available surface-mounted box.

Flush Mount Process:

- First, a slot hole of suitable size for sensor mounting is opened on the ceiling surface to be flush mounted.
- Then, DALI cable and input cable, if any, are connected to the relevant connectors on the sensor.
- The 2 metal springs on the sensor are stretched and then the sensor is attached to the hole on the ceiling. Thus, mounting process is finished.

Surface Mount Process:

- First, a hole of suitable size for cables is opened on the ceiling surface.
- Second, the octagonal surface junction box where the sensor will be placed is screwed to the ceiling.
- Then, DALI cable and input cable, if any, are connected to the relevant connectors on the sensor.
- The 2 metal springs on the sensor housing are removed and then the metal tabs are attached to the sensor housing. Then, the sensor is mounted to junction box. Thus, mounting process is completed.

CALIBRATION

There is the option of carrying out a brightness adjustment for the sensor via the brightness detection application with the aid of the Software parameters and objects.

Calibration Procedure :

- Perform the measurement during sufficient daylight ($> 1/2 * \text{setpoint}$).
- Switch off the light source.
- Carry out the measurement of brightness at a defined location with a luxmeter. For instance, lying down at the workplace with a view toward the ceiling and wait until the light is close to being constant. Send the value to the device using the brightness calibration object via Software as soon as possible after measuring.