

INTERRA

— Developer of Uniqueness —

INTERRA KNX / AC Gateway Series



DAIKIN MITSUBISHI HEAVY INDUSTRIES MITSUBISHI ELECTRIC SAMSUNG arçelik LG GREE TOSHIBA Vaillant VIESSMANN DemirDöküm Midea

interratechnology.com

CONTENTS

• Interra - Developer of Uniqueness	3
• Mitsubishi Electric AC / KNX Gateway	4
• Daikin Split AC / KNX Gateway	5
• Daikin Sky AC / KNX Gateway	6
• Mitsubishi Heavy AC / KNX Gateway	7
• Samsung NASA AC / KNX Gateway	8-10
• LG AC / KNX Gateway	11
• Arçelik AC / KNX Gateway	12
• Viessmann Homebus AB Port AC / KNX Gateway	13
• Gree VRF AC / KNX Gateway	14
• Vaillant AC / KNX Gateway	15
• DemirDöküm AC / KNX Gateway	16
• Gree Split AC / KNX Gateway	17
• Midea AC / KNX Gateway	18
• Toshiba AC / KNX Gateway	19
• Viessmann Split AC / KNX Gateway	20



Interra - Developer of Uniqueness

In recent years, with the huge growth rates, Interra has been managed to be one of the most popular KNX based home automation brands globally. In 2020, Interra started its first attempt of integrating air conditioning units into the KNX systems and creating bi-directional communication between them to increase the energy efficiency and capabilities of smart buildings. With the support of The Scientific and Technological Research Council of Turkey and the collaboration with air conditioning manufacturers to ensure to keep the right compatibility with their AC units, Interra succeeded to create reliable KNX gateway units for major international brands.

Unique HVAC Solutions for KNX Professionals

Bi-directional Communication

Interra KNX / AC Gateways provide complete bi-directional integration of air conditioners with KNX bus. Get or send any information from the AC unit to control and monitor it on your KNX bus.



Approved Reliability

Interra AC Gateways are developed with the collaboration of air conditioning manufacturers to ensure to keep the right compatibility with their AC units. Interra has special agreements with some air conditioning manufacturers where they are the exclusive distributors of Interra AC / KNX Gateways in their regions.

Easy to Setup

With its minimalistic design, very easy to implement, hide and connect AC to the KNX bus.

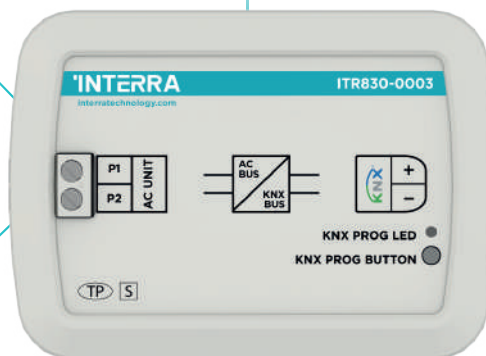

Energy Efficient

HVAC systems are the biggest part of the energy costs in buildings. Interra AC Gateway units provide smart scenarios and special modes for your needs to keep your energy usage at optimal levels.



Trusted by KNX Professionals

Interra is one of the most popular KNX brands in the world and trusted by more than 430 KNX integrators only in 2021.

More features by KNX

- Mobile Control
- Personalized / Timer Scenarios
- Energy Consumption & Savings
- Energy Monitoring
- Air Quality Monitoring*

Mitsubishi Electric AC / KNX Gateway

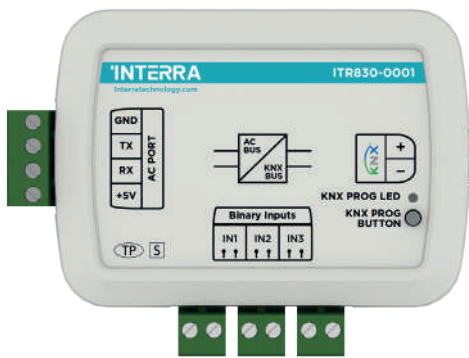

ITR830-0001

ITR830-0001 is used for monitoring and controlling all the functioning parameters of Mitsubishi Electric air conditioners with KNX. It is compatible with models in PAC, RAC, and City Multi VRF and Industrial types sold by Mitsubishi Electric. For more information please check the compatibility list on our website.

FUNCTIONS

- ITR830-0001 provides complete bi-directional integration of Mitsubishi Electric air conditioners with KNX bus.
- It provides extra communication objects for maximum flexibility.
- It includes 4 logical and 8 converter advanced parameters for energy savings, configurable scenes, temperature limits, etc.
- It includes 3 binary inputs to integrate into the KNX bus. (i.e. motion detectors, evacuation pumps, window contacts)
- Mitsubishi Electric air conditioner unit provides error notifications for errors that may occur in exceptional cases.

Technical Specifications

Product Code	ITR830-0001
Power Supply	KNX Power Supply
Power Consumption	5 mA
Inputs	3 binary inputs
Push Buttons	1 x KNX Programming Button
LED Indicators	1 x KNX Programming LED
Type of Protection	IP 20
Mode of Commissioning	S-Mode
Maximum Air Humidity	< 90 RH
Temperature Range	Operation (-10°C...70°C) Storage (-25°C...100°C)
Colour	Light Grey
Dimensions	40 x 10 x 40 mm (W x H x D)
Certification	KNX Certified
Configuration	Configuration with ETS
© 2022 INTERRA	

OVERVIEW

Mitsubishi Electric AC 7 KNX Gateway has a very easy installation and can be installed into the AC indoor unit or a proper location away from the air conditioner. Its one side is connected directly to the electronic circuit of the AC indoor unit and on the other side directly to the KNX bus.

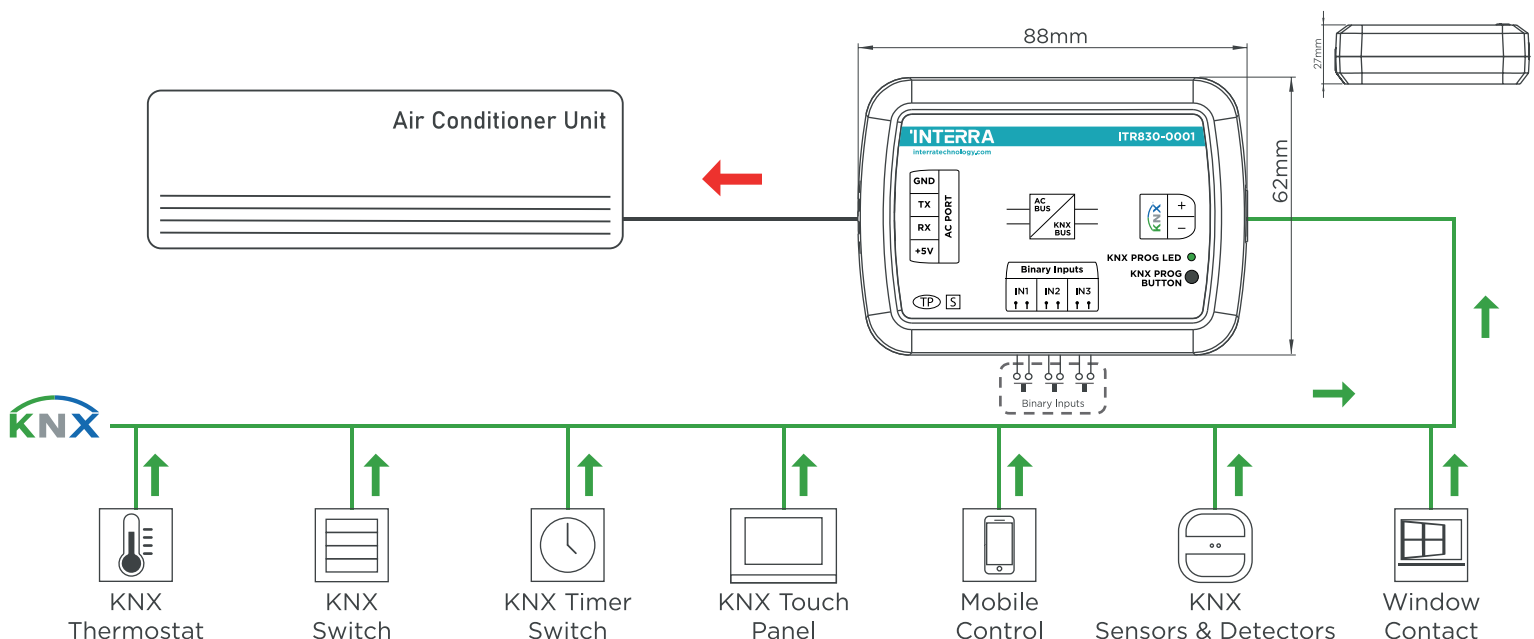

Daikin Split AC / KNX Gateway

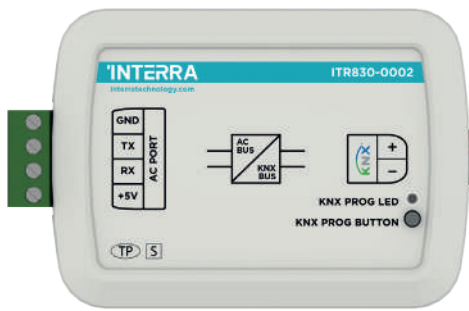

ITR830-0002

ITR830-0002 is an air conditioner gateway that is used for monitoring and controlling all the functioning parameters of Daikin Industries air conditioners via the KNX bus line. Daikin Split AC - KNX Gateway is compatible with models in Daikin Split types categorized in the compatibility list sold by Daikin Industries.

FUNCTIONS

- ITR830-0002 provides complete bi-directional integration of Daikin Split air conditioners with KNX bus.
- It includes 4 logical advanced parameters, each logical parameter has up to 4 inputs and can be configured as AND, OR & XOR.
- Includes 8 advanced converter parameters, each converter has four operations math calculations according to the input type.
- Logic and converter parameters can be used for energy savings, configurable scenes, temperature limits, etc.
- Daikin air conditioner unit provides error notifications for errors that may occur in exceptional cases.

Technical Specifications

Product Code	ITR830-0002
Power Supply	KNX Power Supply
Power Consumption	5 mA
Push Buttons	1 x KNX Programming Button
LED Indicators	1 x KNX Programming LED
Type of Protection	IP 20
Mode of Commissioning	S-Mode
Maximum Air Humidity	< 90 RH
Temperature Range	Operation (-10°C...70°C) Storage (-25°C...100°C)
Colour	Light Grey
Dimensions	88 x 62 x 27 mm (W x H x D)
Certification	KNX Certified
Configuration	Configuration with ETS

© 2022 INTERRA



OVERVIEW

Daikin Split AC - KNX Gateway has a very easy installation and can be installed into the AC indoor unit or a proper location away from the air conditioner. Its one side is connected directly to the electronic circuit of the AC indoor unit and on the other side directly to the KNX bus.

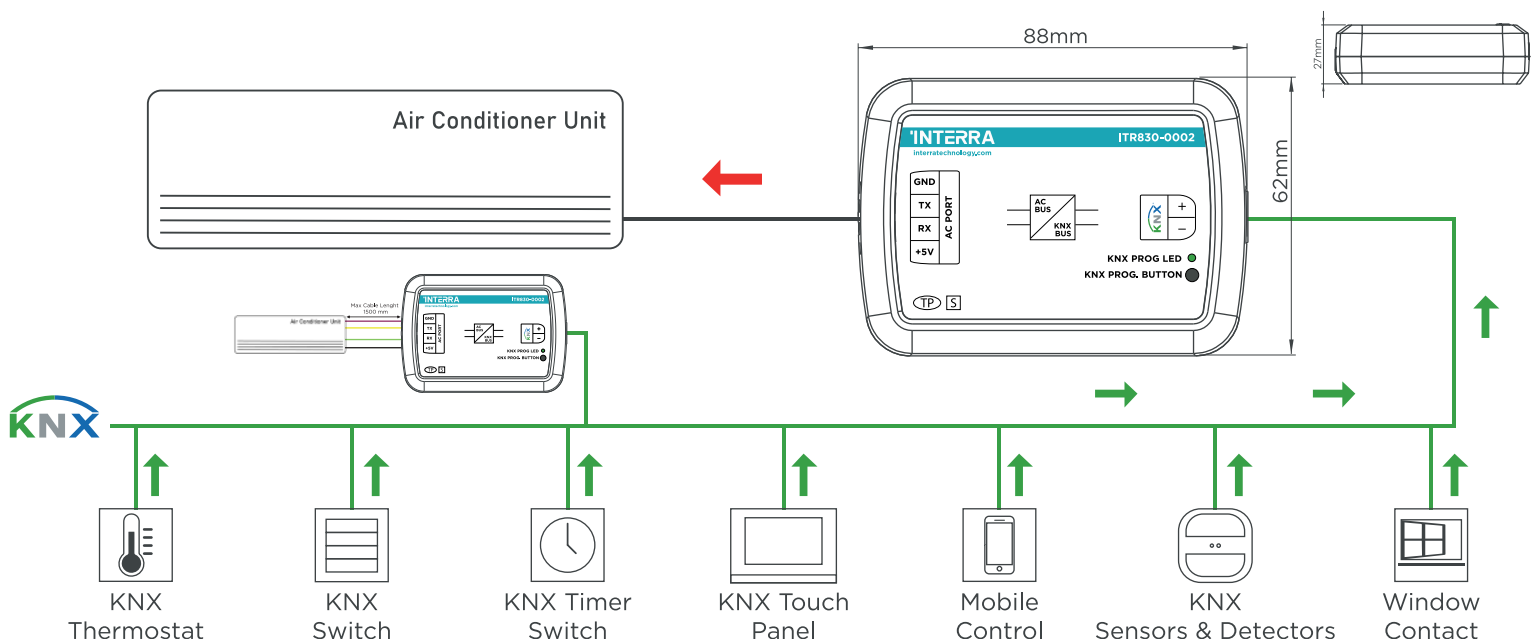

Daikin Sky AC / KNX Gateway

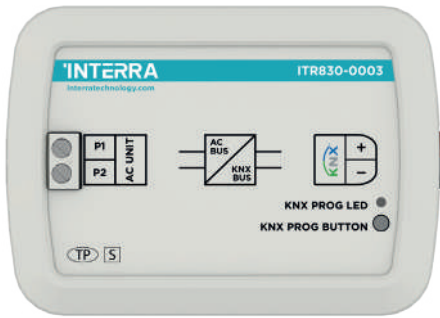

ITR830-0003

ITR830-0003 is an air conditioner gateway that is used for monitoring and controlling all the functioning parameters of Daikin Industries air conditioners via the KNX bus line. Daikin Sky & VRV AC - KNX Gateway is compatible with models in Sky & VRV types categorized in the compatibility list sold by Daikin Industries.

FUNCTIONS

- ITR830-0003 provides complete bi-directional integration of Daikin Sky & VRV air conditioners with KNX bus.
- It includes 4 logical advanced parameters, each logical parameter has up to 4 inputs and can be configured as AND, OR & XOR.
- Includes 8 advanced converter parameters, each converter has four operations math calculations according to the input type.
- Logic and converter parameters can be used for energy savings, configurable scenes, temperature limits, etc.
- Daikin air conditioner unit provides error notifications for errors that may occur in exceptional cases.

Technical Specifications

Product Code	ITR830-0003
Power Supply	KNX Power Supply
Power Consumption	5 mA
Push Buttons	1 x KNX Programming Button
LED Indicators	1 x KNX Programming LED
Type of Protection	IP 20
Cable Distance	Max 350 m
Mode of Commissioning	S-Mode
Maximum Air Humidity	< 90 RH
Temperature Range	Operation (-10°C...70°C) Storage (-25°C...100°C)
Colour	Light Grey
Dimensions	88 x 62 x 27 mm (W x H x D)
Certification	KNX Certified
Configuration	Configuration with ETS
© 2022 INTERRA	

OVERVIEW

Daikin Sky & VRV AC - KNX Gateway has a very easy installation and can be installed into the AC indoor unit or a proper location away from the air conditioner. Its one side is connected directly to the electronic circuit of the AC indoor unit and on the other side directly to the KNX bus.

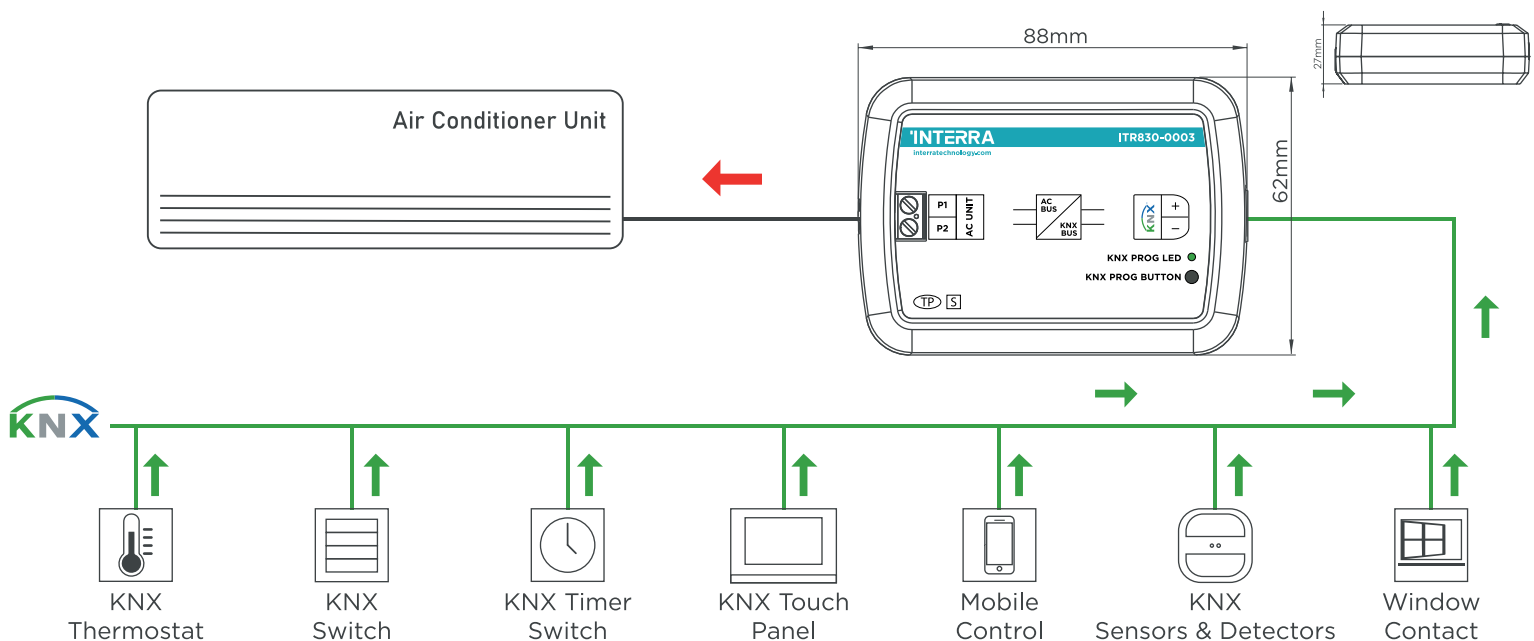

Mitsubishi Heavy AC / KNX Gateway

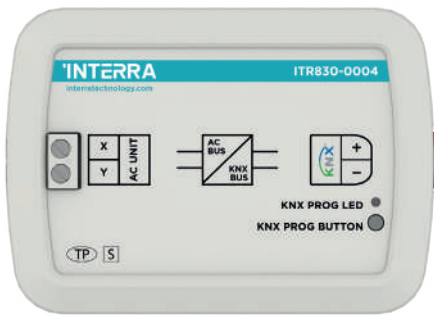

ITR830-0004

ITR830-0004 is used for monitoring and controlling all the functioning parameters of Mitsubishi Heavy air conditioners with KNX. It is compatible with the RAC* series, FD Series, KX6, and KXR6 (VRF) series types categorized at compatibility list sold by Mitsubishi Heavy Industries. For more information please check the compatibility list on our website.

FUNCTIONS

- ITR830-0004 provides complete bi-directional integration of Mitsubishi Heavy air conditioners with KNX bus.
- It includes 4 logical advanced parameters, each logical parameter has up to 4 inputs and can be configured as AND, OR & XOR.
- It includes 8 advanced converter parameters and each converter has four operations math calculations according to the input type.
- Logic and converter parameters can be used for energy savings, configurable scenes, temperature limits, etc.
- The Mitsubishi Heavy AC - KNX gateway provides error notifications for errors that may occur in exceptional cases.

Technical Specifications

Product Code	ITR830-0004
Power Supply	KNX Power Supply
Power Consumption	5 mA
Push Buttons	1 x KNX Programming Button
LED Indicators	1 x KNX Programming LED
Type of Protection	IP 20
Cable Distance	Max 350
Mode of Commissioning	S-Mode
Maximum Air Humidity	< 90 RH
Temperature Range	Operation (-10°C...70°C) Storage (-25°C...100°C)
Colour	Light Grey
Dimensions	88 x 62 x 27 mm (W x H x D)
Certification	KNX Certified
Configuration	Configuration with ETS
© 2022 INTERRA	

OVERVIEW

Mitsubishi Heavy AC / KNX Gateway has a very easy installation and can be installed into the AC indoor unit or a proper location away from the air conditioner. Its one side is connected directly to the electronic circuit of the AC indoor unit and on the other side directly to the KNX bus.

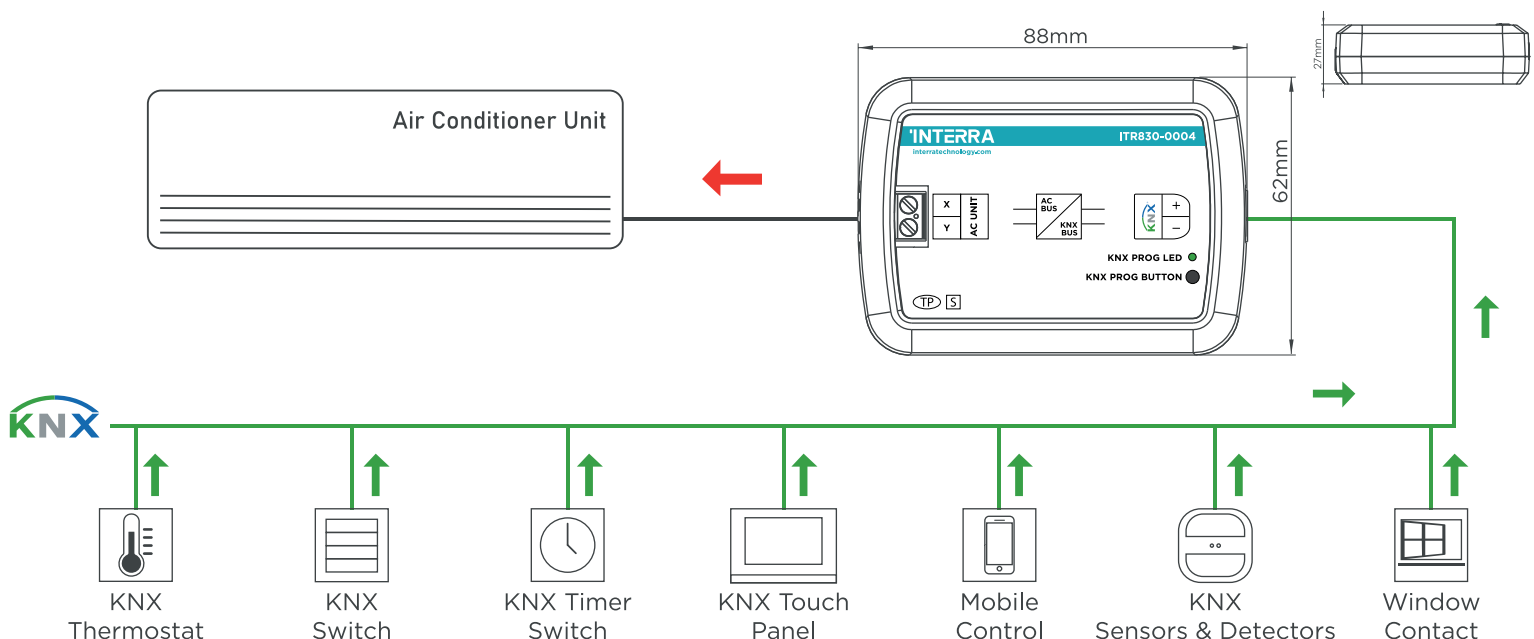

Samsung NASA AC / KNX Gateway

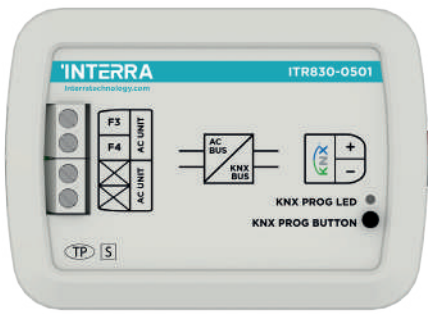

ITR830-05XX

ITR830-0005 is an air conditioner gateway used for monitoring and controlling all the functioning parameters of Samsung NASA air conditioners via the KNX bus line.

FUNCTIONS

- ITR830-05XX can control Samsung air conditioners synchronously with multicast functionality or independent of each other.
- It includes 4 logical advanced parameters, each logical parameter has up to 4 inputs and can be configured as AND, OR & XOR.
- It includes 8 advanced converter parameters and each converter has four operations math calculations according to the input type.
- Logic and converter parameters can be used for energy savings, configurable scenes, temperature limits, etc.
- The Samsung NASA AC - KNX gateway provides error notifications for errors that may occur in exceptional cases.

Technical Specifications

Product Code	ITR830-05XX
Power Supply	KNX Power Supply
Power Consumption	10 mA
Push Buttons	1 x KNX Programming Button
LED Indicators	1 x KNX Programming LED
Type of Protection	IP 20
Cable Distance	Max 300 m
Mode of Commissioning	S-Mode
Maximum Air Humidity	< 90 RH
Temperature Range	Operation (-10°C...70 °C) Storage (-25°C ... 100°C)
Colour	Light Grey
Dimensions	88 x 62 x 27 mm (W x H x D)
Certification	KNX Certified
Configuration	Configuration with ETS

© 2022 INTERRA



OVERVIEW

Samsung NASA AC - KNX Gateway has an easy installation feature and can be installed inside the own AC indoor unit or a proper location away from the air conditioner. It connects one side directly to the electronic circuit of the AC indoor unit and on the other side directly to the KNX bus. In addition, according to the model number, Samsung NASA Gateways can control 1, 1-4, 4-8, 8-16, or 16-32 air conditioners at the same time.

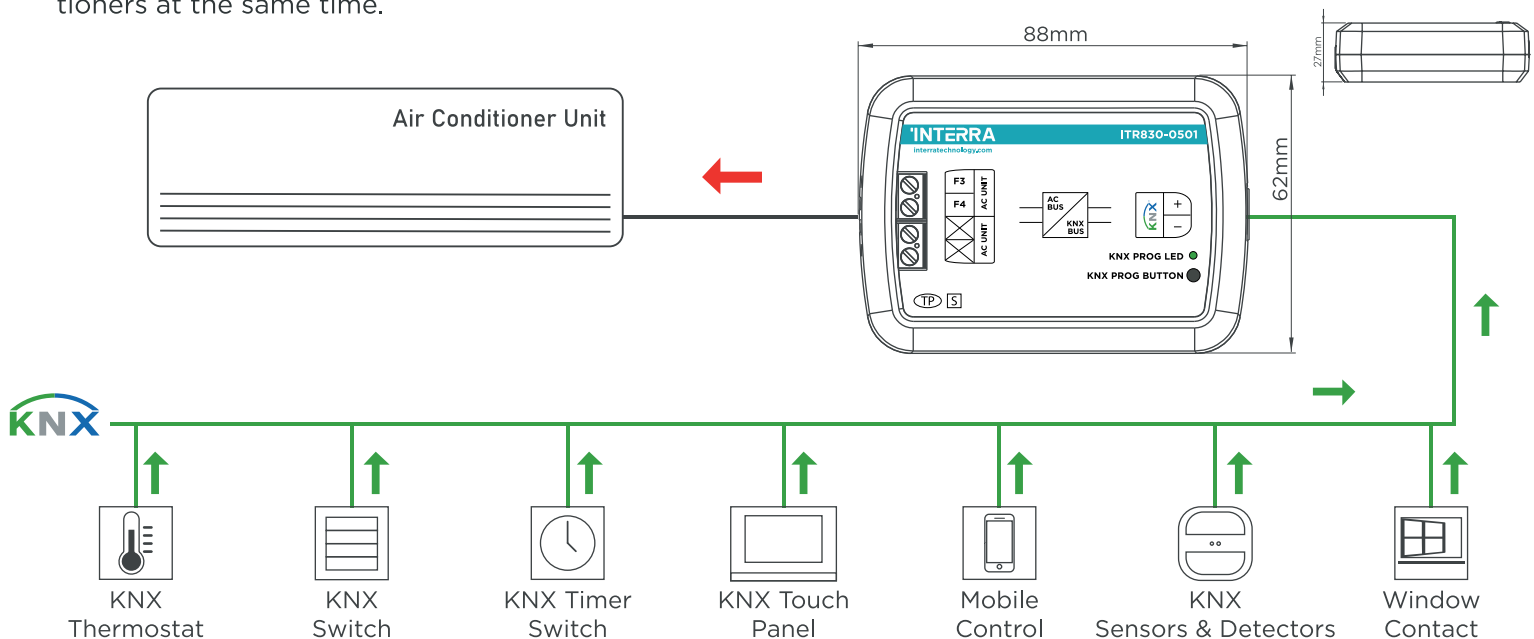

Note: The air conditioner must remain off while at mode transitions between heating and cooling.

For more information visit interratechnology.com

Samsung NASA AC / KNX Gateway

PRODUCT RANGE

- ITR830-0501 - Samsung AC - KNX Gateway 1 Channel - Indoor Unit Type
- ITR830-0504 - Samsung AC - KNX Gateway 1-4 Channel - Indoor Unit Type
- ITR830-0508 - Samsung AC - KNX Gateway 4-8 Channel - Indoor Unit Type
- ITR830-0516 - Samsung AC - KNX Gateway 8-16 Channel - Indoor Unit Type
- ITR830-0532 - Samsung AC - KNX Gateway 16-32 Channel - Indoor Unit Type

CONNECTION DIAGRAM

3 different type connection can be made with Interra Samsung NASA AC / KNX Gateway

The connection chain of air conditioners to be connected to A port and B port should not conflict. Each port must be isolated from the other.

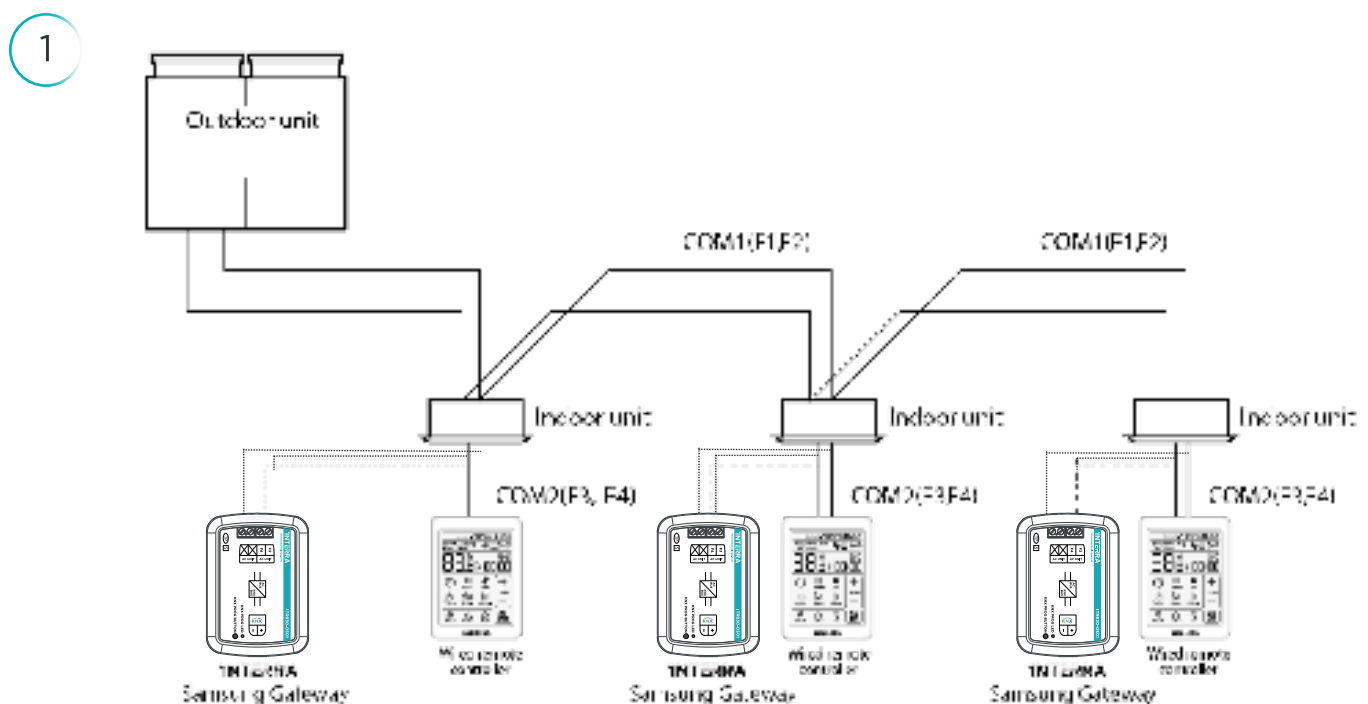

Samsung NASA AC / KNX Gateway

2

The connection chain of air conditioners to be connected to A port and B port should not conflict. Each port must be isolated from the other.

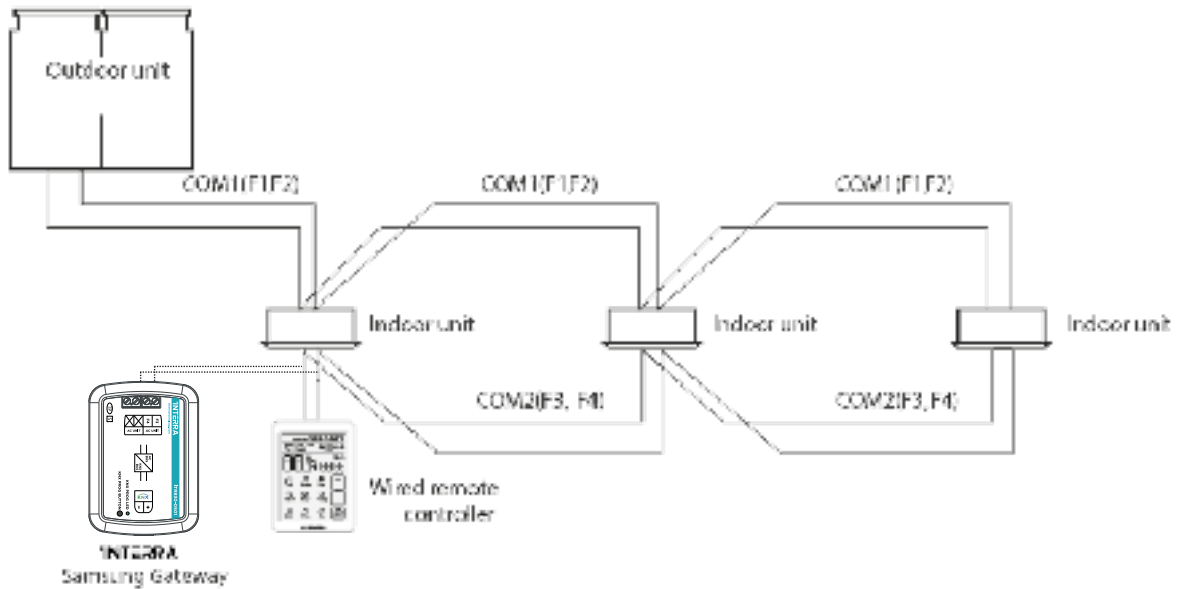

3

The connection chain of air conditioners to be connected to A port and B port should not conflict. Each port must be isolated from the other.

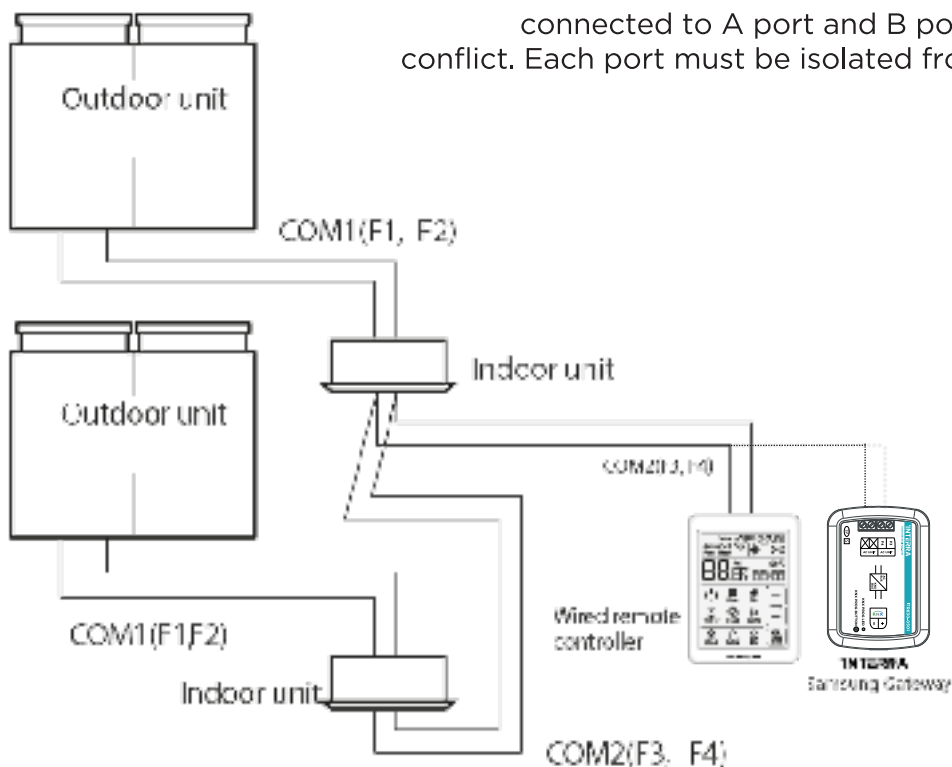

LG AC / KNX Gateway

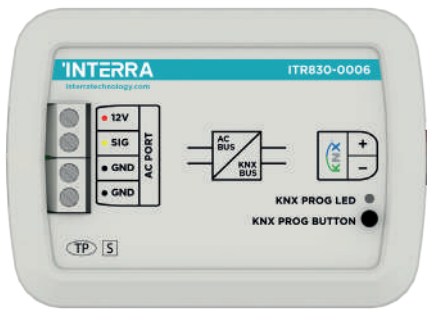

ITR830-0006

ITR830-0006 is an air conditioner gateway used for monitoring and controlling all the functioning parameters of LG air conditioners via the KNX bus line. LG AC - KNX Gateway is compatible with models in single, multi, multi-f, multi-f max, and VRF types categorized in the compatibility list sold by LG.

FUNCTIONS

- ITR830-0006 provides complete bi-directional integration of LG air conditioners with KNX bus.
- It includes 4 logical advanced parameters, each logical parameter has up to 4 inputs and can be configured as AND, OR & XOR.
- It includes 8 advanced converter parameters and each converter has four operations math calculations according to the input type.
- Logic and converter parameters can be used for energy savings, configurable scenes, temperature limits, etc.
- The LG AC - KNX gateway provides error notifications for errors that may occur in exceptional cases.

Technical Specifications

Product Code	ITR830-0006
Power Supply	KNX Power Supply
Power Consumption	5 mA
Push Buttons	1 x KNX Programming Button
LED Indicators	1 x KNX Programming LED
Type of Protection	IP 20
Mode of Commissioning	S-Mode
Maximum Cable Length	50 m
Maximum Air Humidity	< 90 RH
Temperature Range	Operation (0°C ... 40 °C) Storage (-10°C ... 70 °C)
Colour	Light Grey
Dimensions	88 x 62 x 27 mm (W x H x D)
Certification	KNX Certified
Configuration	Configuration with ETS
© 2022 INTERRA	CE KNX ENEC

OVERVIEW

LG AC - KNX Gateway has an easy installation feature and can be installed inside the own AC indoor unit or a proper location away from the air conditioner connects one side directly to the electronic circuit of the AC indoor unit and on the other side directly to the KNX bus. It has 4 different types of connections diagrams which can be found on the datasheet with detailed drawings. (e.i. multi indoor unit control)

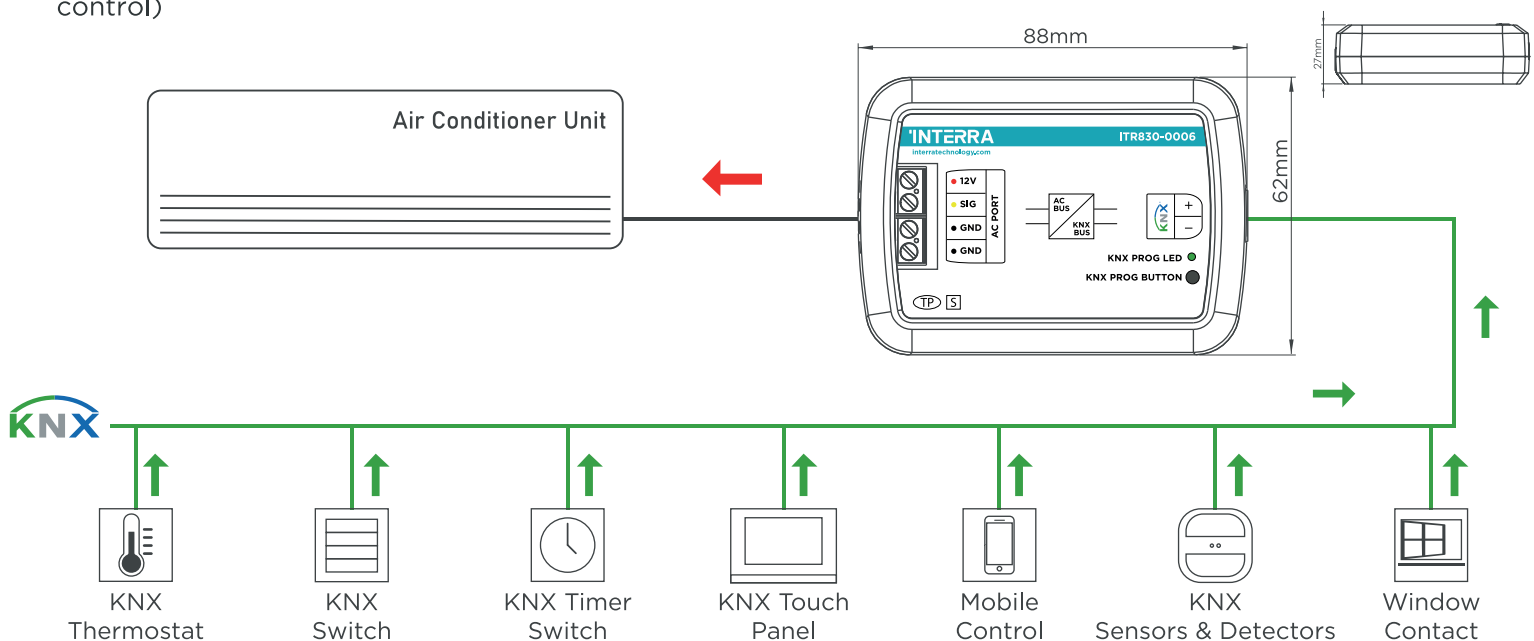

Arçelik AC / KNX Gateway

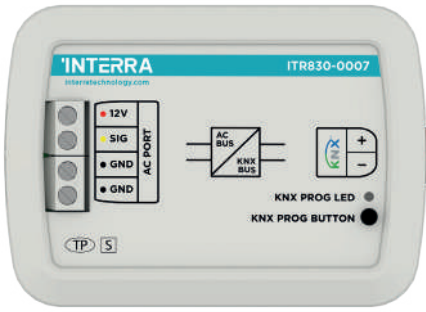

ITR830-0007

ITR830-0007 is an air conditioner gateway used for monitoring and controlling all the functioning parameters of Arçelik air conditioners via the KNX bus line. Arçelik AC - KNX Gateway is compatible with models in several types categorized in the compatibility list sold by Arçelik.

FUNCTIONS

- ITR830-0007 provides complete bi-directional integration of Arçelik air conditioners with KNX bus.
- It includes 4 logical advanced parameters, each logical parameter has up to 4 inputs and can be configured as AND, OR & XOR.
- It includes 8 advanced converter parameters and each converter has four operations math calculations according to the input type.
- Logic and converter parameters can be used for energy savings, configurable scenes, temperature limits, etc.
- The Arçelik AC - KNX gateway provides error notifications for errors that may occur in exceptional cases.

OVERVIEW

Arçelik AC - KNX Gateway has an easy installation feature and can be installed inside the own AC indoor unit or a proper location away from the air conditioner connects one side directly to the electronic circuit of the AC indoor unit and on the other side directly to the KNX bus. It has 4 different types of connections diagrams which can be found on the datasheet with detailed drawings. (e.i. multi indoor unit control)

Technical Specifications	
Product Code	ITR830-0007
Power Supply	KNX Power Supply
Power Consumption	5 mA
Push Buttons	1 x KNX Programming Button
LED Indicators	1 x KNX Programming LED
Type of Protection	IP 20
Mode of Commissioning	S-Mode
Maximum Cable Length	50 m
Maximum Air Humidity	< 90 RH
Temperature Range	Operation (0°C ... 40 °C) Storage (-10°C ... 70 °C)
Colour	Light Grey
Dimensions	88 x 62 x 27 mm (W x H x D)
Certification	KNX Certified
Configuration	Configuration with ETS
© 2022 INTERRA	CE KNX EIB

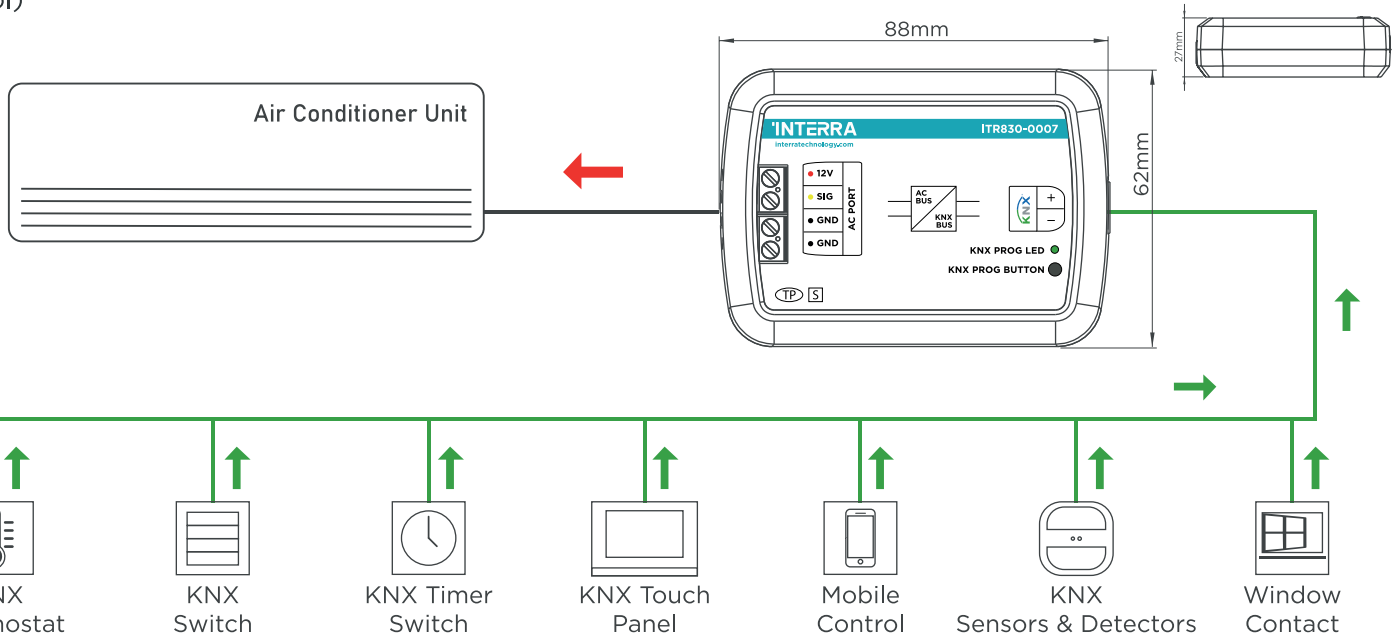

Viessmann Homebus AB Port AC / KNX Gateway

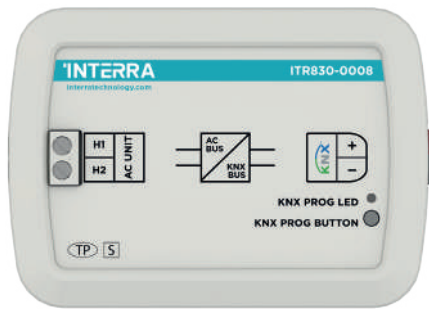

ITR830-0008

ITR830-0008 is an air conditioner gateway used for monitoring and controlling all the functioning parameters of Viessman air conditioners via the KNX bus line. Viessmann Homebus AB Port AC- KNX Gateway is compatible with models in VRF types categorized on the compatibility list sold by Viessman.

FUNCTIONS

- ITR830-0008 device provides complete bi-directional integration of VRF-type air conditioners with KNX bus.
- It includes 4 logical advanced parameters, each logical parameter has up to 4 inputs and can be configured as AND, OR & XOR.
- It includes 8 advanced converter parameters and each converter has four operations math calculations according to the input type.
- Logic and converter parameters can be used for energy savings, configurable scenes, temperature limits, etc.
- The Viessmann AC - KNX gateway provides error notifications for errors that may occur in exceptional cases.

Technical Specifications

Product Code	ITR830-0008
Power Supply	KNX Power Supply
Power Consumption	5 mA
Push Buttons	1 x KNX Programming Button
LED Indicators	1 x KNX Programming LED
Type of Protection	IP 20
Mode of Commissioning	S-Mode
Maximum Air Humidity	< 90 RH
Temperature Range	Operation (-10°C...70 °C) Storage (-25°C ... 100°C)
Colour	Light Grey
Dimensions	88 x 62 x 27 mm (W x H x D)
Certification	KNX Certified
Configuration	Configuration with ETS

© 2022 INTERRA



OVERVIEW

Viessmann Homebus AB Port AC - KNX Gateway has an easy installation feature and can be installed inside the own AC indoor unit or a proper location away from the air conditioner connects one side directly to the electronic circuit of the AC indoor unit and on the other side directly to the KNX bus. It has 4 different types of connections diagrams which can be found on the datasheet with detailed drawings. (e.i. multi indoor unit control)

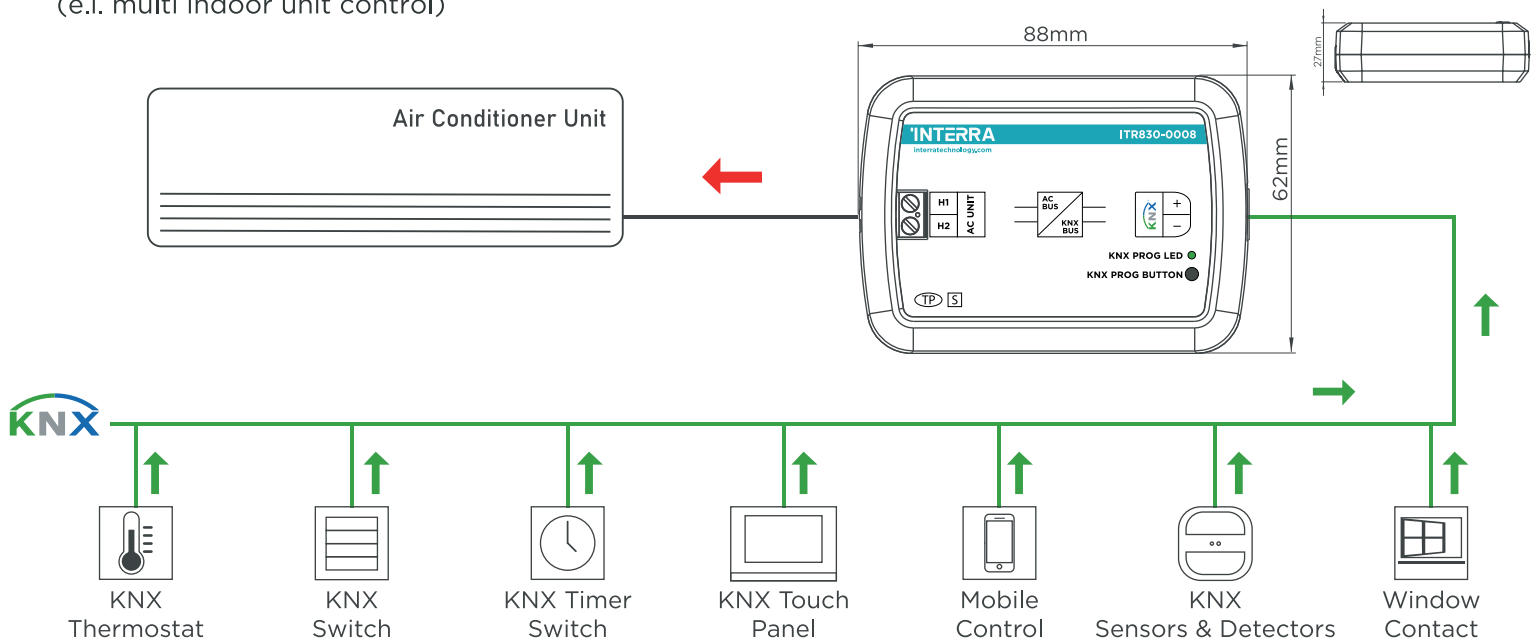

Gree VRF AC / KNX Gateway

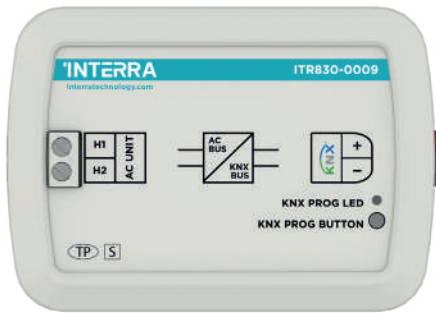

ITR830-0009

ITR830-0009 is an air conditioner gateway used for monitoring and controlling all the functioning parameters of Gree VRF air conditioners via the KNX bus line. Gree VRF AC - KNX Gateway is compatible with models in VRF types categorized in the compatibility list sold by Gree.

FUNCTIONS

- ITR830-0009 provides complete bi-directional integration of Gree VRF air conditioners with KNX bus.
- It includes 4 logical advanced parameters, each logical parameter has up to 4 inputs and can be configured as AND, OR & XOR.
- It includes 8 advanced converter parameters and each converter has four operations math calculations according to the input type.
- Logic and converter parameters can be used for energy savings, configurable scenes, temperature limits, etc.
- The Gree VRF AC - KNX gateway provides error notifications for errors that may occur in exceptional cases.

Technical Specifications

Product Code	ITR830-0009
Power Supply	KNX Power Supply
Power Consumption	5 mA
Push Buttons	1 x KNX Programming Button
LED Indicators	1 x KNX Programming LED
Type of Protection	IP 20
Mode of Commissioning	S-Mode
Maximum Air Humidity	< 90 RH
Temperature Range	Operation (-10°C...70 °C) Storage (-25°C ... 100°C)
Colour	Light Grey
Dimensions	88 x 62 x 27 mm (W x H x D)
Certification	KNX Certified
Configuration	Configuration with ETS

© 2022 INTERRA



OVERVIEW

Gree VRF AC - KNX Gateway has an easy installation feature and can be installed inside the own AC indoor unit or a proper location away from the air conditioner connects one side directly to the electronic circuit of the AC indoor unit and on the other side directly to the KNX bus. It has 2 different types of connections diagrams which can be found on the datasheet with detailed drawings. (e.i. multi indoor unit control)

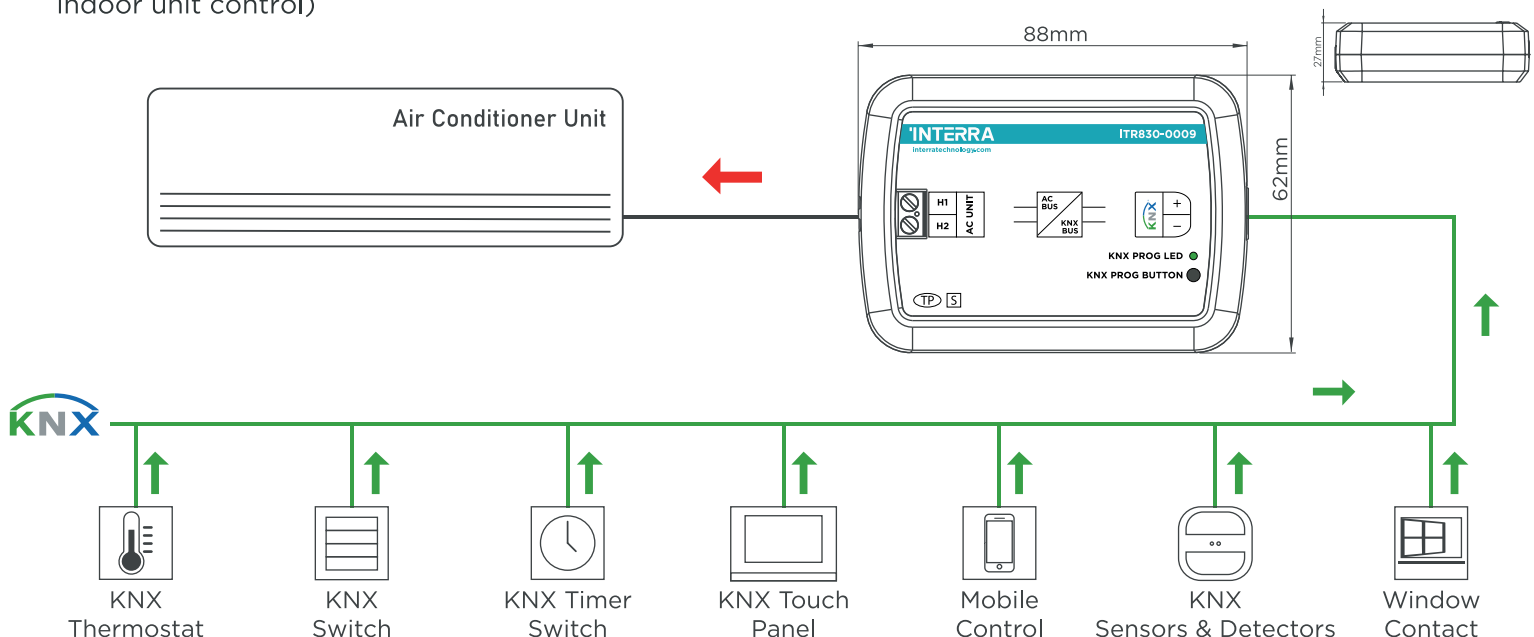

Note: Existing commands may vary according to the indoor unit model. Please refer to relevant technical documents.

For more information visit interratechnology.com

Vaillant AC / KNX Gateway

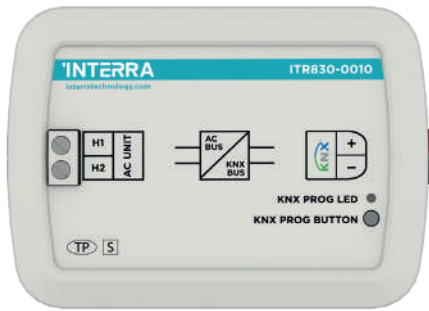

ITR830-0010

ITR830-0010 is an air conditioner gateway used for monitoring and controlling all the functioning parameters of Vaillant air conditioners via the KNX bus line. Vaillant VRF AC - KNX Gateway is compatible with models in VRF types categorized in the compatibility list sold by Vaillant.

FUNCTIONS

- ITR830-0010 provides complete bi-directional integration of VRF type air conditioners with KNX bus.
- It includes 4 logical advanced parameters, each logical parameter has up to 4 inputs and can be configured as AND, OR & XOR.
- Includes 8 advanced converter parameters, each converter has four operations math calculations according to the input type.
- Logic and converter parameters can be used for energy savings, configurable scenes, temperature limits, etc.
- The Vaillant AC - KNX gateway provides error notifications for errors that may occur in exceptional cases.

Technical Specifications

Product Code	ITR830-0010
Power Supply	KNX Power Supply
Power Consumption	5 mA
Push Buttons	1 x KNX Programming Button
LED Indicators	1 x KNX Programming LED
Type of Protection	IP 20
Cable Distance	Max 350 m
Mode of Commissioning	S-Mode
Maximum Air Humidity	< 90 RH
Temperature Range	Operation (-10°C...70°C) Storage (-25°C...100°C)
Colour	Light Grey
Dimensions	88 x 62 x 27 mm (W x H x D)
Certification	KNX Certified
Configuration	Configuration with ETS
© 2022 INTERRA	

OVERVIEW

Vaillant VRF AC - KNX Gateway has an easy installation feature and can be installed inside the own AC indoor unit or a proper location away from the air conditioner connects one side directly to the electronic circuit of the AC indoor unit and on the other side directly to the KNX bus. It has 4 different types of connections diagrams which can be found on the datasheet with detailed drawings. (e.i. multi indoor unit control)

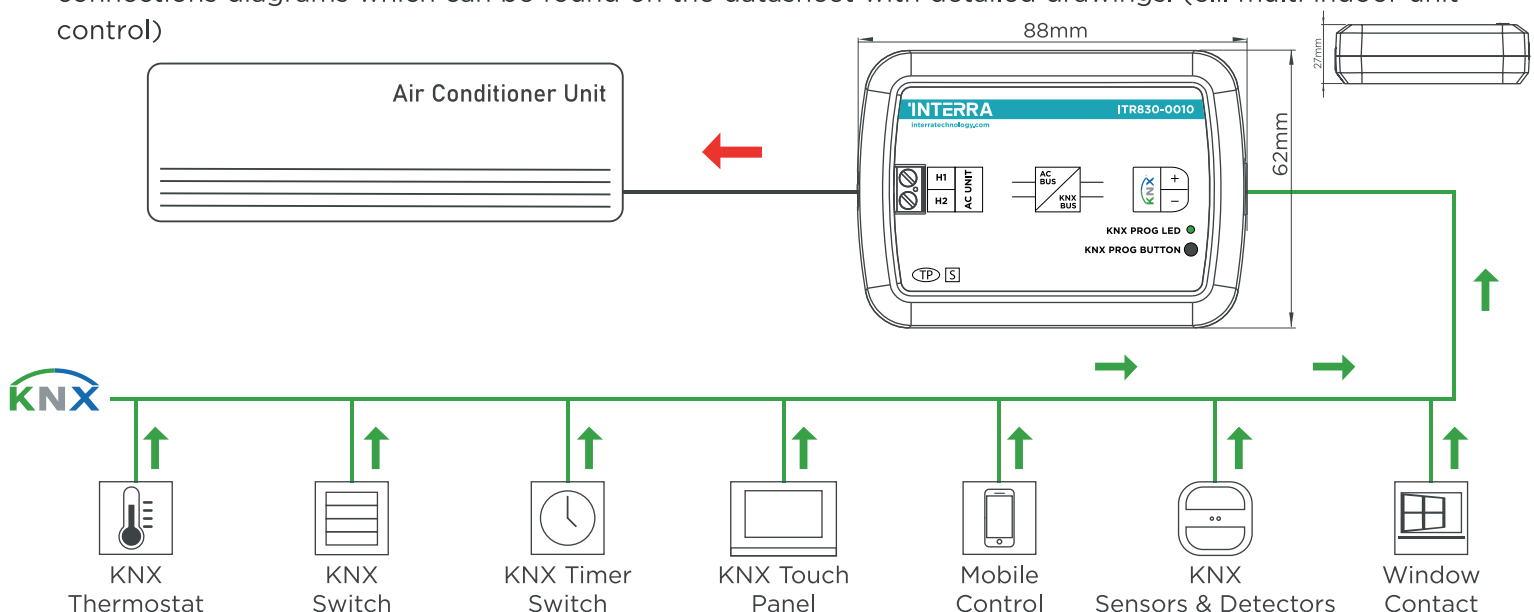

DemirDöküm AC / KNX Gateway

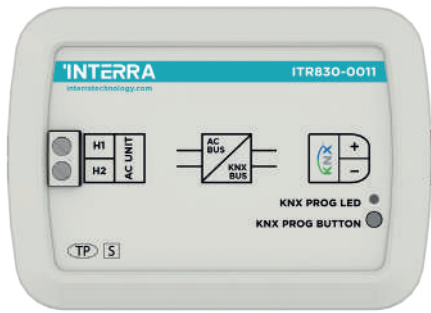

ITR830-0011

ITR830-0011 is an air conditioner gateway used for monitoring and controlling all the functioning parameters of Demirdokum air conditioners via the KNX bus line. Demirdokum VRF AC - KNX Gateway is compatible with models in VRF types categorized in the compatibility list sold by Demirdokum.

FUNCTIONS

- ITR830-0011 provides complete bi-directional integration of VRF type air conditioners with KNX bus.
- It includes 4 logical advanced parameters, each logical parameter has up to 4 inputs and can be configured as AND, OR & XOR.
- Includes 8 advanced converter parameters, each converter has four operations math calculations according to the input type.
- Logic and converter parameters can be used for energy savings, configurable scenes, temperature limits, etc.
- The Demirdokum AC - KNX gateway provides error notifications for errors that may occur in exceptional cases.

Technical Specifications

Product Code	ITR830-0011
Power Supply	KNX Power Supply
Power Consumption	5 mA
Push Buttons	1 x KNX Programming Button
LED Indicators	1 x KNX Programming LED
Type of Protection	IP 20
Cable Distance	Max 350 m
Mode of Commissioning	S-Mode
Maximum Air Humidity	< 90 RH
Temperature Range	Operation (-10°C...70°C) Storage (-25°C...100°C)
Colour	Light Grey
Dimensions	88 x 62 x 27 mm (W x H x D)
Certification	KNX Certified
Configuration	Configuration with ETS
© 2022 INTERRA	CE KNX EIB

OVERVIEW

Demirdokum VRF AC - KNX Gateway has an easy installation feature and can be installed inside the own AC indoor unit or a proper location away from the air conditioner connects one side directly to the electronic circuit of the AC indoor unit and on the other side directly to the KNX bus. It has 4 different types of connections diagrams which can be found on the datasheet with detailed drawings. (e.i. multi indoor unit control)

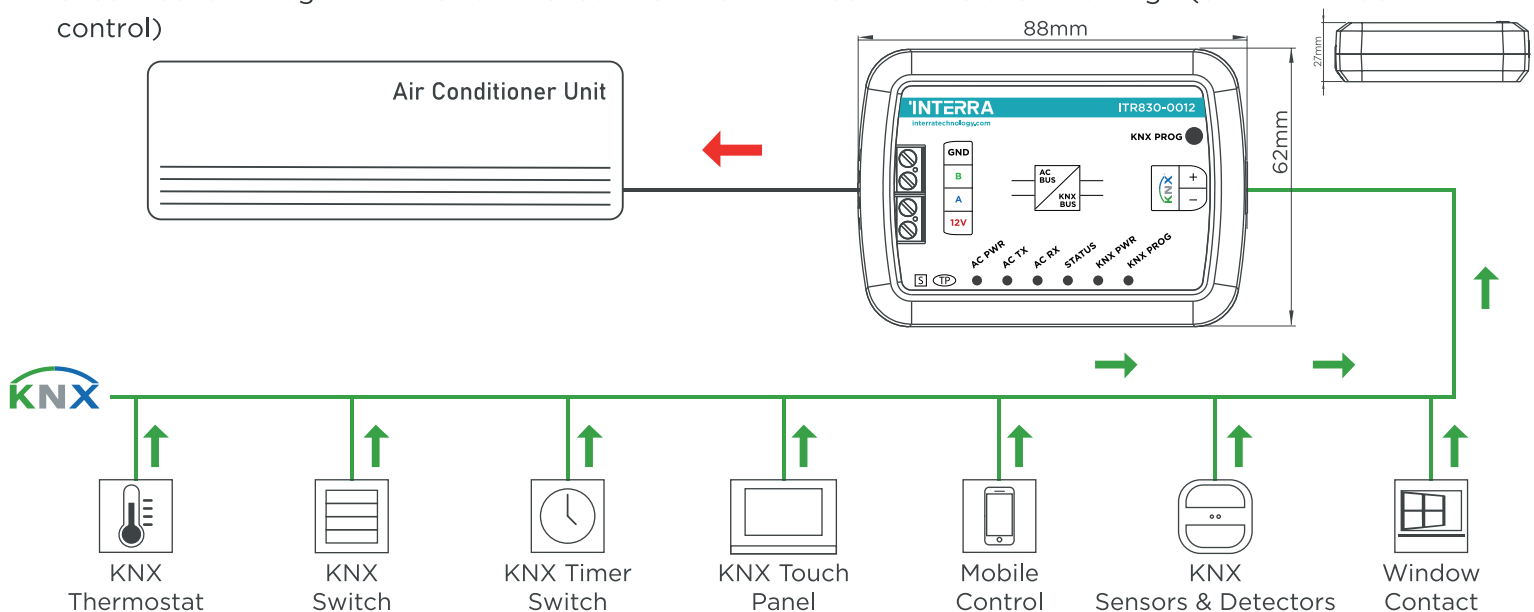

Gree Split AC / KNX Gateway

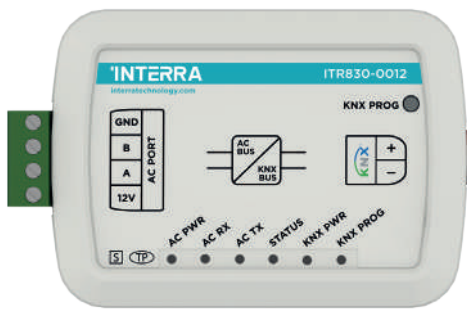

ITR830-0012

ITR830-0012 is an air conditioner gateway used for monitoring and controlling all the functioning parameters of Gree air conditioners via the KNX bus line.

Gree Split AC - KNX Gateway is compatible with models in split types categorized at compatibility list sold by Interra.

FUNCTIONS

- ITR830-0012 provides complete bi-directional integration of Gree Split air conditioners with KNX bus.
- It includes 4 logical advanced parameters, each logical parameter has up to 4 inputs and can be configured as AND, OR & XOR.
- Includes 8 advanced converter parameters, each converter has four operations math calculations according to the input type.
- Logic and converter parameters can be used for energy savings, configurable scenes, temperature limits, etc.
- The Gree AC - KNX gateway provides error notifications for errors that may occur in exceptional cases.

Technical Specifications

Product Code	ITR830-0012
Power Supply	KNX Power Supply
Power Consumption	7 mA
Push Buttons	1 x KNX Programming Button
LED Indicators	1 x KNX Programming LED
Type of Protection	IP 20
Mode of Commissioning	S-Mode
Maximum Air Humidity	< 90 RH
Temperature Range	Operation (-10°C...70 °C) Storage (-25°C ... 100°C)
Colour	Light Grey
Dimensions	88 x 62 x 27 mm (W x H x D)
Certification	KNX Certified
Configuration	Configuration with ETS

© 2022 INTERRA



OVERVIEW

Gree Split AC - KNX Gateway has an easy installation feature and can be installed inside the own AC indoor unit or a proper location away from the air conditioner connects one side directly to the electronic circuit of the AC indoor unit and on the other side directly to the KNX bus.

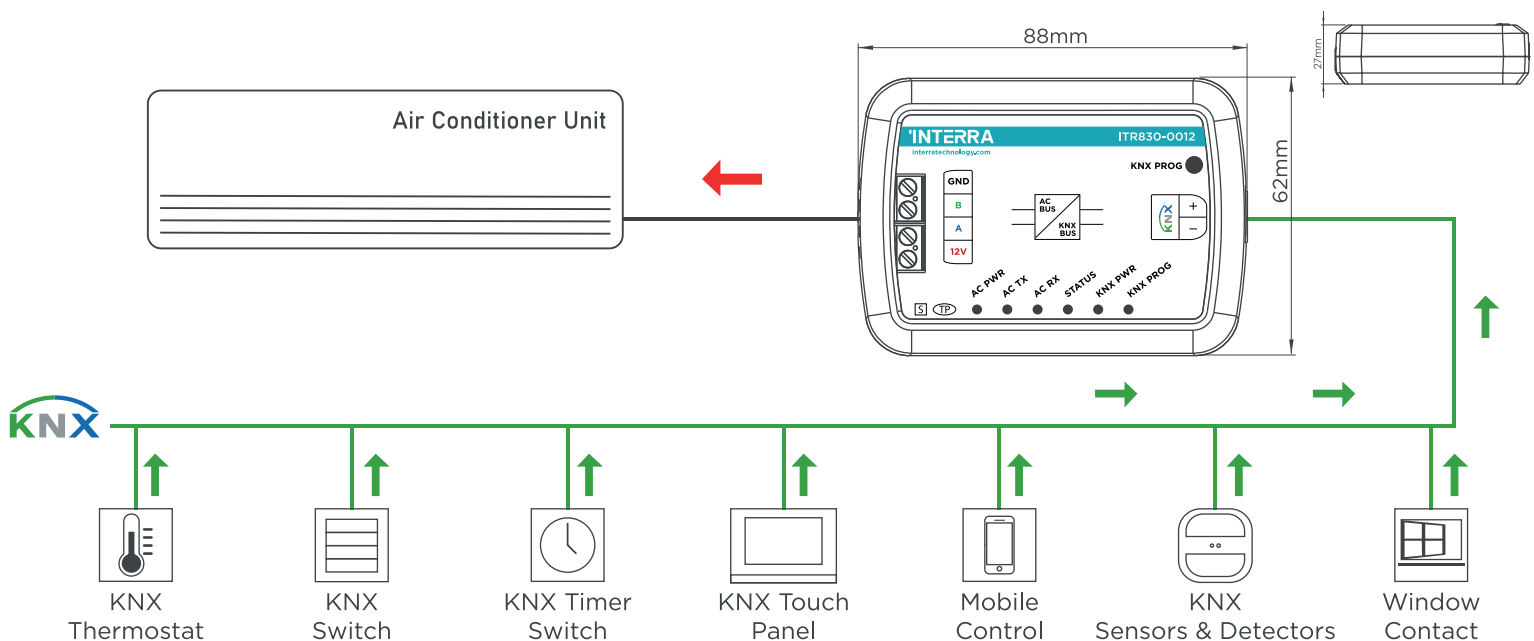

Midea VRF AC / KNX Gateway

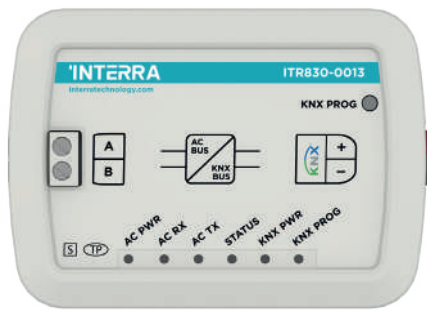

ITR830-0013

ITR830-0013 is an air conditioner gateway used for monitoring and controlling all the functioning parameters of Midea air conditioners via the KNX bus line. Midea VRF AC - KNX Gateway is compatible with models in VRF types categorized on the compatibility list published by Interra.

FUNCTIONS

- ITR830-0013 device provides complete bi-directional integration of VRF type air conditioners with KNX bus.
- Includes 4 logical advanced parameters, each logical parameter have up to 4 inputs and can be configured as AND, OR & XOR.
- Includes 8 advanced converter parameters, each converter has four operations math calculations according to input type.
- Logic and converter parameters can be used for energy savings, configurable scenes, temperature limits etc.
- The Midea air conditioner unit provides error notifications for errors that may occur in exceptional cases.

Technical Specifications

Product Code	ITR830-0013
Power Supply	KNX Power Supply
Power Consumption	5 mA
Push Buttons	1 x KNX Programming Button
LED Indicators	1 x KNX Programming LED
Type of Protection	IP 20
Cable Distance	Max 200 m
Mode of Commissioning	S-Mode
Maximum Air Humidity	< 90 RH
Temperature Range	Operation (-10°C...70°C) Storage (-25°C...100°C)
Colour	Light Grey
Dimensions	88 x 62 x 27 mm (W x H x D)
Certification	KNX Certified
Configuration	Configuration with ETS
© 2022 INTERRA	

OVERVIEW

Midea VRF AC - KNX Gateway has an easy installation feature and can be installed inside the own AC indoor unit or a proper location away from the air conditioner, it connects one side directly to the electronic circuit of the AC indoor unit and in the other side directly to the KNX bus.

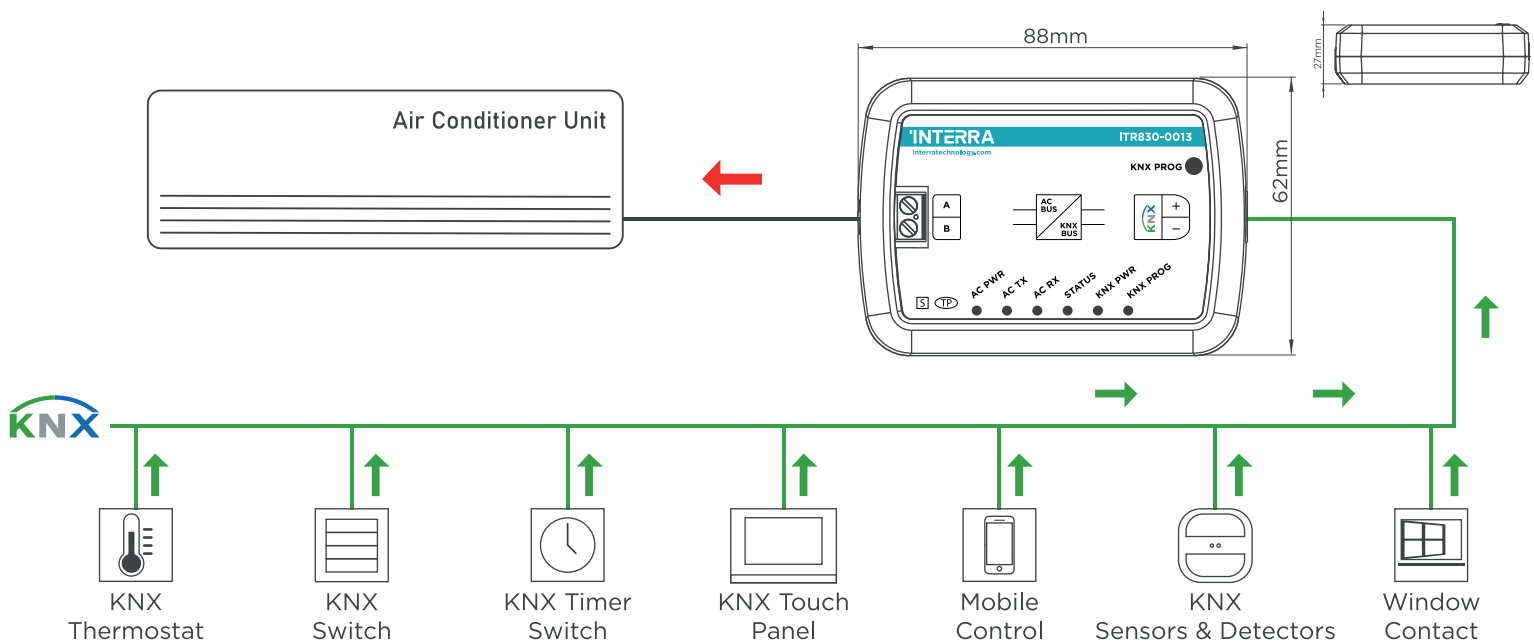

Toshiba VRF AC / KNX Gateway

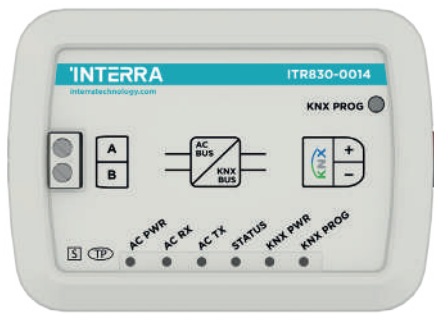

ITR830-0014

ITR830-0014 is an air conditioner gateway used for monitoring and controlling all the functioning parameters of Toshiba air conditioners via the KNX bus line. Toshiba VRF AC - KNX Gateway is compatible with models in VRF types categorized on the compatibility list published by Interra.

FUNCTIONS

- ITR830-0014 device provides complete bi-directional integration of VRF type air conditioners with KNX bus.
- Includes 4 logical advanced parameters, each logical parameter have up to 4 inputs and can be configured as AND, OR & XOR.
- Includes 8 advanced converter parameters, each converter has four operations math calculations according to input type.
- Logic and converter parameters can be used for energy savings, configurable scenes, temperature limits etc.
- The Toshiba air conditioner unit provides error notifications for errors that may occur in exceptional cases.

Technical Specifications

Product Code	ITR830-0014
Power Supply	KNX Power Supply
Power Consumption	3,3 mA
Push Buttons	1 x KNX Programming Button
LED Indicators	1 x KNX Programming LED
Type of Protection	IP 20
Cable Distance	Max 150 m
Mode of Commissioning	S-Mode
Maximum Air Humidity	< 90 RH
Temperature Range	Operation (-10°C...70°C) Storage (-25°C...100°C)
Colour	Light Grey
Dimensions	88 x 62 x 27 mm (W x H x D)
Certification	KNX Certified
Configuration	Configuration with ETS
© 2022 INTERRA	

OVERVIEW

Toshiba VRF AC - KNX Gateway has an easy installation feature and can be installed inside the own AC indoor unit or a proper location away from the air conditioner, it connects one side directly to the electronic circuit of the AC indoor unit and in the other side directly to the KNX bus.

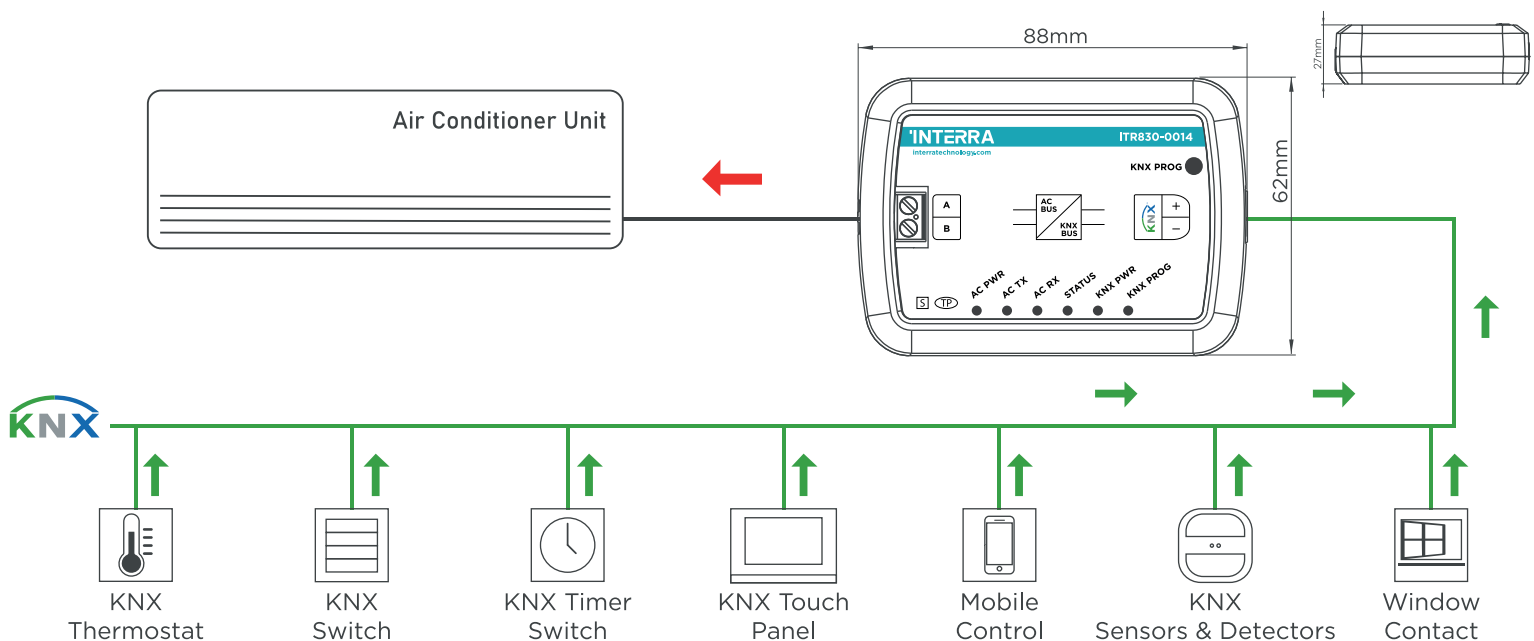

Viessmann Split AC / KNX Gateway

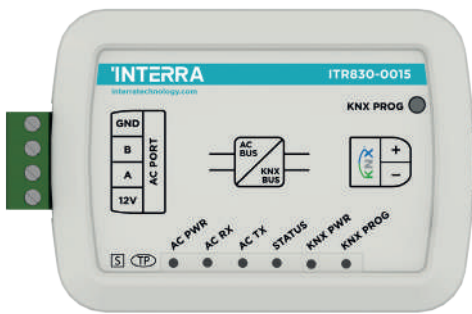

ITR830-0015

ITR830-0015 is an air conditioner gateway used for monitoring and controlling all the functioning parameters of Viessman air conditioners via the KNX bus line. Viessman Split AC - KNX Gateway is compatible with models in split types categorized on the compatibility list sold by Interra.

FUNCTIONS

- ITR830-0015 device provides complete bidirectional integration of Viessman Split air conditioners with KNX bus.
- Includes 4 logical advanced parameters, each logical parameter has up to 4 inputs and can be configured as AND, OR & XOR.
- Includes 8 advanced converter parameters, each converter has four operations math calculations according to the input type.
- Logic and converter parameters can be used for energy savings, configurable scenes, temperature limits, etc.
- The Viessman air conditioner unit provides error notifications for errors that may occur in exceptional cases.

Technical Specifications

Product Code	ITR830-0015
Power Supply	KNX Power Supply
Power Consumption	7 mA
Push Buttons	1 x KNX Programming Button
LED Indicators	1 x KNX Programming LED
Type of Protection	IP 20
Cable Distance	Max 350 m
Mode of Commissioning	S-Mode
Maximum Air Humidity	< 90 RH
Temperature Range	Operation (-10°C...70°C) Storage (-25°C...100°C)
Colour	Light Grey
Dimensions	88 x 62 x 27 mm (W x H x D)
Certification	KNX Certified
Configuration	Configuration with ETS
© 2022 INTERRA	

OVERVIEW

Viessman Split AC - KNX Gateway has an easy installation feature and can be installed inside the own AC indoor unit or a proper location away from the air conditioner, it connects one side directly to the electronic circuit of the AC indoor unit and in the other side directly to the KNX bus.

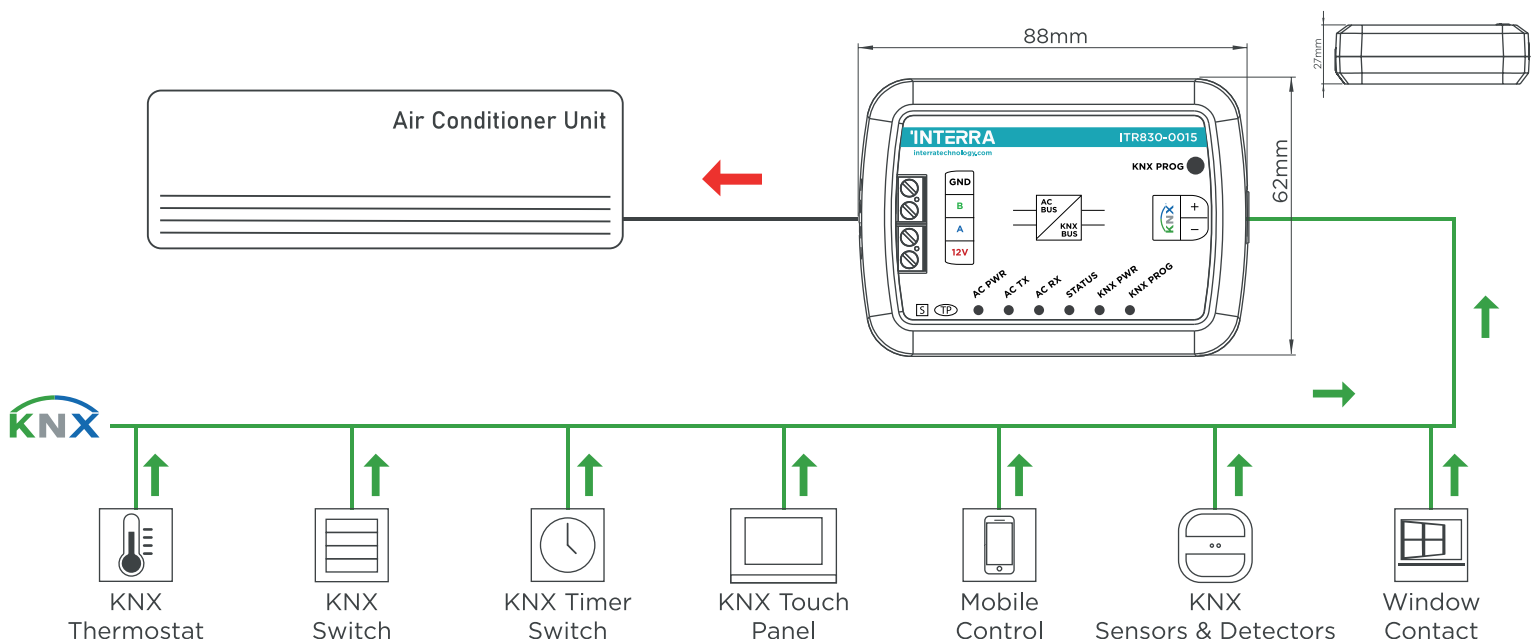

INTERRA

Developer of Uniqueness

Cumhuriyet Mh. Kartal Cd. Interra R&D Center
Kartal / Istanbul - Turkey

T: +90 216 326 26 40
F: +90 216 324 25 03
E: info@interra.com.tr

interratechnology.com

Easiest way to monitor and control
the air conditioning systems.

Interra KNX / AC Gateways provided
complete and reliable integration in
thousands of KNX projects globally.



Ataköy Sea Pearl - Istanbul



Yedi Mavi Residence - Istanbul



The Harrington Collection - Australia



Vadi Istanbul Mall & Office & Residence



Acar Kent Villas - Istanbul



Merkez Ankara



Mesa Orman - Istanbul



Hilton Dalaman Lake Houses - Muğla



Nevbahar Üsküdar - Istanbul



Denli Lujo Villas - Tekirdağ



Çengelköy Park - Istanbul



Invictus Sunset Ilıca - Izmir



Nidapark İstinye - Istanbul



Avrupa Konutları Çamlı Vadi - Istanbul



Invictus Alaçatı Port - Izmir



G Beyond Residence & Villas - Bodrum



Lalila Blue Suites - Marmaris



Izmir Chamber Of Commerce



Referans Başakşehir - Istanbul



Yamanevler - Istanbul



Bahçeşehir Konakları - Istanbul



Bitez Mansions - Bodrum



Istanbul Hisar Educational Institution



Bahçeşehir Park - Istanbul