

INTERRA

— Developer of Uniqueness —

i7+ Touch Panel

Product Manual



Contents

1. CONTENT OF THE DOCUMENT	6
2. PRODUCT DESCRIPTION	7
2.1. Technical Information	8
2.2. Dimensions.....	9
2.3. Mounting.....	10
2.4. Connection Diagram.....	11
2.5. Functionality	12
2.6. Installation.....	13
2.7. Start-Up	13
2.8. Configuration	13
2.8.1. Installation of Interra Configurator App	13
3. MAIN SCREEN (DASHBOARD)	14
3.1. Status Bar	15
3.2. Information Bar	16
3.3. Menu Bar	17
3.4. Shortcut Bar.....	18
4. LIGHTING	19
5. CURTAIN	21
6. BLIND	23
7. AIR CONDITION	25
8. GENERAL	27
9. SCHEDULE	28
9.1. Create Schedule.....	30
9.1.1. Define Schedule	30
9.1.2. Add Schedule Process	31
9.1.2.1. Add Activity	32
9.1.3. Add Schedule Time	35
10. SCENARIO	39
10.1. Create Scenario	40
10.1.1. Define Scenario	40
10.1.2. Add Scenario Process	41
10.1.2.1. Add Activity	42
11. SERVICES	44
12. ALARM	45
13. CONTACT	48

14. CAMS.....	51
15. SITE MANAGEMENT	52
16. MESSAGES.....	53
17. SETTINGS MENU	54
17.1. Dashboard	54
17.2. Settings	54
17.2.1. General	55
17.2.1.1. Language	56
17.2.1.2. Door Bell	57
17.2.1.3. Sip Ring	58
17.2.1.4. Date Info	59
17.2.1.5. Time Info	62
17.2.1.6. Screen Saver	64
17.2.1.7. Screen Saver Delay	65
17.2.1.8. Screen Saver Brightness	66
17.2.1.9. Use Screen Saver Password	67
17.2.1.10. Screen Saver Password	68
17.2.1.11. Admin Password	69
17.2.1.12. Volume Level	70
17.2.2. Info	71
17.2.3. Network	72
17.2.4. Alarm Passwords	73
17.2.5. Door Bell	74
17.3. Theme	75
17.4. Connections	76
17.5. About	79
17.6. Help	79
17.7. Diagnostic	80
17.8. Close	80
17.9. Reboot.....	80

Information contained in this publication regarding device applications and the like is provided only for your convenience and may be superseded versions by updates. It is your responsibility to ensure that your application meets your specifications.

INTERRA MAKES NO REPRESENTATIONS OR WARRANTIES OF ANY KIND WHETHER EXPRESS OR IMPLIED, WRITTEN OR ORAL, STATUTORY OR NONSTATUTORY, RELATED TO THE INFORMATION INCLUDING BUT NOT LIMITED TO ITS CONDITION, QUALITY, PERFORMANCE, MERCHANTABILITY OR FITNESS FOR PURPOSE.

Interra disclaims all liability arising from this information and its use. Use of Interra devices in life support and/or safety applications is entirely at the buyer's risk, and the buyer agrees to defend, indemnify and hold harmless Interra from any damages, claims, suits, or expenses resulting from such use. Under any Interra intellectual rights, no licences are conveyed implicitly or otherwise.

Trademarks

The Interra name, logo and the Interra ITR165-0002 - i7+ Touch Panel devices are registered trademarks of Interra Technology in Turkey and other countries.

All other trademarks mentioned herein are property of Interra Technology.

©2022, Interra, Printed in Turkey, All Rights Reserved.



Printed on recycled paper.

TS EN ISO 9001:2008

TO OUR CUSTOMERS

One of our most important aims is to provide you with the best documentation possible to use successfully your Interra products. Focusing on this, we will keep on improving our documentation to better suit your needs. Our publications will be updated as new volumes as soon as changes are introduced.

If you have any questions or comments regarding this publication, do not hesitate to contact us:

E-Mail : info@interra.com.tr

Tel: +90 (216) 326 26 40 Fax: +90 (216) 324 25 03

Most Current Product Manual

To obtain the most up-to-date version of this product manual, please visit our Web site at:

<http://www.interratechnology.com>

You can determine the version of an Interra document by examining its literature number found on the bottom right corner of any page.

The first two letters of the literature are the type of document. The numbers that follow are the document's creation date and the last letter is the version (e.g., PM221017001A is the version A of a product manual created on the date 17/10/22).

1. Content of The Document

This document contains Interra ITR165-0002 coded i7+ Touch Panel devices' electronic and all essential feature information for programming the products. Each subtitle has explained the characteristics of the device. Modifications of the product and special change requests are only allowed in coordination with product management.

This manual provides detailed technical information concerning ITR165-0002 i7+ Touch Panel. All the models have the same software functionality so, the features described in this document apply to all versions.

This user manual is intended for use by KNX installers and describes the functions and parameters of the Interra Touch Panel family devices and how it is possible to change the settings and configurations using the Interra Configurator. This document also describes the installation, programming, commissioning and use of the devices with detailed information.

2. Product Description

ITR165-0002 series i7+ Touch Panel devices are the newest products of Interra Technology. The i7+ Touch Panels are designed for use in the main interior areas of buildings. i7+ Touch Panels are designed to control the entire automation system from a single smart point. i7+ Touch Panels can control complex systems such as switches, simple sensors, lighting, heating systems, camera and alarm systems from a central point.

Mobile control can be done by downloading Interra Pro software from online software markets related to IOS or Android-based devices. The configuration software (Interra Configurator) can be downloaded from our website (www.interratechnology.com) for the Interra Touch Panel Configuration.

With i7+ Touch Panel, the house can be controlled via voice command assistants such as Siri.

2.1. Technical Information

The following table shows the technical information of the i7+ Touch Panel.

Device	i7+ Touch Panel
Product Code	ITR165-0002
Power Supply	12 V – 2 A DC Power Supply
CPU	ARM Cortex A7 Dual Core 2 x 1.2 GHz
Memory	1 GB DDR3
Storage	8 GB EMMC
OS	Android
USB	1 x USB2.0
KNX	1 x KNX Connector
Sensors	1 x Temperature Sensor
Display	7" LCD, HDMI 1.3 up to 1920 x 1080p @60 Hz
Network	100 Mbps Ethernet and USB WIFI
RTC	The system includes RTC with a CR1220 battery
GPIO	3pcs relayed Output (5 A), 3pcs input connectors
Operation Temperature	-20°C...70°C
Storage Temperature	-35°C...100°C
Dimensions	170 x 65 x 90 mm (W x H x D)
Certification	KNX Certified
Configuration	With Interra Configurator Software

2.2. Dimensions

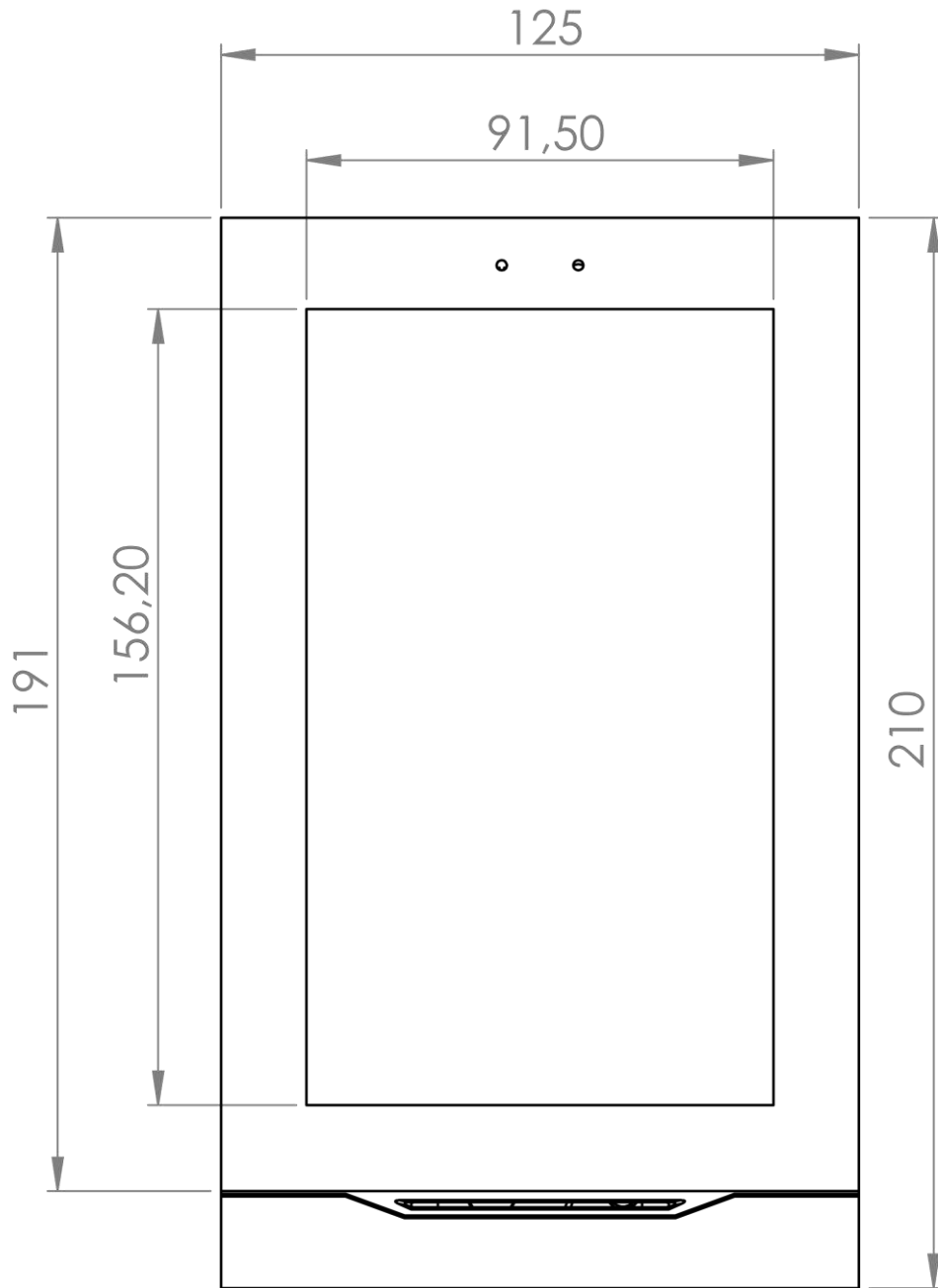

Fig. 1 : Dimensions of all described device types

2.3. Mounting

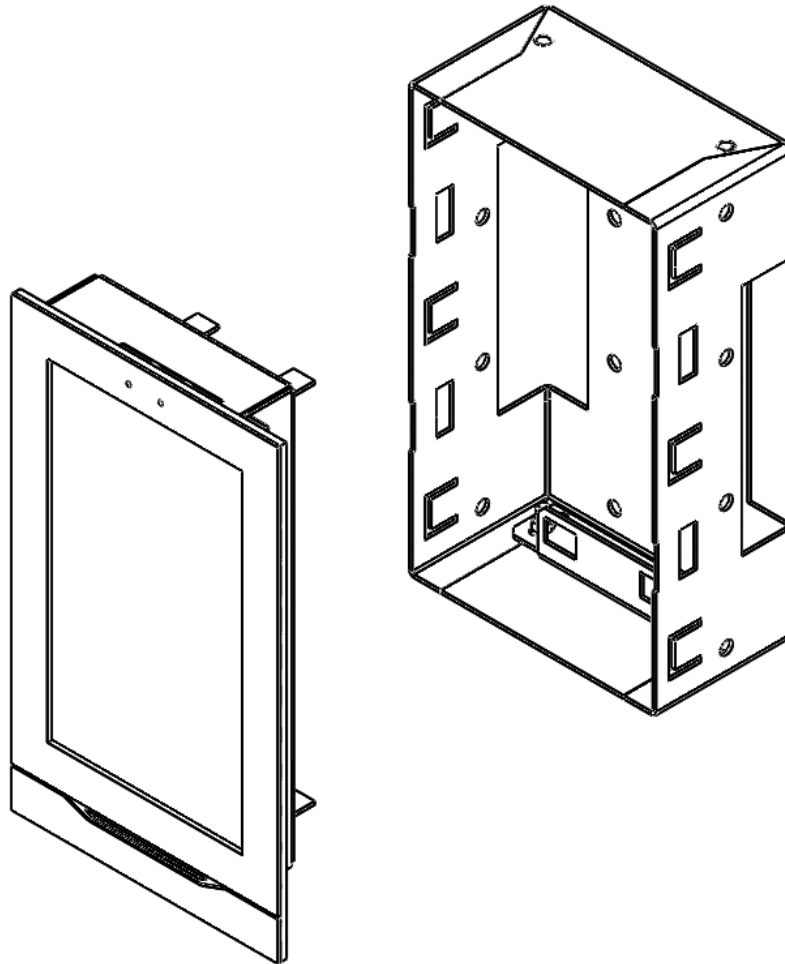

Fig. 2 : Mounting

- I. First, the mounting box must be attached to a suitable place on the wall. The long side of the mounting box should be placed at a right angle to the ground.
- II. Then i7+ is attached to the mounting box as shown in the left figure and the mounting process is completed.

2.4. Connection Diagram

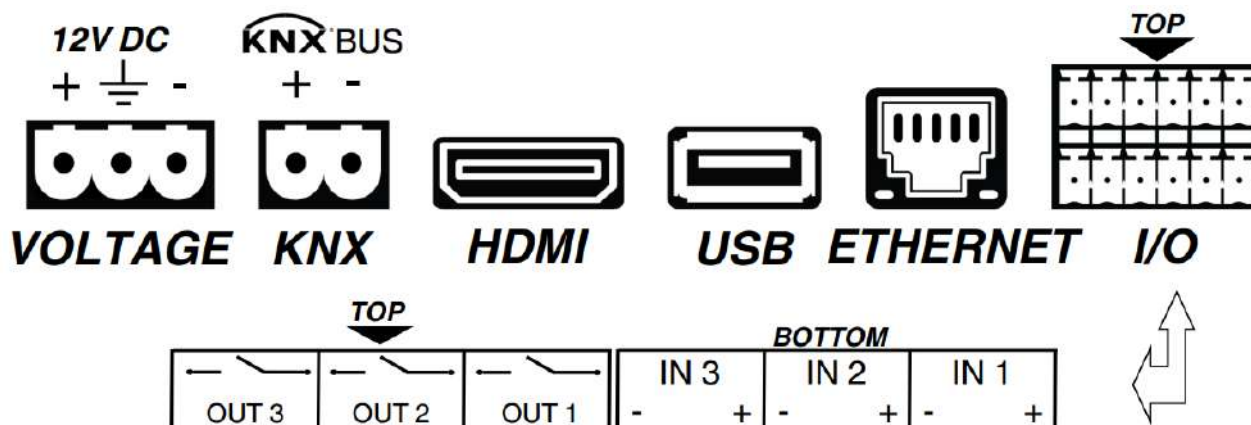

Fig. 3 : Connectors

Voltage : Interra i7+ is powered by a special 3-pin green industrial special connector with 12 V – 2 A DC voltage. Pin indications are written on the plastic case. The cables of the 12 V power supply must be plugged following the polarity.

KNX : Interra i7+ has a two-pin green coloured KNX connector. This connector has pin indications on the plastic box. KNX cables must be plugged into this connector with the correct polarity.

HDMI : Interra Touch Panels have an HDMI connector for different application purposes. Its output is configurable via special software.

USB : i7+ has a USB host connector on the side panel. This connection extends its storage capacity. Also, this connector can be used for a Wi-Fi connection via a USB dongle.

Ethernet : i7+ has a standard 10/100 Mbps RJ45 ethernet connector.

I/O : i7+ has 3 inputs and 3 outputs connectors. Both inputs and outputs are optocoupled. Outputs are connected to ~12 V-5 A relays.

2.5. Functionality

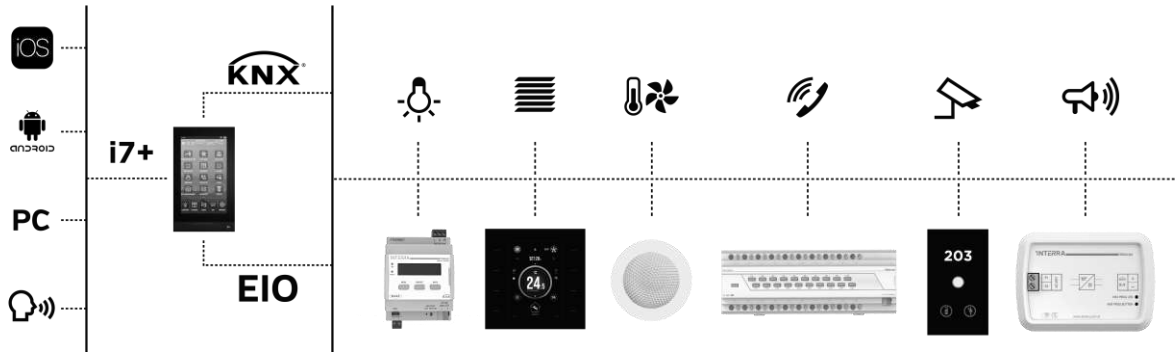

Fig. 4 : Diagram

- ✓ The automation system via EIO (Ethernet Input / Output) and KNX can be controlled with the i7+ Touch Panel.
- ✓ Via the i7+ touch panel's timer feature, desired operations can be made according to daily, weekly, monthly, annual or determined schedules.
- ✓ Security systems can be controlled via mobile and panel applications and also available cameras can be displayed with i7+.
- ✓ The desired number of logic operations can be made with i7+.
- ✓ Push notifications to mobile applications are immediately sent in the event of notification via Google and Apple Cloud.
- ✓ All IOT compatible devices can be controlled using the Interra touch panel.
- ✓ With the i7+, the house can be controlled via voice command assistants such as Siri.

2.6. Installation

Interra i7+ Touch Panel is connected to the KNX bus through the built-in terminal. An external DC power supply (12 V) that delivers at least 800 mA of current is also required. The KNX power and the external power must be provided by separate supplies, to avoid interference to the KNX bus. This external power must be supplied to the device through the corresponding terminal provided within the original packaging.

For detailed information about the technical features of Interra Touch Panels, as well as on security and installation procedures, please refer to the device Datasheet, bundled within the device packaging and also available at www.interratechnology.com

2.7. Start-Up

After installing the device and connecting the bus line, power supply and Ethernet, the device can be started up.

2.8. Configuration

Configuration the Interra i7+ Touch Panel via the Interra Configurator app.

2.8.1. Installation of Interra Configurator App

The configuration software (Interra Configurator) can be downloaded from our website (www.interratechnology.com) for i7+ Touch Panel configuration.

3. Main Screen (Dashboard)

The user interface that you can see in the image below is the touch panel homepage. This interface consists of 4 areas. These are the status bar, information bar, menu bar, shortcut bar and settings menu section.



Fig. 5 : Main Screen

NUMBER	PART NUMBER	NAME
1	3.1	Status Bar
2	3.2	Information Bar
3	3.3	Menu Bar
4	3.4	Shortcut Bar
5	17	Settings Menu Section

3.1. Status Bar

In the status bar section, the version number of the panel user interface program is in the upper left corner. Also, the network connection status is shown by the wi-fi icon in the upper right corner.



Fig. 6 : Status Bar

NUMBER	NAME
1	Version
2	Notifications
3	KNX Status

- 1 This part shows the version of the device.

- 2 Notifications are shown in this part.

- 3 KNX Connection Status is shown in this part.

3.2. Information Bar

In the Information bar section, date, time and day information, weather temperature and weather information in the current region, project name and location information can be accessed.

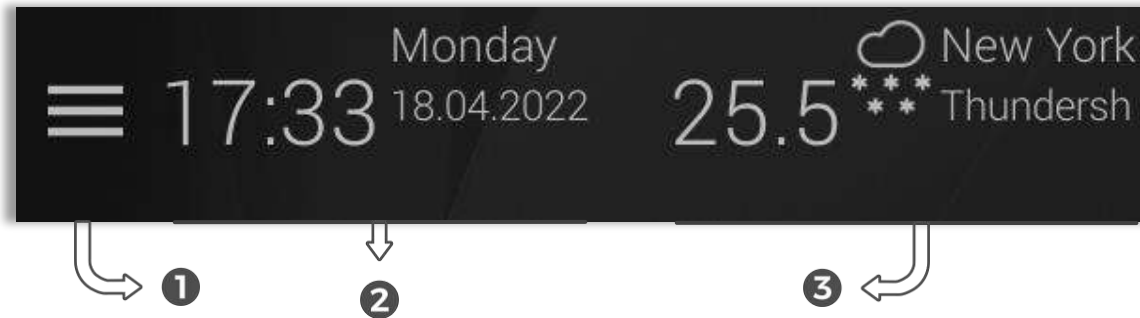

Fig. 7 : Information Bar

NUMBER	NAME
1	Settings Menu
2	Time and Calendar
3	Weather Condition

You can follow instant information from this constantly updated section. In addition, there are 2 user interface buttons in this bar. The functions of the buttons are described below:

- 1 This touch button is used to access the settings menu. This section includes theme changes, linked mobile users, etc. You can access the information and make the desired changes. The submenus for the settings menu are described in the following sections.
- 2 The time and date are displayed in this section.
- 3 Information about the current location's weather is displayed here.

3.3. Menu Bar

In the menu section, location-based building automation controls, scenarios, alarms, services, communication, cameras, site management, messages, timer operations etc. can be performed.

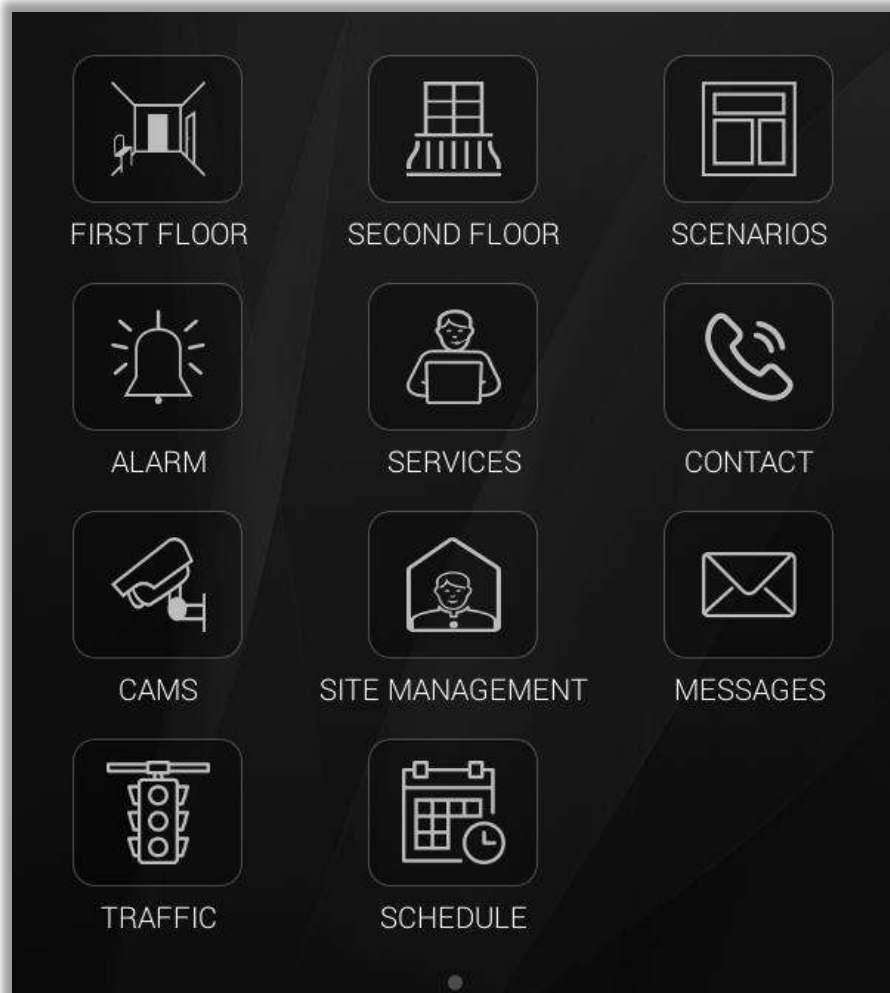

Fig. 8 : Menu Bar

You can access the related sub-sections by using the touch buttons that represent the operations on this screen.

3.4. Shortcut Bar

In the shortcuts section, lighting, curtains, blinds, air conditioning and general controls can be made.

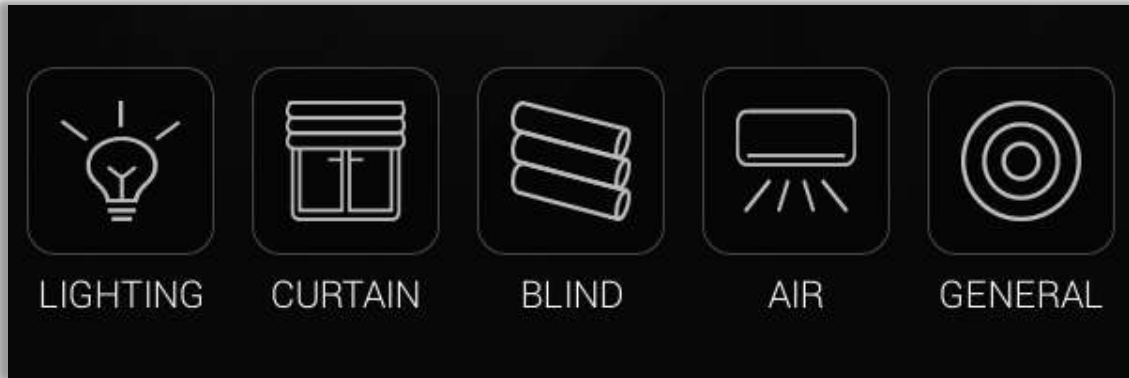

Fig. 9 : Shortcut Bar

Using these touch buttons, you can access the locations where the controls are defined from the shortcut and control the devices.

4. Lighting

When the touch illumination icons are pressed, illumination occurs on the relevant visual object and the lamp turns on. When you want to turn off the lamp, you must touch the same icon again. When the lamp turns off, the illumination of the visual object will also fade. Dimmer lighting, which is used for adjusting the light with a certain brightness, can be controlled as a percentage as well as on / off control. You can set the desired level of light brightness with the status bar located under the Dimmer object.

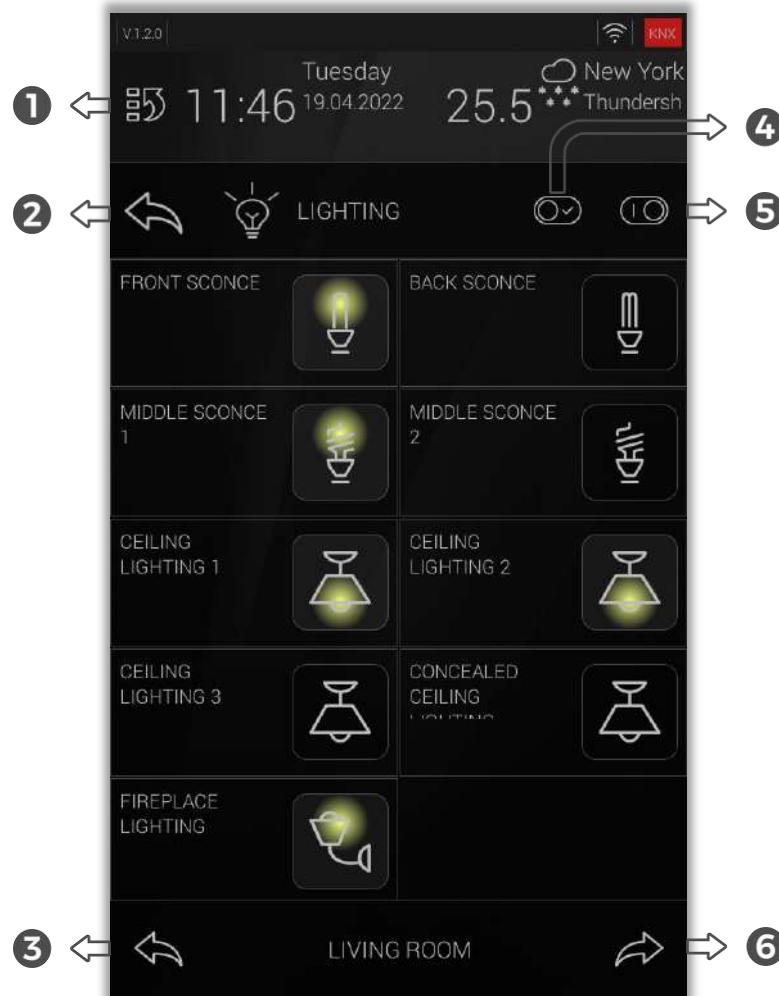

Fig. 10 : Lighting Section

Touch buttons that can be used in the lighting section are described below:

- 1 This touch button is used to return to the home page. It is used for the same purpose in different sub-menus.
- 2 This touch button is used to return to the previous parent page.
- 3 This touch button is used to move to the back location.

- 4 This touch button is used to turn on all the lighting in the relevant area.
- 5 This touch button is used to turn off all the illumination at the relevant location.
- 6 This touch button is used to move to the next location.

5. Curtain

Curtains defined in the relevant area can be controlled individually or all at once from this Curtain section.

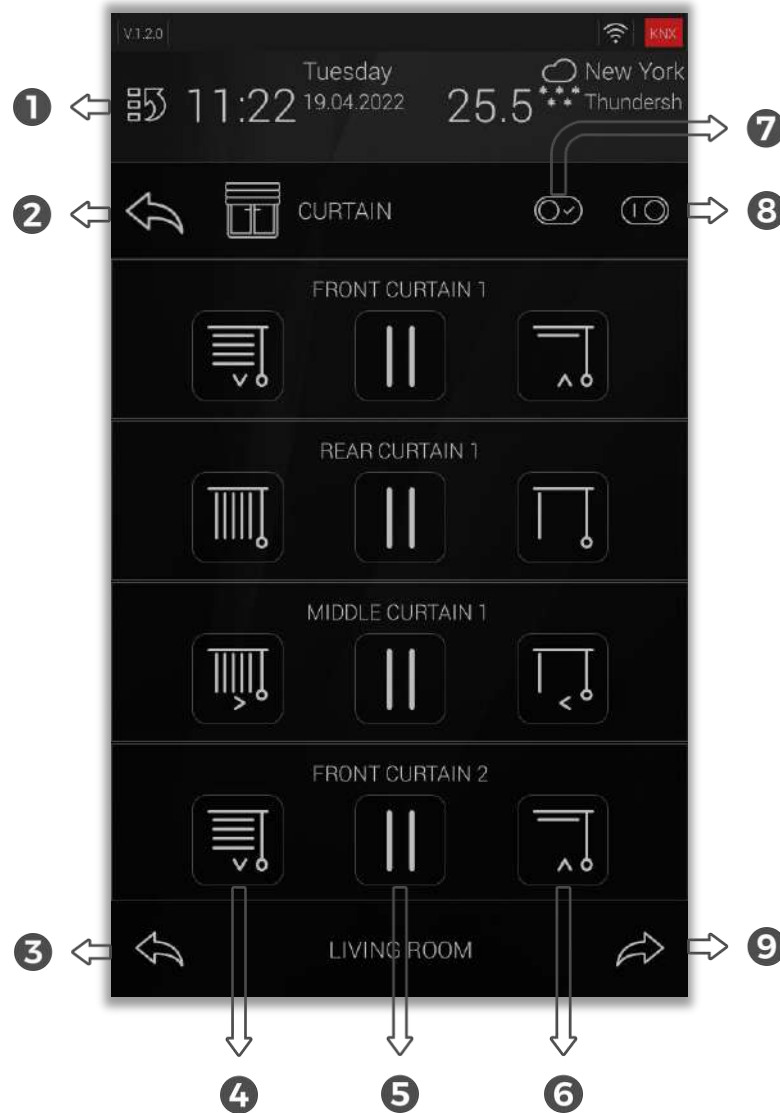

Fig. 11 : Curtain Section

Touch buttons that can be used in the blind section are described below:

- 1 This touch button is used to return to the home page. It is used for the same purpose in different sub-menus.
- 2 This touch button is used to return to the previous parent page.

- 3** This touch button is used to move to the back location.
- 4** The curtain can be moved downwards by pressing this touch button.
- 5** The curtain in motion can be stopped by pressing this touch button.
- 6** The curtain can be moved upwards by pressing this touch button.
- 7** This touch button is used to close all the curtains in the relevant area.
- 8** This touch button is used to open all the curtains in the relevant area.
- 9** This touch button is used to move to the next location.

6. Blind

Blinds defined in the relevant area can be controlled individually or all at once from this blind section.

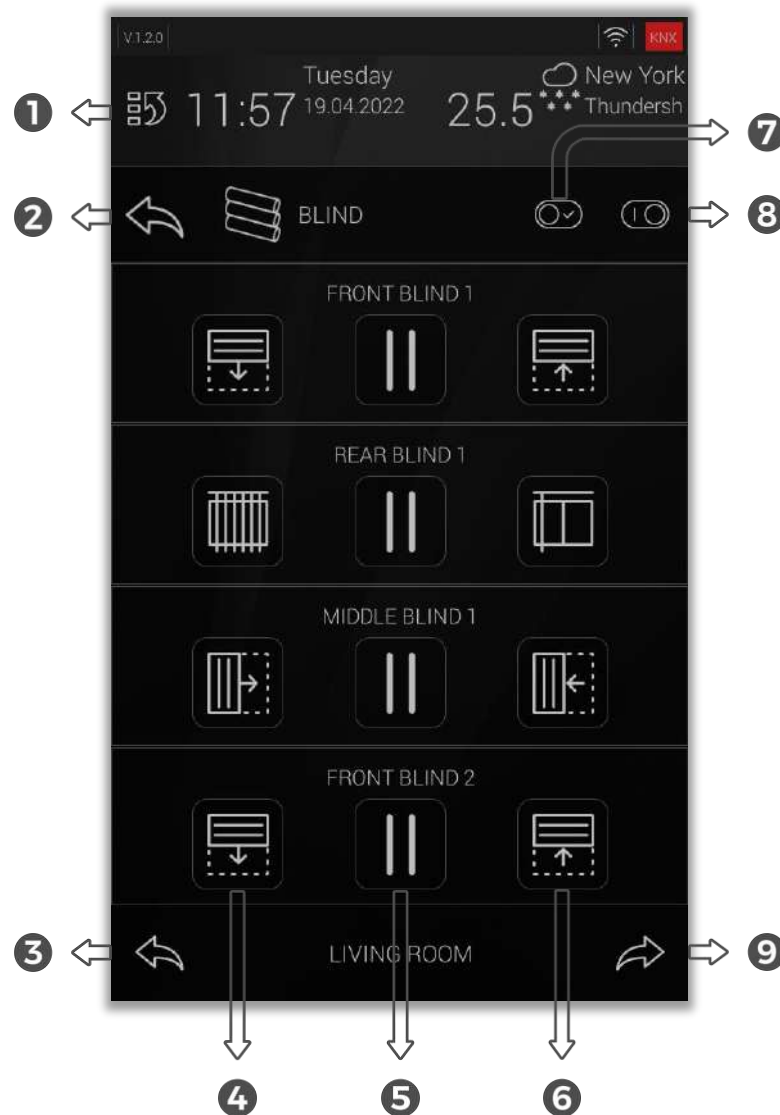

Fig. 12 : Blind Section

Touch buttons that can be used in the blind section are described below:

- 1 This touch button is used to return to the home page. It is used for the same purpose in different sub-menus.
- 2 This touch button is used to return to the previous parent page.
- 3 This touch button is used to move to the back location.

- 4** The blind can be moved downwards by pressing this touch button.
- 5** The blind in motion can be stopped by pressing this touch button.
- 6** The blind can be moved upwards by pressing this touch button.
- 7** This touch button is used to close all the blinds in the relevant area
- 8** This touch button is used to open all the blinds in the relevant area.
- 9** This touch button is used to move to the next location.

7. Air Condition

Air defined in the relevant area can be controlled individually or all at once from this air section.



Fig. 13 : Air Conditioner Section

- 1 This touch button is used to return to the home page.
- 2 This touch button is used to return to the previous parent page.
- 3 Air Conditioners in the room are listed next to the Air Conditioner symbol. The Air Conditioner to be adjusted is selected.
- 4 This part is the power menu of the Air. Air is opened and closed with On - Off touch buttons
- 5 The Air Conditioner temperature is set. Temperature adjustment is made by pressing the - and + touch buttons. The set temperature is displayed between - and + touch buttons.

- 6** Fan speed level modes are selected. There are four fan speed modes. These modes are Auto, Low, Mid and High.

- 7** It is a shortcut to Heating or Cooling. By pressing the heating or cooling touch button, an Air temperature adjustment is made. The temperature value set with these shortcuts is the value saved in the system

- 8** This touch button is used to move to the back location.

- 9** This touch button is used to move to the next location.

8. General

All on/off controls within the project shall be performed on this page except lightning, curtain, shutter, and air-conditioner controls. Control shall be opened when desired icons are clicked. If clicked while the icon is in orange colour, it shall be turned off.



Fig. 14 : General Section

- 1** This touch button is used to return to the home page.
- 2** This touch button is used to return to the previous parent page.
- 3** This touch button is used to move to the back location.
- 4** This touch button is used to turn on devices at the relevant area.
- 5** This touch button is used to turn off all devices at the relevant location.
- 6** This touch button is used to move to the next location.

9. Schedule

A schedule is a list of planned activities or things to be done showing the times or dates when they are intended to happen or be done. The schedule defined in the relevant area can be controlled individually or all at once from this schedule section.



Fig. 15 : Schedule Section

- 1 This touch button is used to return to the home page.
- 2 This touch button is used to return to the previous parent page.
- 3 This touch button is pressed to execute the selected schedule.

- 4 This touch button is pressed to activate/deactivate the planned activity.



Active



Deactivate

Fig. 16 : Schedule Activity Status

- 5 This touch button is pressed to show when the planned activity is scheduled.

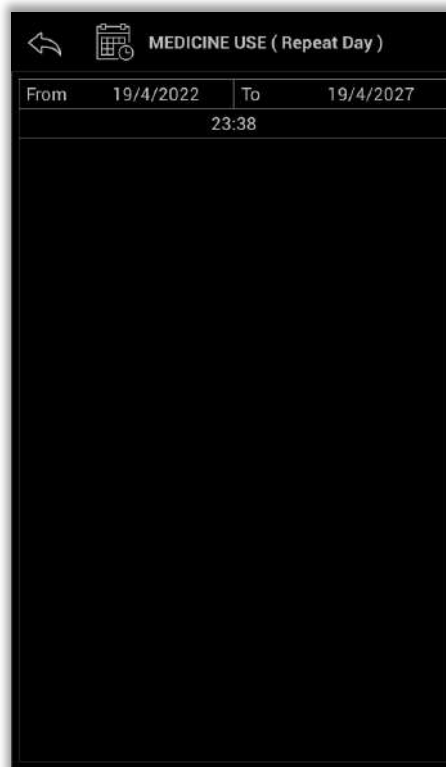

Fig. 17 : Schedule Activity Information

- 6 Go to Create Schedule section to create a copy of the selected schedule
- 7 This touch button is pressed to delete the planned activity.
- 8 This touch button is pressed to create the planned activity.

9.1. Create Schedule

The schedule can be created from the Lighting, General or Schedule sections. The Create Schedule section consists of 3 stages. These stages are Define Schedule, Add Schedule Process and Add Schedule Time.

9.1.1. Define Schedule

The first step in creating a plan is naming the Schedule. Plans created from sections other than the Schedule section come with the name of the section and room where they were created. This name can be changed.

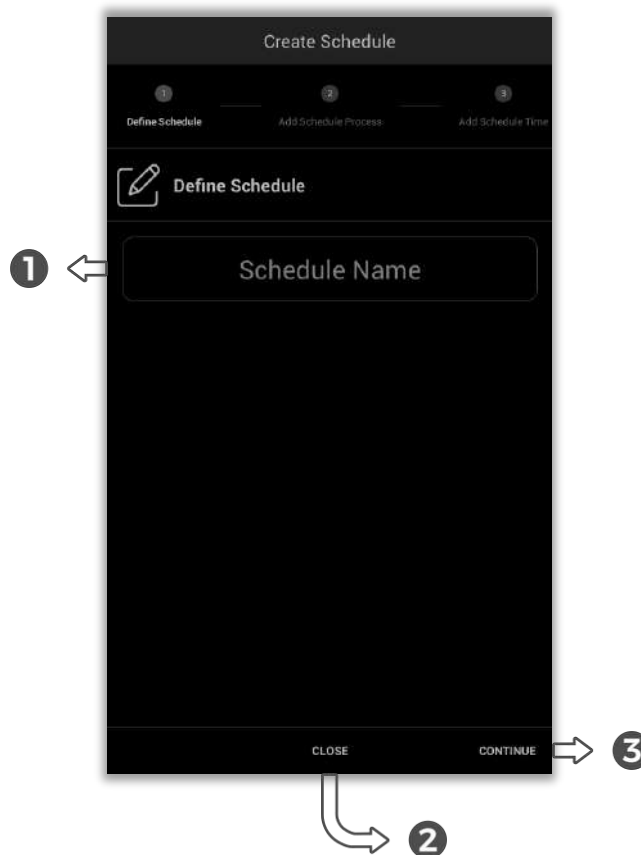

Fig. 18 : Create Schedule - Define Schedule

- 1 The schedule name is written in this text box.
- 2 This touch button is pressed to exit Create Schedule.
- 3 This touch button is pressed to continue to Add Schedule Process. If the plan name is not given, an error will appear on the screen, which will not proceed to the next step.

9.1.2. Add Schedule Process

After the name of the activity to be planned is determined, the "Add Schedule Process" step is started. At this step, the actions to be taken in the activity to be planned are added.

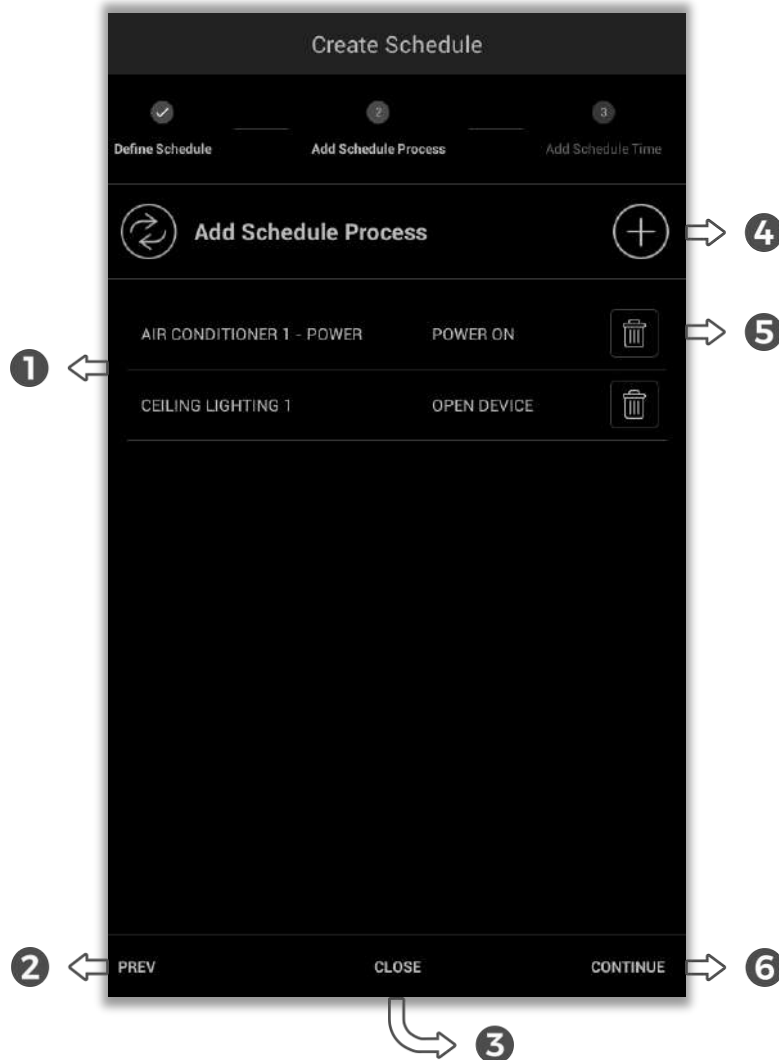

Fig. 19 : Create Schedule - Add Schedule Process

- 1 This part is the list of activities in the plan to be created.
- 2 This touch button is pressed to back the previous part.
- 3 This touch button is pressed to close Create Schedule.
- 4 This touch button is pressed to Add Activity. ([Sec. 9.1.2.1.](#))
- 5 By pressing this touch button, the selected activity is deleted.
- 6 After the Add Schedule Process step is completed, this touch button moves to the Add Schedule Time step. ([Sec. 9.1.3.](#))

9.1.2.1. Add Activity

A new activity is added to the Add Schedule Process from this section.

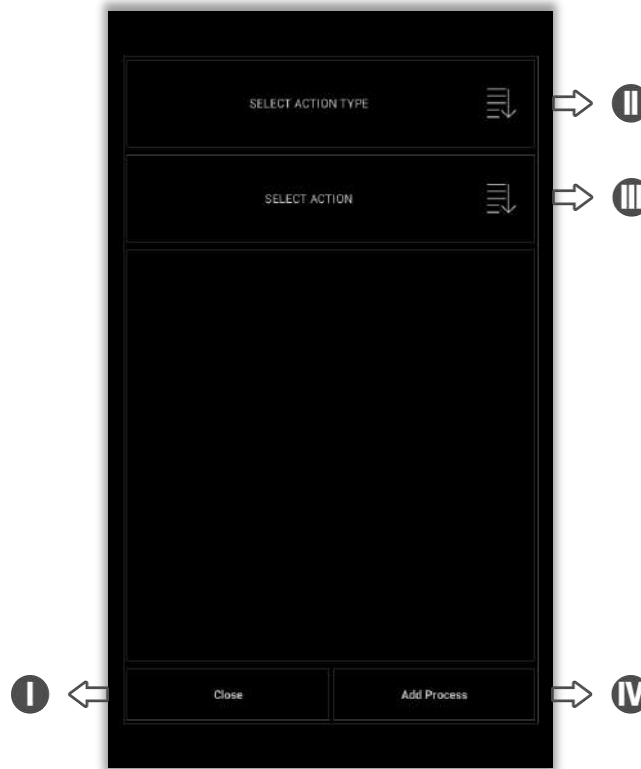

Fig. 20 : Add Schedule Process Step Window

- I This touch button is pressed to close this window.
- II The touch button is pressed to complete adding activity.

III This touch button is pressed to make an Action type selection.

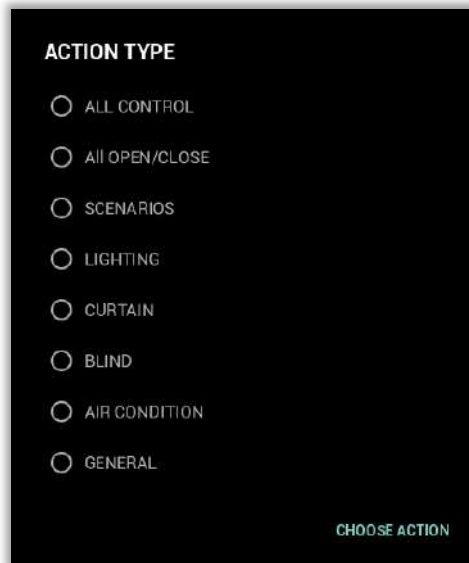

Fig. 21 : Create Schedule – Add Schedule Process Step 2

IV This touch button is pressed to make an Action selection.

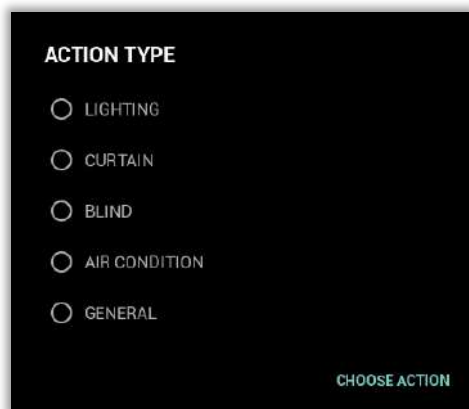

Fig. 22 : Create Schedule – Add Schedule Process Step 3

After the action is selected, the action to be performed by the action is selected.

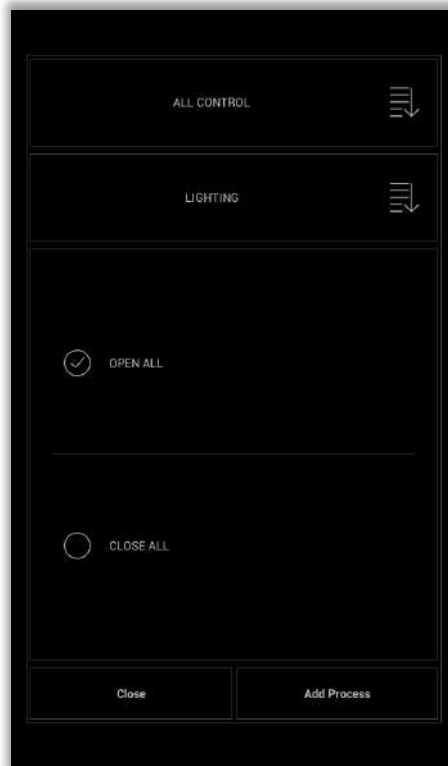

Fig. 23 : Create Schedule – Add Schedule Process Step 4

After the Activity Adding Process is finished, the “Add Process” button is pressed. If another activity is to be added to the created plan, it can be added by performing the same operations.

9.1.3. Add Schedule Time

The time of the Schedule created in the third step is determined in this part.

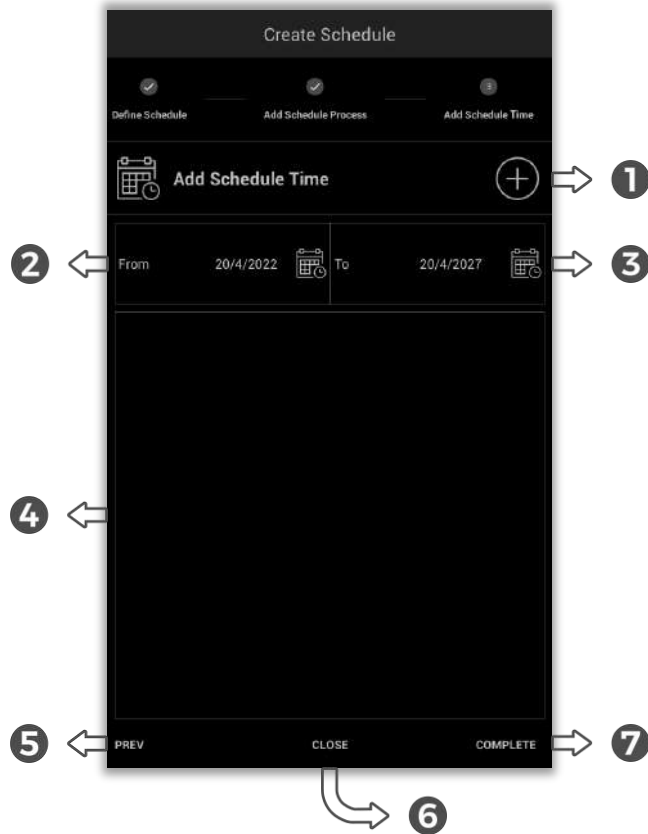

Fig. 24 : Create Schedule - Add Schedule Time

- 1 This touch button is pressed to set the frequency of the schedule. Selection is made from the list in Figure 25.

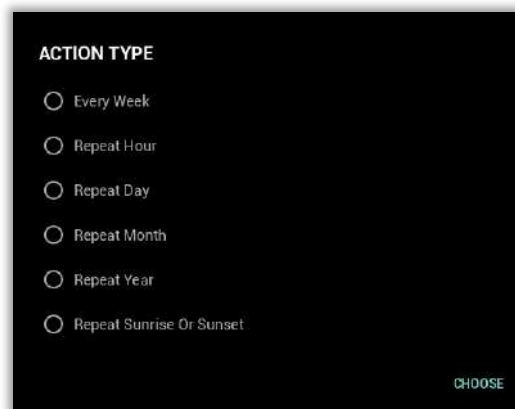

Fig. 25 : Create Schedule - Add Schedule Time Action Type Selection

- 2 By pressing this touch button, the Calendar's start date is set.
- 3 By pressing this touch button, the end date of the calendar is set.

Note: You can refer to [Section 18.2.1.4](#). to set the date

- 4 Time selection is made here according to the frequency of the selected Schedule. The views according to the selected mode are in the images below.

Every Week

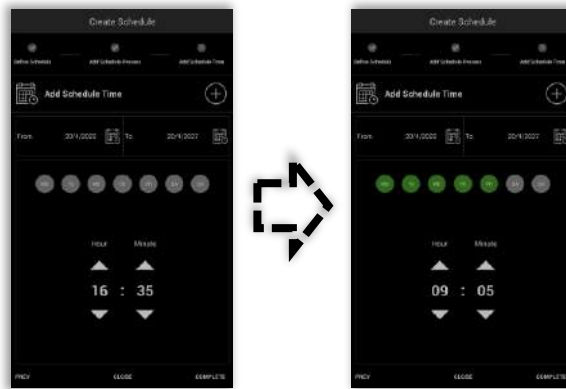

Fig. 26 : Create Schedule - Add Schedule Time Set

Repeat Hour

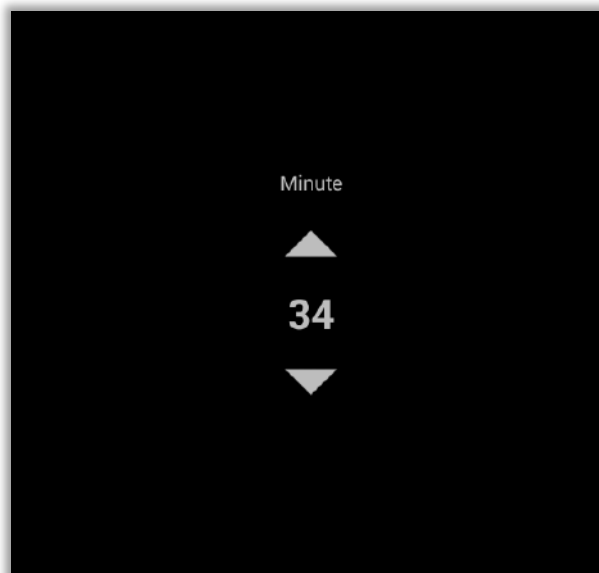

Fig. 27 : Create Schedule - Repeat Hour

Repeat Day

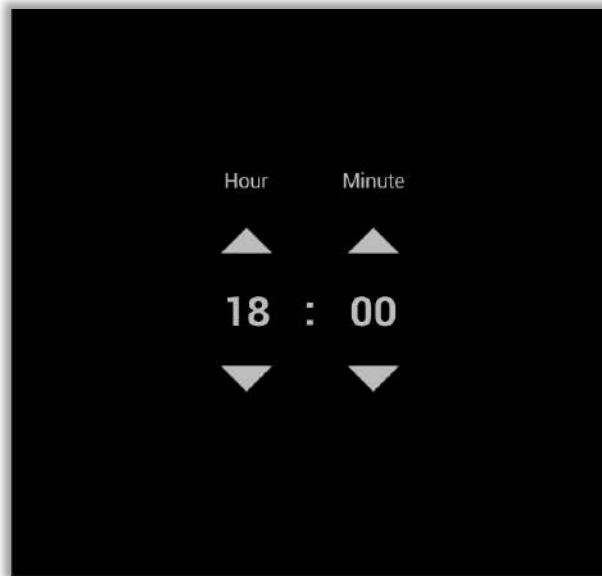

Fig. 28 : Create Schedule - Repeat Day

Repeat Month

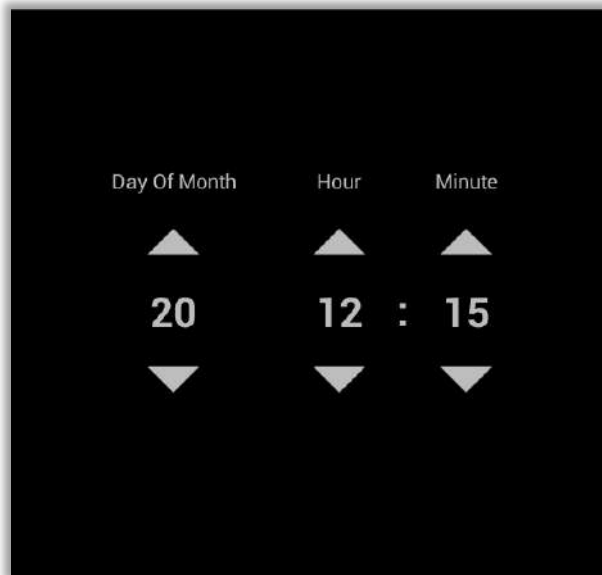

Fig. 29 : Create Schedule - Repeat Month

Repeat Year

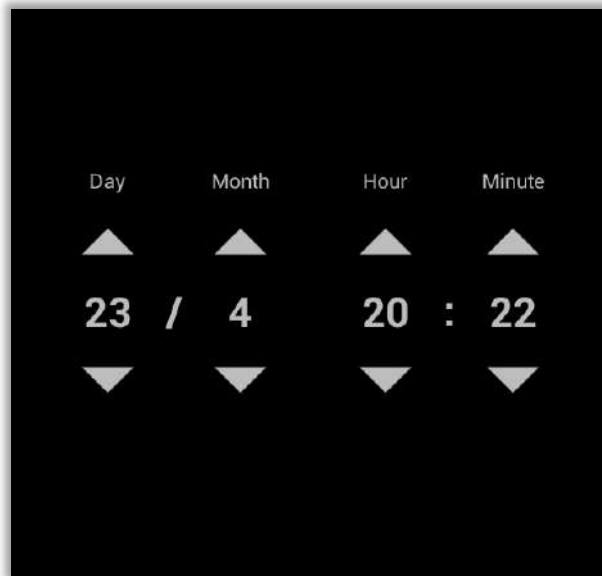

Fig. 30 : Create Schedule - Repeat Year

Repeat Sunrise or Sunset

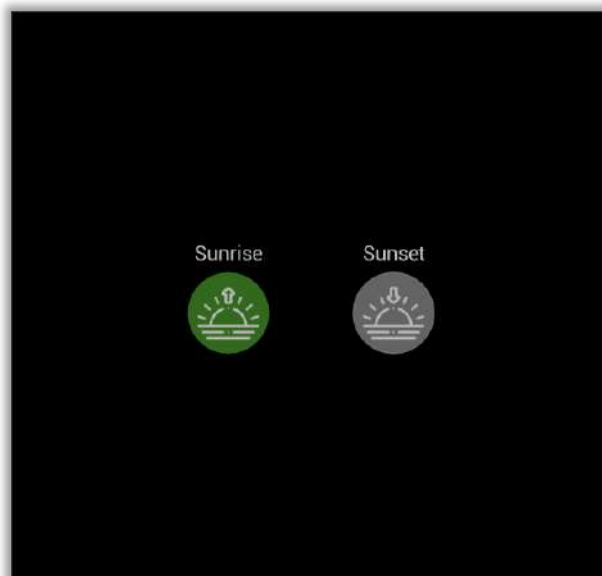

Fig. 31 : Create Schedule - Repeat Sunrise or Sunset

- 5 This touch button is pressed to back the previous part.
- 6 This touch button is pressed to close Create Schedule part.
- 7 This touch button is pressed to complete Add Schedule Time part.

10. Scenario

The scenarios within the system or the scenarios registered by the user shall be activated over this screen. For Example, since Leaving Home scenario contains the deactivation of power sockets and lighting. This process can be activated with just one button. On the contrary, for the Getting Home scenario, all lighting, curtain, shutter and power sockets shall be activated with just one button. Multiple scenarios can be defined on the touch panel. Defined scenarios can be deleted, copied, or rearranged or a new scenario can be created. A summary of scenarios can be displayed on the scenario details screen that displays the location settings of each control.

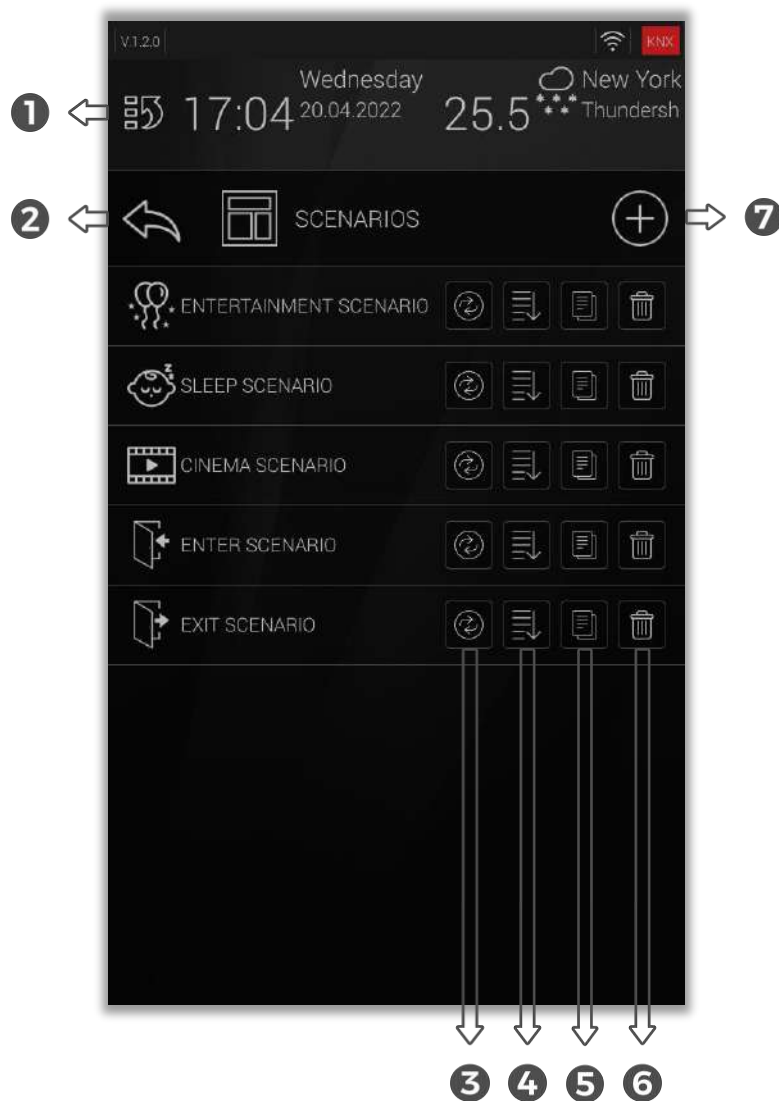

Fig. 32 : Scenario Section

- 1 This touch button is used to return to the home page.
- 2 This touch button is used to return to the previous parent page.

- 3 This touch button is pressed to execute the selected scenario.
- 4 This touch button shows the running devices and their tasks in the Scenario.
- 5 Go to Create Scenario section to create a copy of the selected scenario.
- 6 This touch button is pressed to delete the planned scenario.
- 7 This touch button is pressed to create the planned activity ([Sec. 10.1.](#)).

10.1. Create Scenario

There are 2 steps to creating a scenario, the first this step is Define Scenario and the second step is to Add Scenario Process.

10.1.1. Define Scenario

The first step in creating a scenario is naming the Scenario.



Fig. 33 : Create Scenario - Define Scenario

- 1 The scenario name is written in this text box.
- 2 This touch button is pressed to exit Create Scenario.

- 3 This touch button is pressed to continue to Add Scenario Process. If the plan name is not given, an error will appear on the screen, which will not proceed to the next step.

10.1.2. Add Scenario Process

At this step, the actions to be taken in the activity to be planned are added.

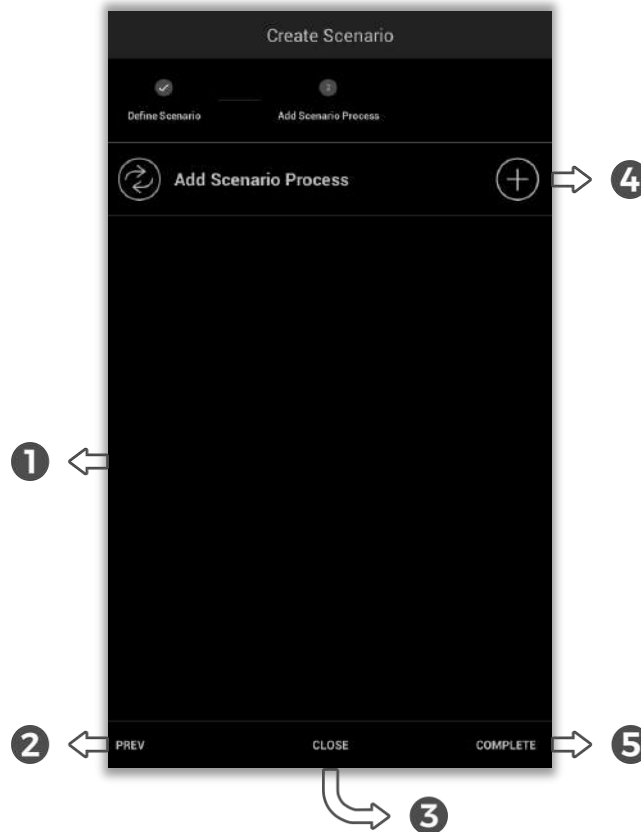

Fig. 34 : Create Scenario - Add Scenario Process

- 1 This part is the list of activities in the plan to be created.
- 2 This touch button is pressed to back the previous part.
- 3 This touch button is pressed to close Create Scenario.
- 4 This touch button is pressed to Add Activity. ([Sec. 10.1.2.1.](#))
- 5 By pressing this touch button, the Add Scenario Process phase is completed.

10.1.2.1. Add Activity

A new activity is added to the Add Schedule Process from this section.

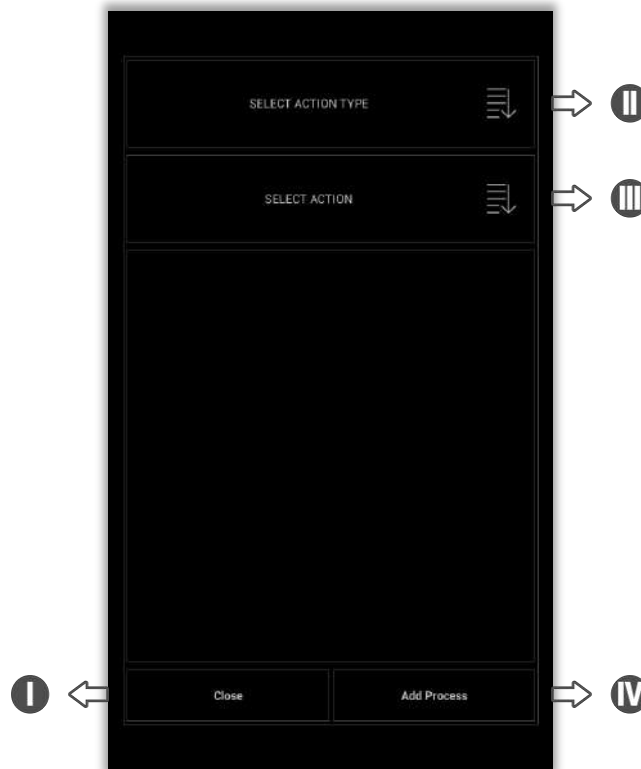

Fig. 35 : Add Scenario Process Step Window

- I** This touch button is pressed to close this window.

- II** This touch button is pressed to make an Action type selection.

III This touch button is pressed to make an Action selection.

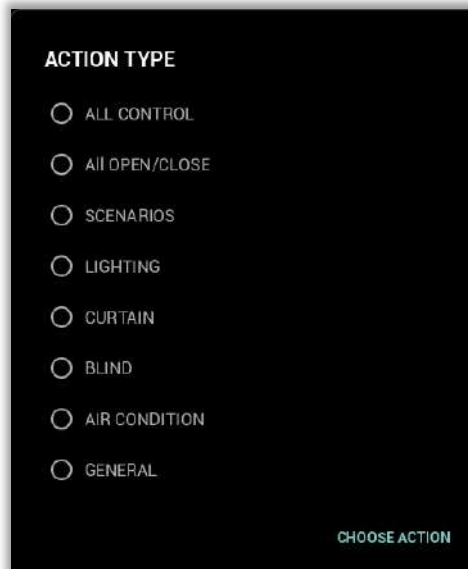

Fig. 36 : Create Scenario – Add Scenario Process Step 2

IV The touch button is pressed to complete adding activity.

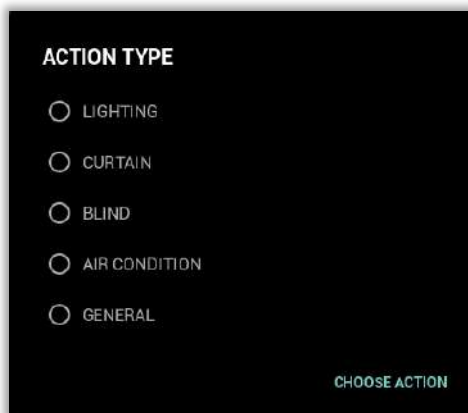

Fig. 37 : Create Scenario – Add Scenario Process Step 3

After the action is selected, the action to be performed by the action is selected.

11. Services

You can find services, which are planned to be sent over integrated concierge servers, from here. By touching on the desired service, a request is sent to the server by reporting necessary details. The Services menu includes default sub-menus such as Spa, Taxi, Maintenance, Shuttle, Cleaning, Bellboy, Car Wash etc. You need to define the time, date and count of service. Sending notes while sending the request is available as well. After necessary blanks (time, date, note etc.) are filled, the service request gets ready to send. Your requests which are prepared with a selection of those menus shall be submitted to Management or relevant channels. Unnecessary services can be closed via Panel Configurator. You should contact the company if you request new services.

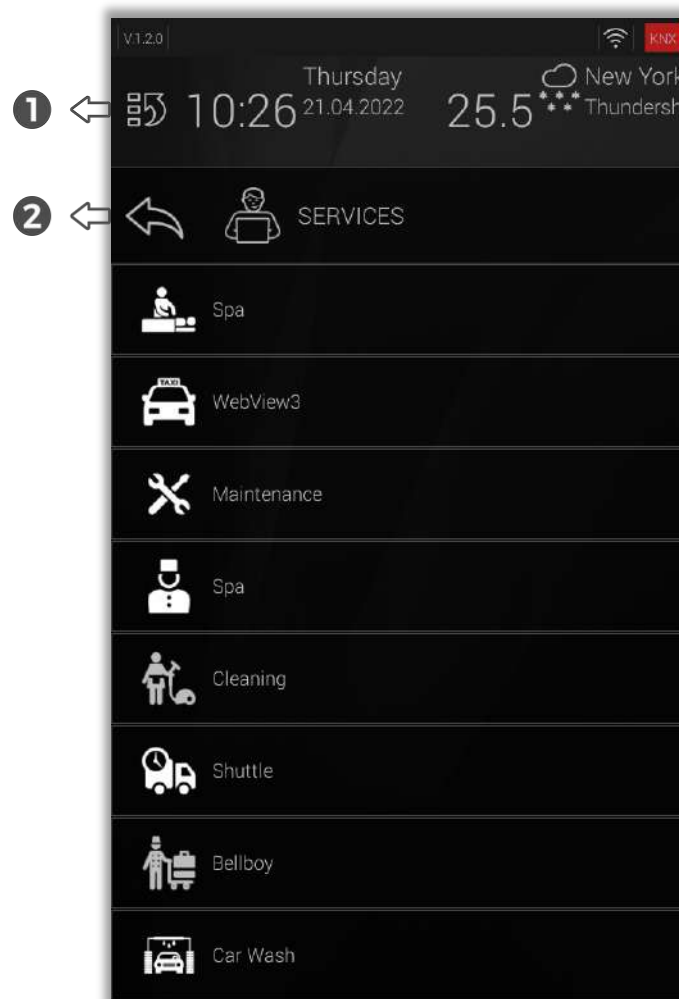

Fig. 38 : Services Section

- 1 This touch button is used to return to the home page.
- 2 This touch button is used to return to the previous parent page.

12. Alarm

According to the data received from all alarm detectors within the system, a security system could be established. After selecting the predefined alarm, you should enter the alarm password to activate or deactivate the alarm. Setting up a new alarm or deleting the desired one's operations can be performed over Panel Configurator.

You can review all defined alarm objects on the list of alarm screens. Alarms can be activated or deactivated by entering an alarm password. To be able to set up a new alarm from Panel Configurator, alarm objects which have been defined on Panel Configurator by you, should not be in the detection state. If you attempt to set up an alarm in a detection state, you will get a warning. You can see whether an alarm is active or not on the alarm page. At the same time, you can see each detector, whether in a detection state or not, from the same screen. If you wish, you can make those alarms inactive and prevent alarms from being setup.

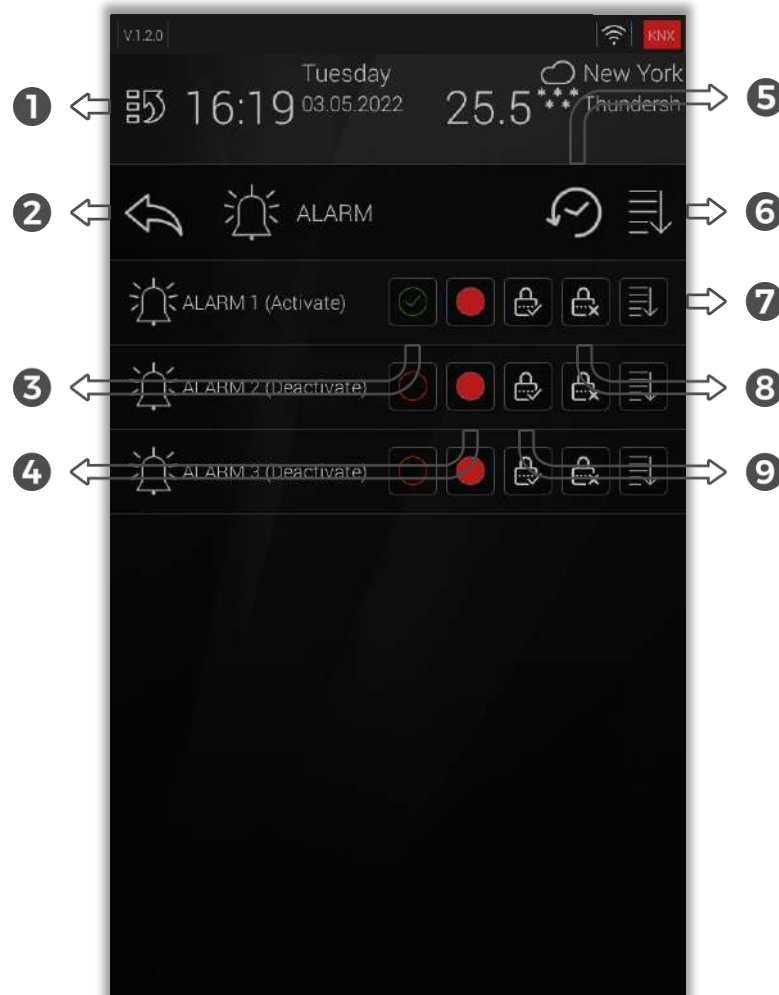

Fig. 39 : Alarm Section

- 1 This touch button is used to return to the home page.

2 This touch button is used to return to the previous parent page.

3 This touch button is pressed to activate/deactivate the alarm.



Fig. 40 : Schedule Activity Status

4 Shows the status of alarm detectors.

5 This touch button is used to show Alarm Action History.



Fig. 41 : Alarm Action History Window

1 This touch button is pressed to close this window.

2 The touch button is pressed to delete Alarm Action History.

6 Alarm detectors defined by this touch button are listed. Detectors from this list can be turned on or off.

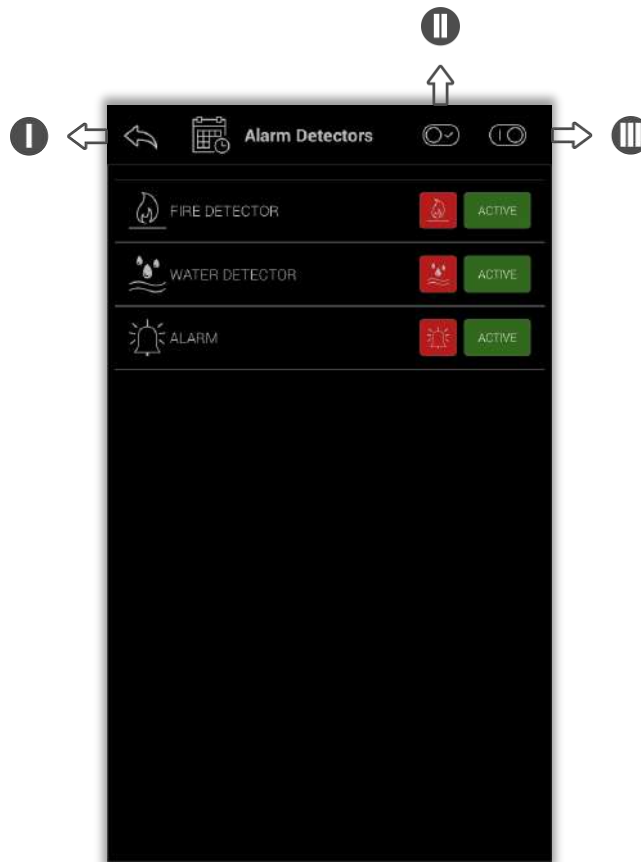

Fig. 42 : Alarm Detectors Window

- I** This touch button is pressed to close this window.
- II** This touch button is used to open all the alarm detectors in the relevant area.
- III** This touch button is used to close all the alarm detectors in the relevant area.

7 Lists detectors found in the selected alarm scenario.

8 This touch button is used to turn off the selected alarm scenario. When the touch button is pressed, the alarm is turned off by entering the password.

9 This touch button is used to turn on the selected alarm scenario. When the touch button is pressed, the alarm is turned on by entering the password.

13. Contact

You can reach the registered contacts in the directory from this section. Missed calls can be viewed from here. It is possible to make calls from here via all registered Phone IPs. Just touch oncall button to to communicate with the people registered into the system.



Fig. 43 : Contact Section

- 1 This touch button is used to return to the home page.
- 2 This touch button is used to return to the previous parent page.
- 3 The missed calls list is displayed.

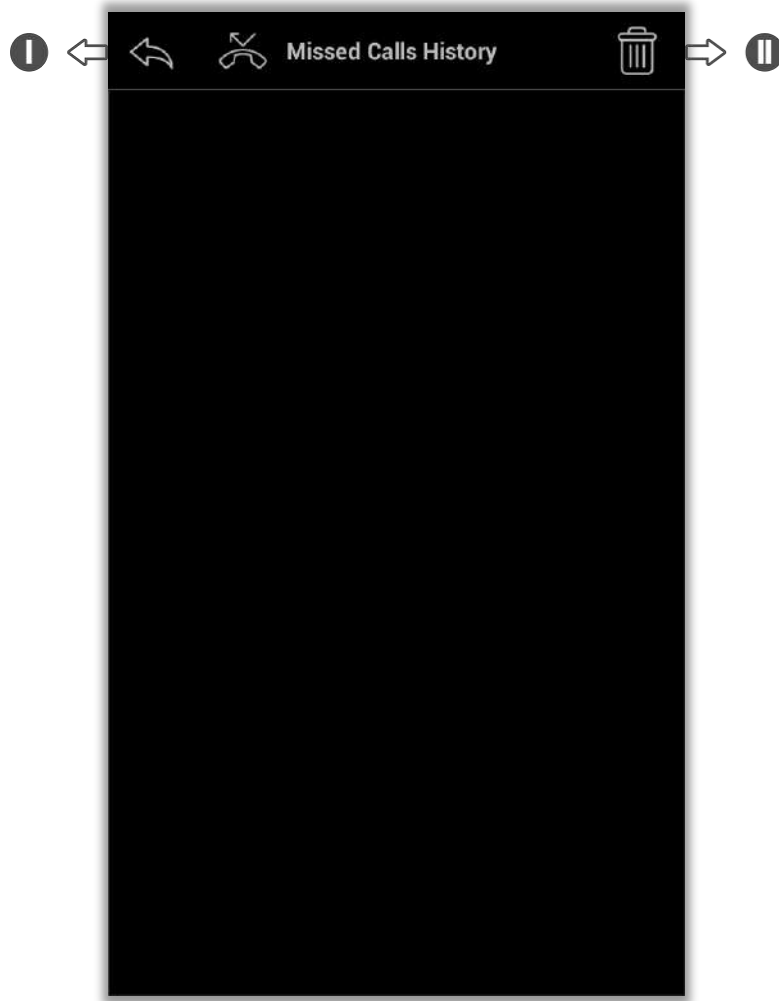

Fig. 44 : Missed Calls History Window

- I This touch button is pressed to return to the Contact section.
 - II The touch button is pressed to delete missed calls.
- 4 Pressing this touch button opens the Dialer. By entering the number, a call is made to a household/device registered in the system.

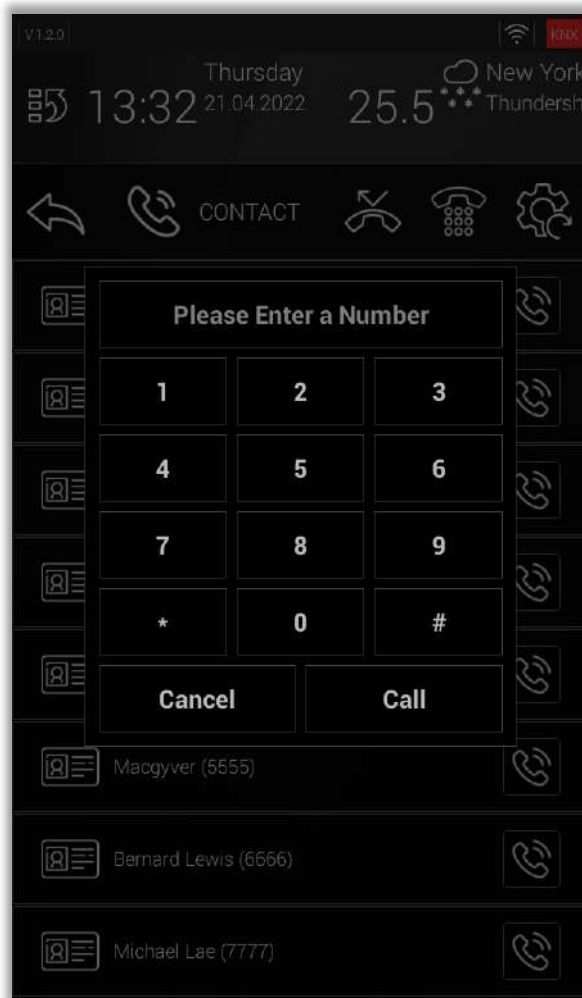

Fig. 45 : Dialer Window

5 By pressing this touch button Contact will be reset to factory settings.

6 By pressing this touch button, the selected contact is called.

- Supported protocols are RTSP(Real-Time Streaming Protocol), and M JPEG(Motion JPEG).
- There is no camera on the panel due to security reasons. The Interra Touch Panel can only transmit the image taken from the outside cameras.

14. Cams

DVR, NVR and IP cameras, which are integrated into the system and makes broadcasting over protocols(*) supported by Interra Touch Panels, provides simultaneously monitoring opportunity from here

(*) Supported protocols are RTSP(Real-Time Streaming Protocol) and MJPEG(Motion-JPEG).

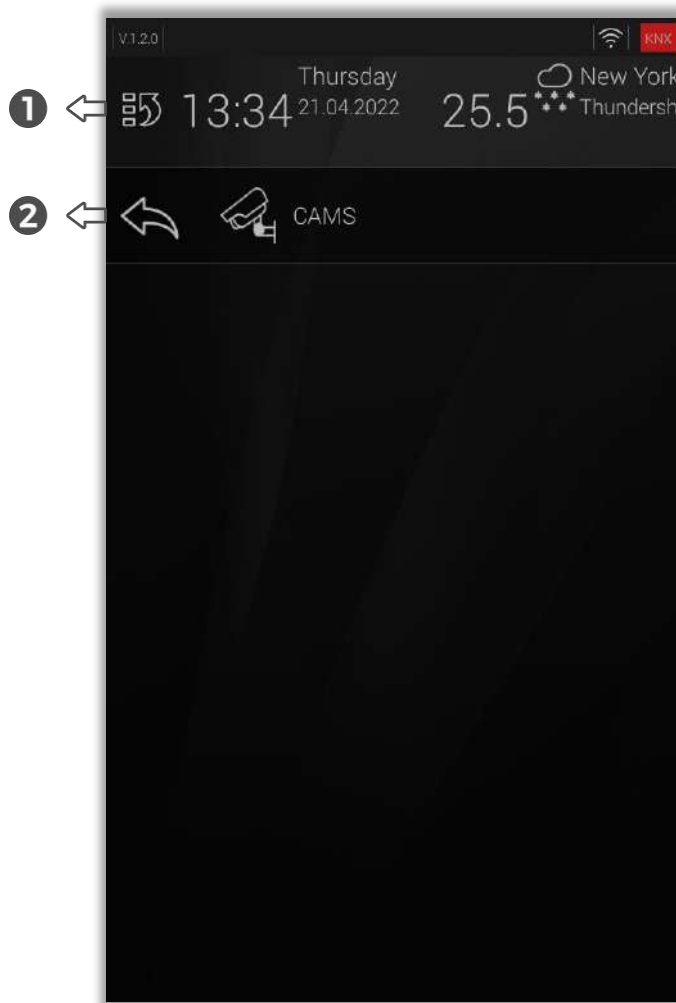

Fig. 46 : Cams

- 1 This touch button is used to return to the home page.
- 2 This touch button is used to return to the previous parent page.

15. Site Management

Announcements, Invoices, and Information messages, which are sent via the site management interface over the integrated concierge server, shall be displayed. If data is received as a message by the device, the number of indicators increases. The content of a message can be opened by clicking on the message. This menu has 3 submenus as Announcements, Invoices and Information. Additional submenus can be added via Panel Configurator.

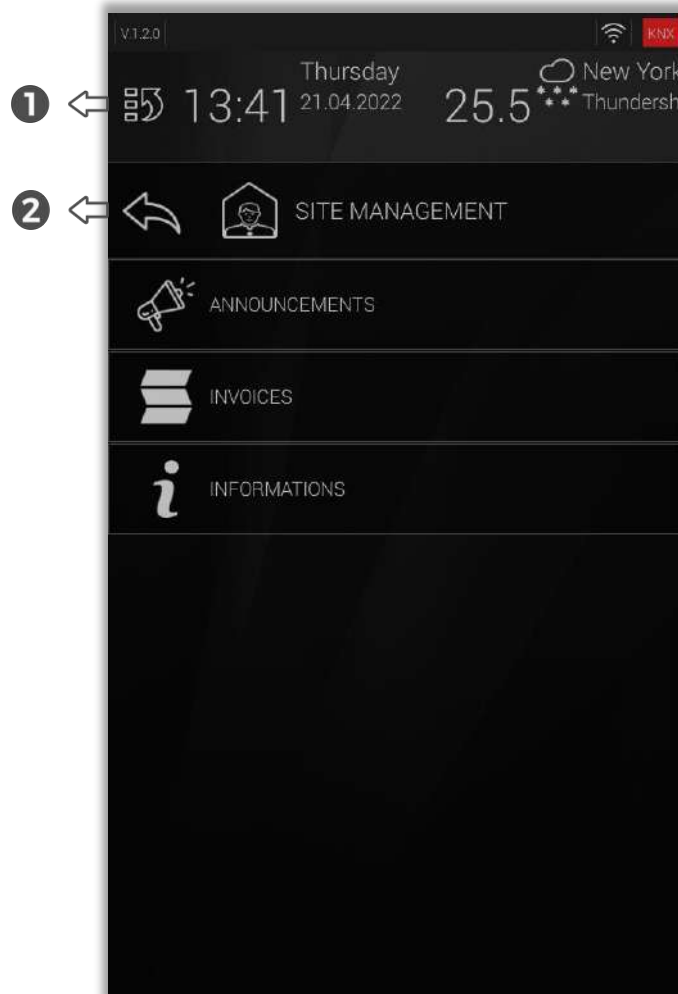

Fig. 47 : Site Management

- 1 This touch button is used to return to the home page.
- 2 This touch button is used to return to the previous parent page.

16. Messages

Messages sent via the site management interface on the integrated concierge server shall be displayed on this menu. They could be followed over Warnings indicators and buttons located in the upper-right corner. If data is received as a message by the device, the number of indicators increases. The content of the message can be opened by clicking on the message.

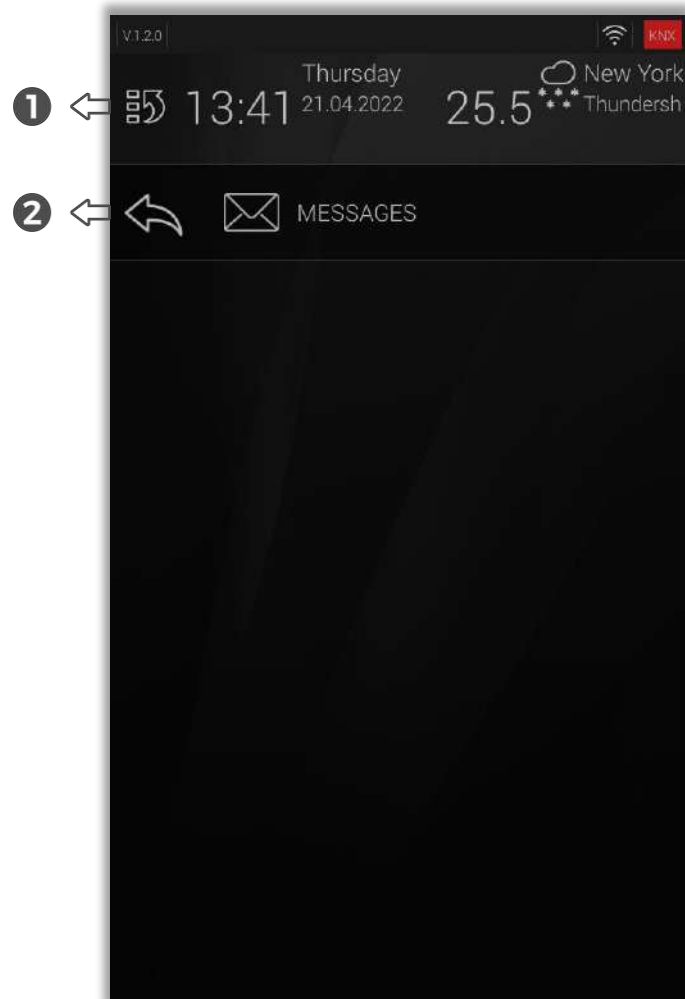

Fig. 48 : Messages

- Unread messages in red background.
- Read messages shall be automatically dropped from Warnings sections

1 This touch button is used to return to the home page.

2 This touch button is used to return to the previous parent page.

17. Settings Menu

Dashboard	⇒	17.1 Go to dashboard (Main Screen)
Settings	⇒	17.2 Settings include General, Info, Network, Alarm Passwords and Door Bell sections. Touch Panel is set via Settings
Theme	⇒	17.3 Set to theme of the Touch Panel
Connections	⇒	17.4 Creating or removing mobile users, information about users and create the QR code for users
About	⇒	17.5 Information about Touch Panel
Help	⇒	17.6 Go to User Manual
Diagnostic	⇒	17.7 Go to Diagnostic
Close	⇒	17.8 Close to System
Reboot	⇒	17.9 Reboot to System

Fig. 49 : Settings Menu

In this section, configurations can be made for the touch panel. This menu includes going to the dashboard (main screen), settings (changing the language for the user interface, determining the doorbell and screen saver type, etc.), changing the theme, creating a mobile user, the about section, the help section to get help about the device, the diagnostic, the device close and reboot sections. includes. For any user changes, it is possible to log in with the administrator password.

17.1. Dashboard

For information, go to [Section 3. Main Screen](#).

17.2. Settings

Settings include General, Info, Network, Alarm Passwords and Door Bell sections. Touch Panel settings are made with these sections.

17.2.1. General

In this section, general settings of the Touch Panel are made. The General section contains the general settings of the touch panel such as Language, Doorbell, SIP ring, Date info, Time info, Screen saver, Screen saver delay, Screen saver brightness, Screen saver password activation, Screen saver password, Admin password and Volume setting of the panel.

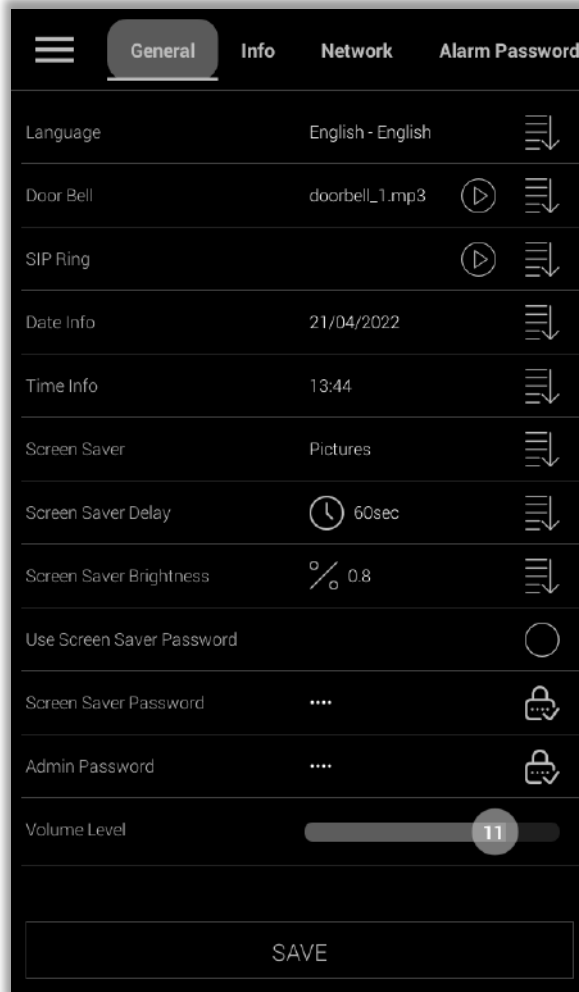

Fig. 50 : Settings General

17.2.1.1. Language

The panel can be set to 26 languages. The language of the panel is set here.

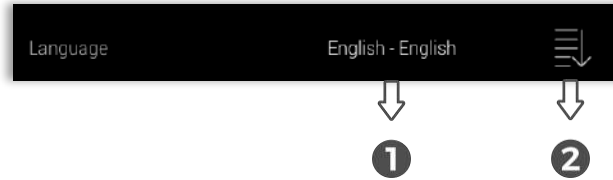

Fig. 51 : Language Bar

NUMBER	DESCRIPTION
1	Selected Language
2	Set Button

- 1 The Language setting in this section is displayed.
- 2 By pressing this touch button, set the Language of the panel. The list of languages opens on the screen ([Fig. 52](#)). The language to be set is selected in the list.



Fig. 52 : Language List

To exit the list that appears on the screen without making any selection, the close touch button can be pressed.

17.2.1.2. Door Bell

The doorbell is the sound coming from the panel when the panel is called from any indoor or outdoor unit. Each panel comes with the default doorbells included.

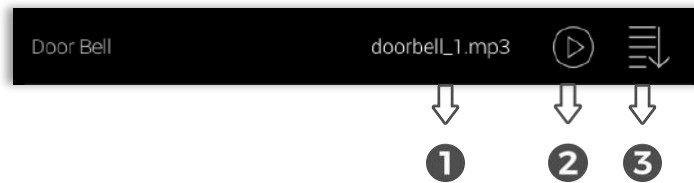

Fig. 53 : Door Bell Bar

NUMBER	DESCRIPTION
1	Door Bell Displayed
2	Plays the selected doorbell
3	Open the doorbell ringtones list

- 1 The Door Bell set in this section is displayed.
- 2 By pressing this touch button, the selected ringtone can listen to.
- 3 By pressing this touch button, set the ringtone of the panel.

A list of ringtones appears on the screen (Fig. 54). The desired ringtone can be selected from the ringtone list.

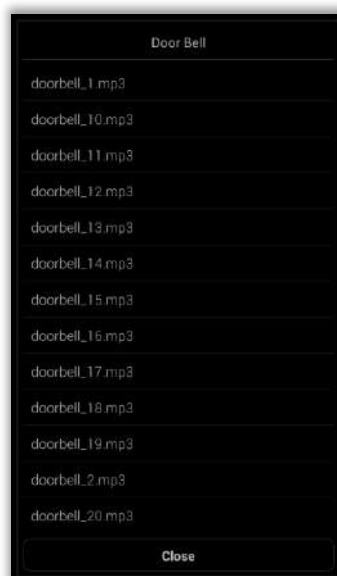

Fig. 54 : Door Bell Tones List

To exit the list that appears on the screen without making any selection, the close touch button can be pressed.

17.2.1.3. Sip Ring

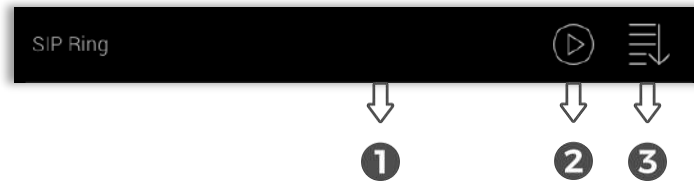

Fig. 55 : SIP Ring Bar

NUMBER	DESCRIPTION
1	The name of the selected doorbell is written
2	Plays the selected doorbell
3	Open the doorbell ringtones list

- 1 The Door Bell set in this section is displayed.
- 2 By pressing this touch button, the selected ringtone can listen to.
- 3 By pressing this touch button, set the ringtone of the panel.

A list of ringtones appears on the screen (Fig. 56). The desired ringtone can be selected from the ringtone list.

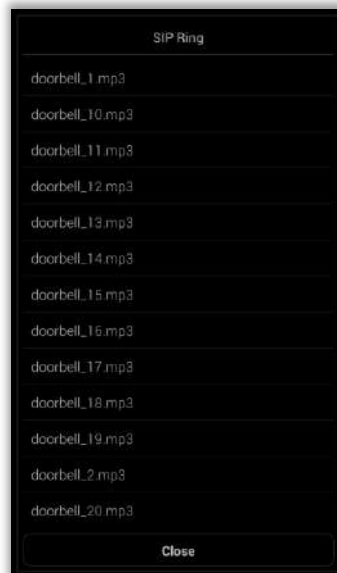

Fig. 56 : Sip Ring Tones List

To exit the list that appears on the screen without making any selection, the close touch button can be pressed.

17.2.1.4. Date Info

The date setting of the panel is made from this section. By default, the date is Day/Month/Year (DD/MM/YYYY).

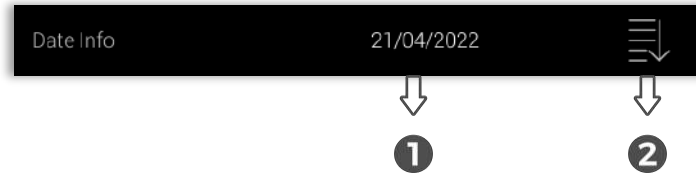

Fig. 57 : Date Info Bar

NUMBER	DESCRIPTION
1	Selected Date
2	Set Button

- 1 The Date Info set in this section is displayed.
- 2 By pressing this touch button, the Date Info is set. When the button is pressed, the calendar window appears on the screen ([Fig. 58](#)).

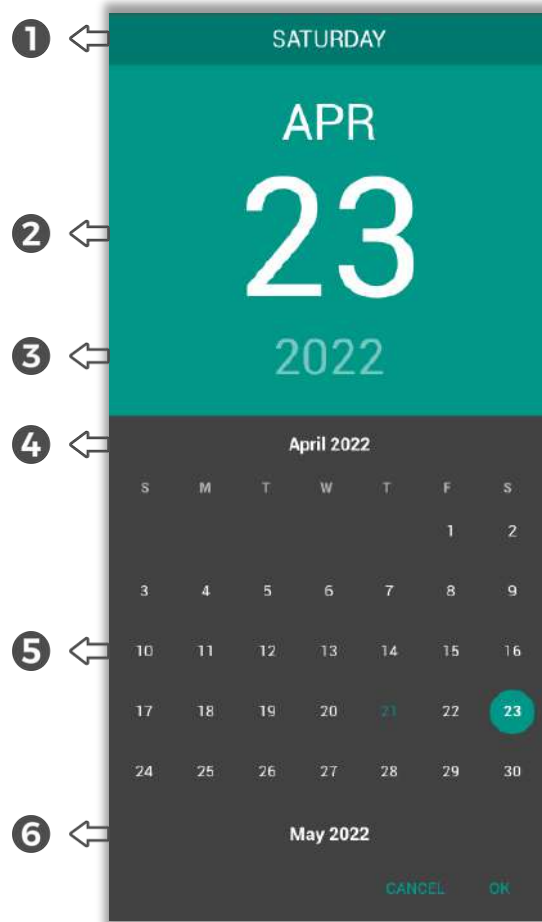

Fig. 58 : Calendar Window

NUMBER	DESCRIPTION
1	The name of the selected day
2	The name of the selected month.
3	Selected day
4	The selected year
5	The selected month and year
6	The Calendar
7	The name of the next month and year

- 1 The name of the Day set in this section is displayed.
- 2 Press this touch button for the Month and Day to be set. The name of the selected month and the selected day are displayed on this touch button.
- 3 Press this touch button for the year to be set. The year list appears in the grey part of the calendar (Fig. 59). The selected day is displayed on this touch button.

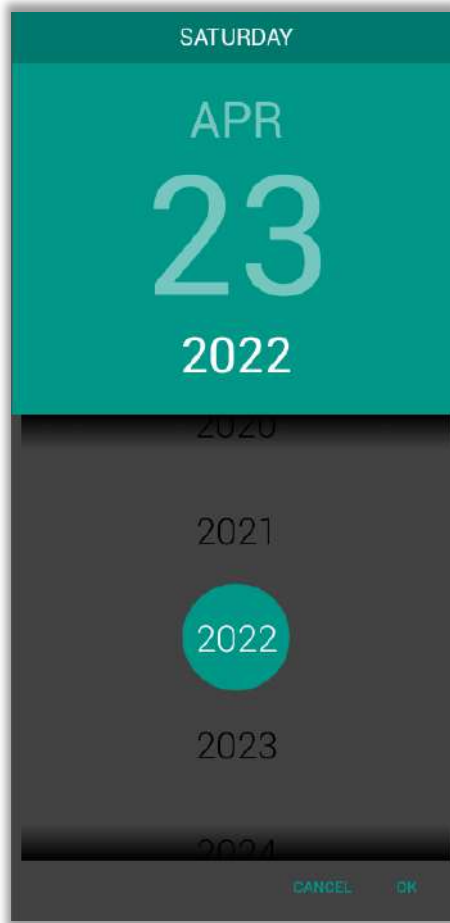

Fig. 59 : Calendar's Year Window

- 4 The Month and Year set in this section are displayed.
- 5 In this section, the day and month to be set are selected.

This part is in the form of a list. It can be scrolled up or down (Fig. 60). In this way, you can go to the previous or next month.



Fig. 60 : Calendar List

- 6 This touch button is a shortcut to go to the next month. The name of the next month is displayed on this touch button.

When the setting is complete, press OK to confirm or CANCEL to exit.

17.2.1.5. Time Info

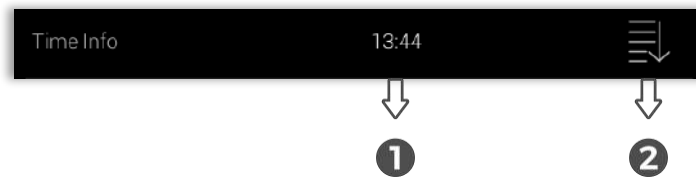

Fig. 61 : Time Info Bar

NUMBER	NAME
1	Selected Time
2	Set Button

- 1 The Time Info set in this section is displayed.
- 2 By pressing this touch button, the Time Info is set.

After pressing the button, the Time Window in Figure 62 appears on the screen. This window consists of two parts, an analogue clock on the left and a digital clock on the right. The set time is displayed in the digital clock section. An hour or minute setting selection is made from the digital clock. Click on it to set the hour (I) or minute (II). The time is set from the analogue clock part.

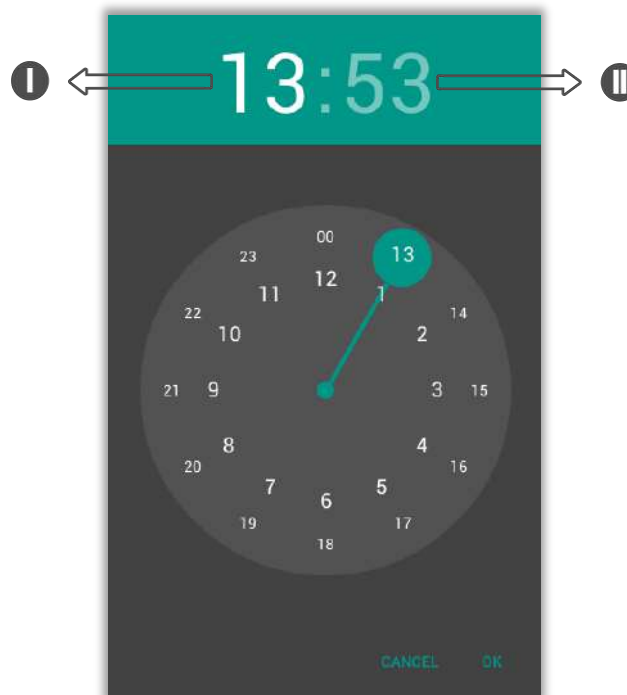

Fig. 62 : Time Window

NUMBER	NAME
I	Clock Part
II	Minute Part

- I The hour in the range of 00-24 to be adjusted is selected.



Fig. 63 : Clock Window

- II After setting the hour, the minutes are set. The minute is adjusted by dragging the green circle on the analogue clock in Figure 64.



Fig. 64 : Minute Window

After the process is finished, click OK to confirm. Press cancel to cancel.

17.2.1.6. Screen Saver

The screen saver section consists of two parts. these parts are shown in Figure 65 below.

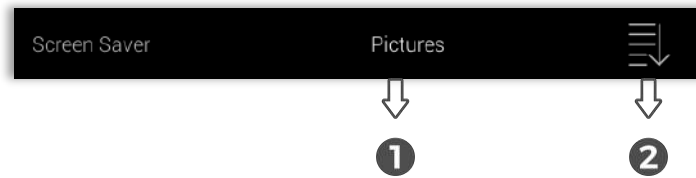

Fig. 65 : Screen Saver Bar

The names and numbers of the sections in the Screen Saver section are given below.

NUMBER	DESCRIPTION
1	Screen Saver Type Display
2	Set Button

- 1 The screen saver type set in this section is displayed.
- 2 By pressing this touch button, the screen saver type is set. After pressing the button, the screen saver type list in Figure 66 is displayed.

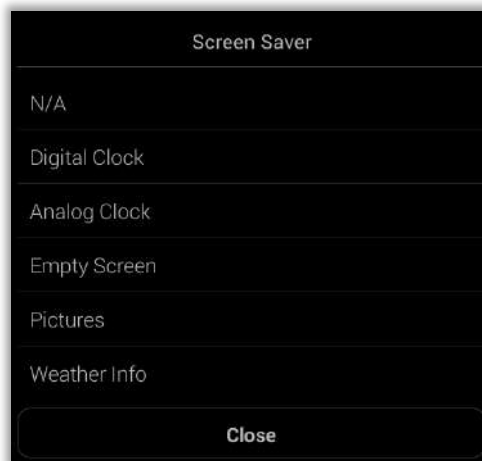

Fig. 66 : Screen Saver List

17.2.1.7. Screen Saver Delay

The screen saver delay is a time that enables the screen saver to be active after a certain time. This time can be set to 5-10-15-...-300 seconds.

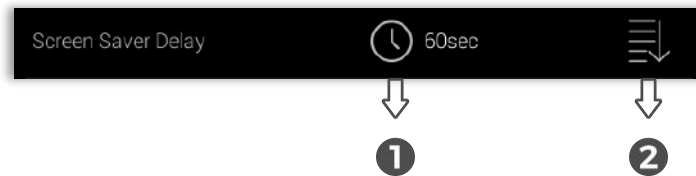

Fig. 67 : Screen Saver Delay Bar

The names and numbers of the sections in the Screen Saver Delay section are given below.

NUMBER	NAME
1	Screen Saver Delay Display
2	Set Button

- 1 The screen saver delay time set in this section is displayed.
- 2 By pressing this touch button, the screen saver delay time is set. After pressing the button, the screen saver delay time list in [Figure 68](#) is displayed.



Fig. 68 : Screen Saver Delay List

17.2.1.8. Screen Saver Brightness

It is the percentage of the screen saver's brightness when active. Screen saver brightness can be set to 10-20-...-90-100%.

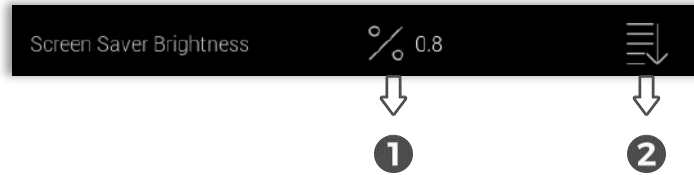

Fig. 69 : Screen Saver Brightness

The names and numbers of the sections in the Screen Saver Delay section are given below.

NUMBER	NAME
1	Screen Saver Brightness Display
2	Set Button

- 1 The Screen Saver Brightness per cent set in this section is displayed.
- 2 By pressing this touch button, the screen saver brightness per cent is set. After pressing the button, the screen saver brightness per cent list in Figure 70 is displayed.

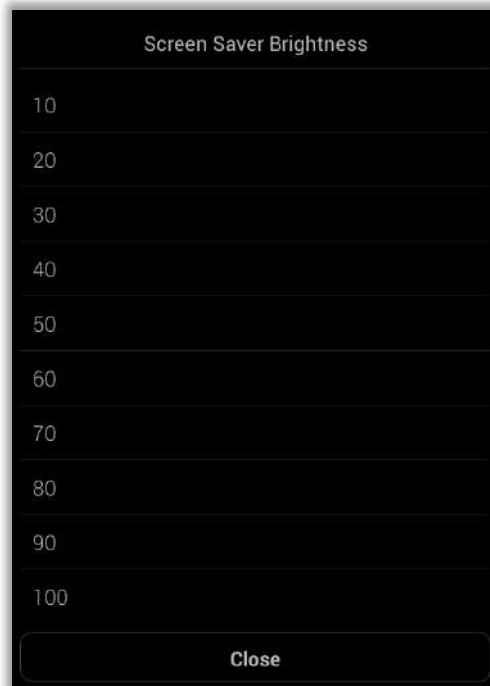

Fig. 70 : Screen Saver Brightness List

17.2.1.9. Use Screen Saver Password

Screen Saver has a lock system. When Screen Saver Password is enabled, it asks for a password to exit the Screen Saver. The screen saver password is enabled/disabled here.

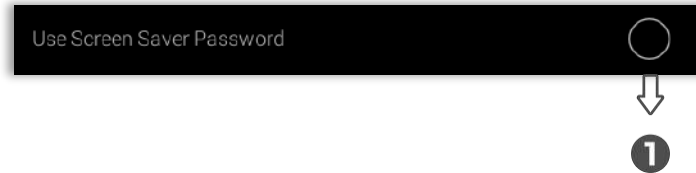

Fig. 71 : Use Screen Saver Password Bar

- 1 The screen saver is enabled or disabled by pressing the touch button.



Fig. 72 : Use Screen Saver Password Touch Button

17.2.1.10. Screen Saver Password

Password is required when Screen Saver Password is enabled. The Screen Saver Password is determined from this section.



Fig. 73 : Screen Saver Password Bar

- 1 This touch button is pressed to set the Screen Saver Password. Screen Saver Password is determined from the keypad that appears on the screen (Fig. 74).

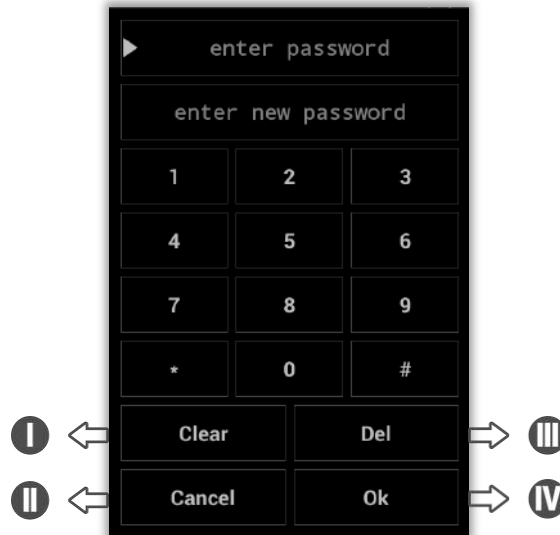

Fig. 74 : Password Number Keys

- I This touch button is pressed to clear the window.
- II The touch button is pressed to quit the number keys window.
- III This touch button is pressed to delete written.
- IV The touch button is pressed to complete the password process.

17.2.1.11. Admin Password

To enter or make changes to Settings, Theme, Connections, Diagnostic, Close and Reboot, the Admin Password is requested on the panel. The admin password is set in this section.



Fig. 75 : Admin Password Bar

- 1 This touch button is pressed to set the Admin Password. Admin Password is determined from the keypad that appears on the screen ([Fig. 74](#)).

17.2.1.12. Volume Level

Panel alarms, doorbells etc. also give an audible warning. The volume of this sound is adjusted here.

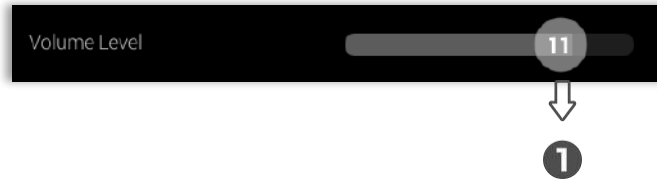

Fig. 76 : Volume Level Bar

- 1 The panel is adjusted between 0-14 volume levels. The volume of the panel is adjusted by pressing and holding this touch button right-left and sliding it. The volume level on which the touch button is set is displayed.

17.2.2. Info

Version information such as Firmware Version, App version etc. and touch panel information can be accessed from this section.

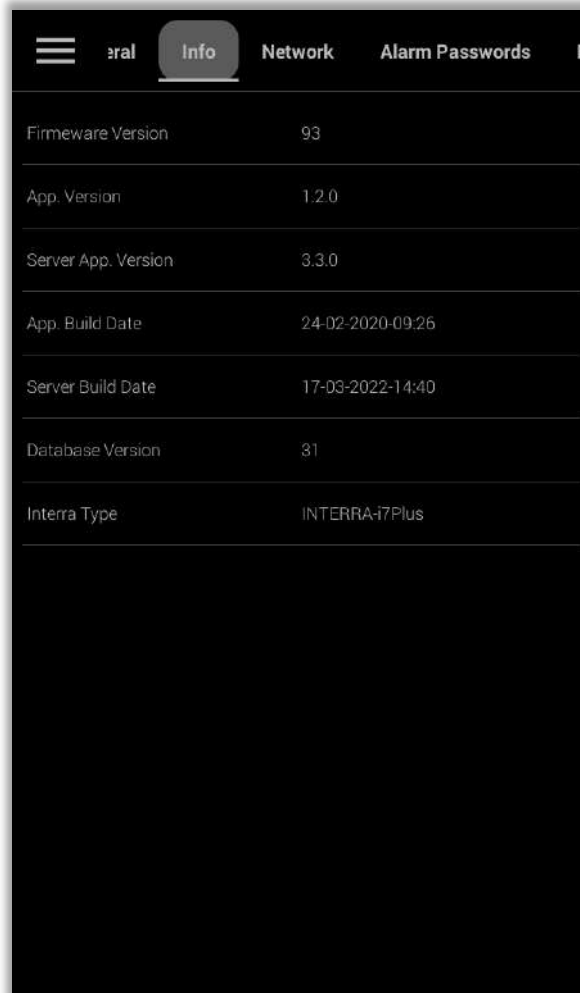

Fig. 77 : Info Section

17.2.3. Network

Local Info and Server Info such as MAC Address, IP address, Netmask etc. can be accessed from this section.

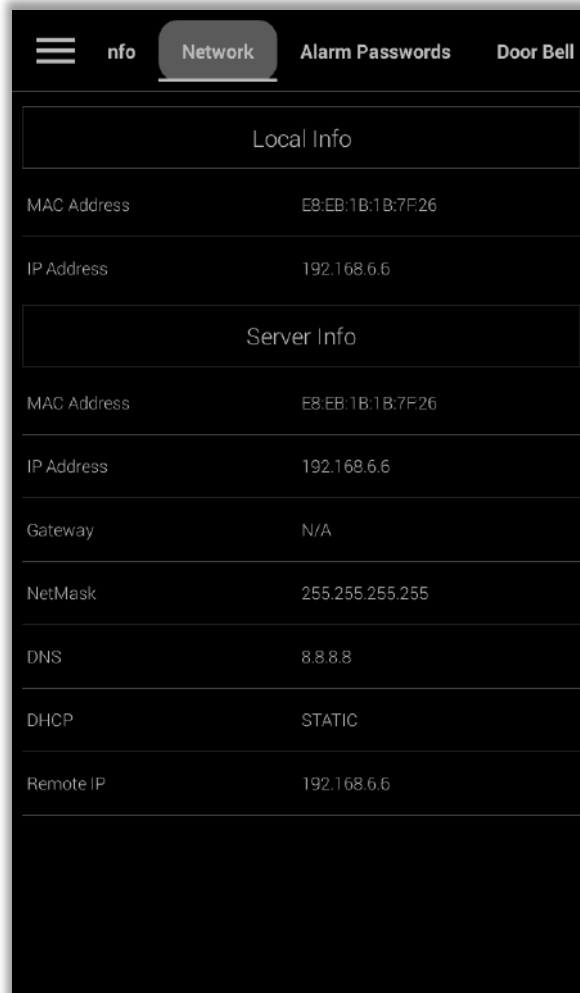

Fig. 78 : Network Section

17.2.4. Alarm Passwords

Defined Alarms are listed here. Passwords of alarms are changed here.

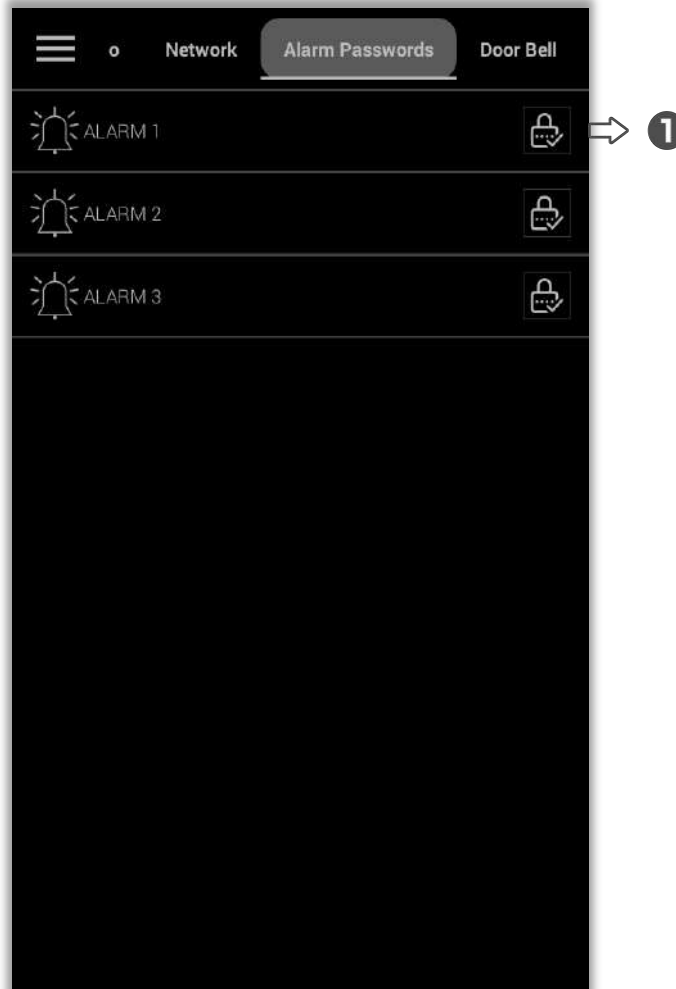

Fig. 79 : Alarm Passwords Section

- 1 By pressing this touch button, the number window opens to change the password of the selected alarm. To change the alarm password, it is necessary to enter the existing administrator password.

17.2.5. Door Bell

Selected doorbells are set in this section. After the settings are made, they are saved to the Save button.

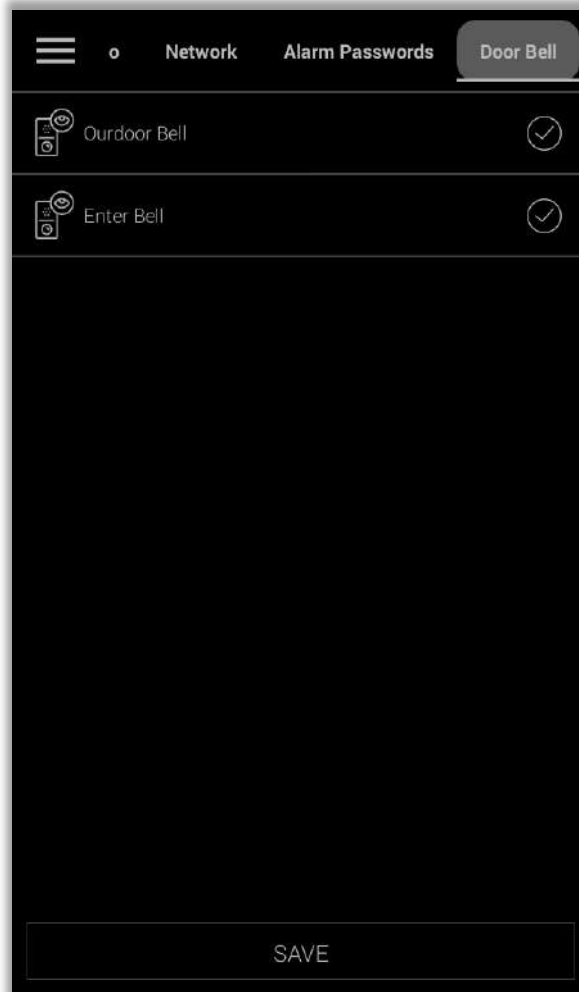

Fig. 80 : Door Bell Section

17.3. Theme

Here the theme of the i7+ Touch Panel is set. This part is entered with a password.



Fig. 81 : Theme Section

- 1** This touch button is used to return to the home page.
- 2** This touch button is used to open theme list.
- 3** This touch button is used to delete the selected theme.

17.4. Connections

From this section, registered persons can be reached. A password is entered to reach this section. The information of individuals can be shared with QR codes. Information about individuals can also be accessed from here. A new person can be added from here. Existing contacts can also be deleted from here.

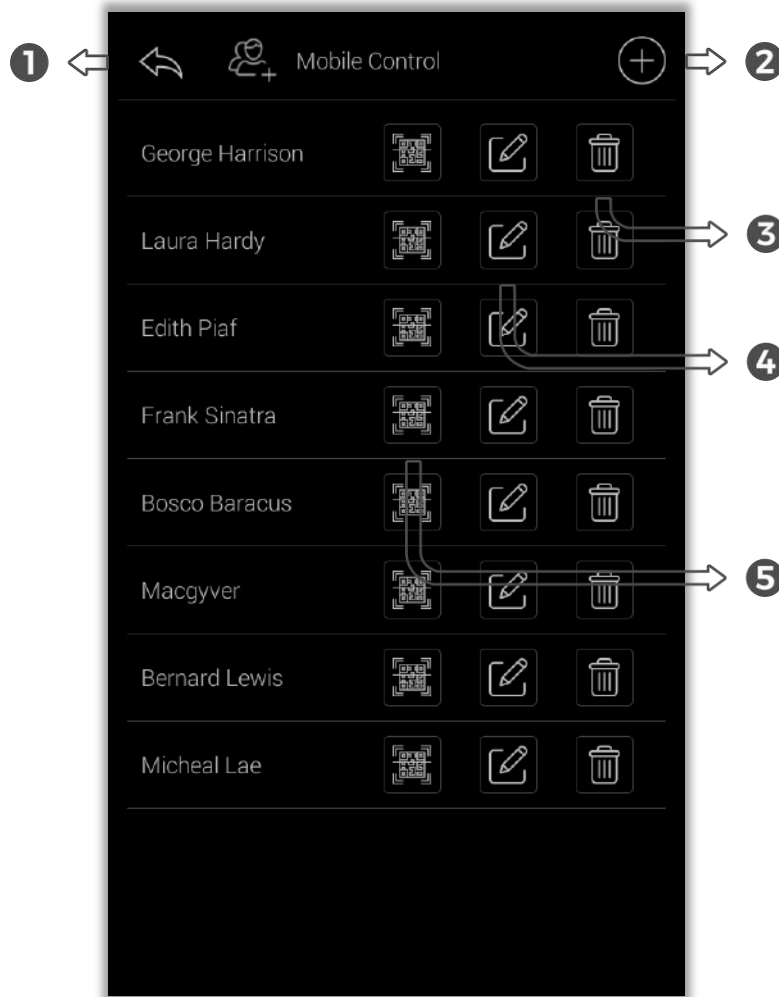

Fig. 82 : Connections - Mobile Control

1 This touch button is used to return to the home page.

2 This touch button is used to add a new person.

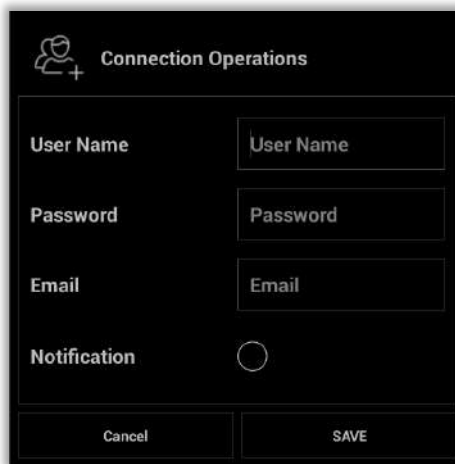

Fig. 83 : Connections – Add a new person

3 This touch button is used to delete the selected person.

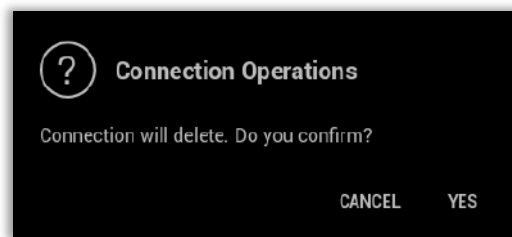

Fig. 84 : Connections - Delete

4 This touch button is used to show the selected person's QR Code.



Fig. 85 : Connections - QR Code

5 This touch button is used to show the selected person's info.

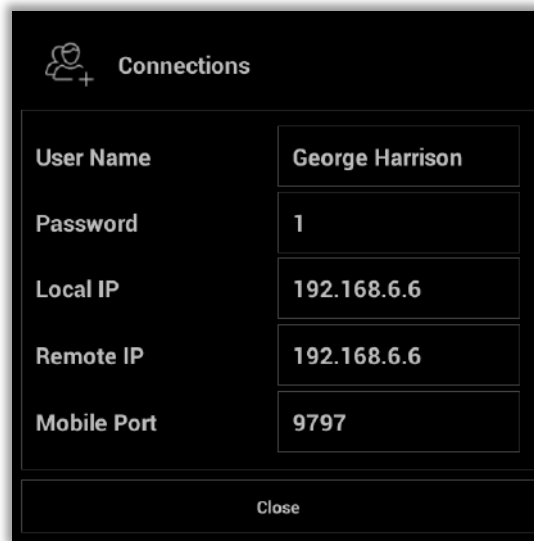

Fig. 86 : Connections - Info

17.5. About

Here you can find information about Interra.

17.6. Help

Here you can find the User Manual.



Fig. 87 : Help - User Manual

17.7. Diagnostic

It is not recommended to enter this section except authorized persons.

17.8. Close

By entering the password, the touch panel is closed.

17.9. Reboot

By entering the password, the touch panel is restarted.

CONTACT INFORMATION

THE INTERRA WEBSITE

Interra provides documentation support via our web site www.interratechnology.com. This website is used as a means to make files and information easily available to customers. Accessible by using your favourite Internet browser, the website contains the following information:

- Information about our products and projects.
- Overview of Interra company and values.
- Product Support: Datasheets, product manuals, application descriptions, latest software releases, ETS databases and archived software.

EUROPE, Turkey

Interra

Cumhuriyet mah. Kartal cad. Simkan Plaza No:95/1
Kartal/Istanbul

Tel: +90 (216) 326 26 40 Fax: +90 (216) 324 25 03

Web adress: <http://www.interratechnology.com>