

Residence Type Outdoor Stainless Intercom Unit



Product Code	ITR650-0003
Power Supply	12 V, PoE
Power Consumption	3 W (Standby Power) , 10 W (Rated Power)
Communication	TCP/IP, SIP, VOIP, RTSP
Operating System	Android 4.4.2
CPU	Quad Core 1.3 GHz
Memory	512 MB SD Ram, 8 GB Flash, 32 GB Micro SD Card
Keypad	Piezoelectric Keypad
Reader	100,000 IC/ID Cards
Door Relay Control Method	DTMF, HTTP, Key Code, IC/ID Card, Face recognition
Facial Recognition	10,000 different face recognition
Video Codec	H.264
Audio Codec	G.711, G.729
Camera	1 MP CMOS
Night Vision	LED Night Vision
Type of Protection	IP 65
Temperature Range	Operation (-5°C...55°C), Storage (-10°C...70°C)
Maximum Air Humidity	< 90 RH
Material	Aluminum Alloy
Colour	Light Grey and Black
Dimensions	Product : 158 x 380 x 54.5 mm (W x H x D) Mount Box: 142 x 358 x 59.5 mm (W x H x D)
Configuration	via Webpage

DESCRIPTION

ITR650-0003 is an Outdoor Intercom Unit with Android OS that is mainly used for making interacting with the related indoor intercom unit such as an indoor monitor. It allows you to easily monitor an entrance door or gate and gives you the confidence that your home has more security. Users can communicate with visitors via audio and video calls, and unlock the door if they need. Besides, users can use IC/ID cards to unlock the door, too.

GENERAL FEATURES

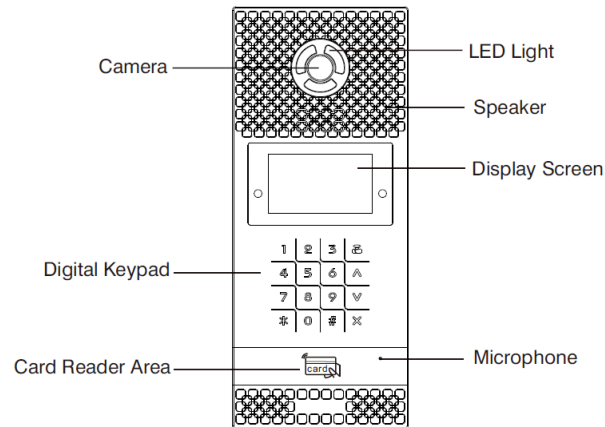

DIMENSIONS (mm)

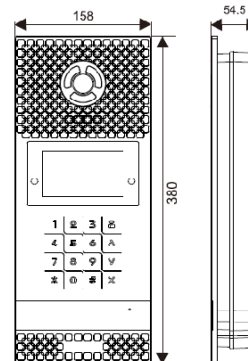

FUNCTIONS

ITR650-0003 is an Outdoor Panel Unit with that mainly used for make interacting between the related indoor intercom unit. ITR650-0003 product features are described below :

- A video intercom with an indoor monitor and management centre.
- Door opening can be done with a password, IC / ID card and face recognition.
- It can register IC/ID card information on the outdoor panel and store up to 100,000 IC/ID cards (ID card is optional).
- Support Exit button unlocking and door magnetic detection.
- Face recognition with an infrared supported night vision camera.

INSTALLATION

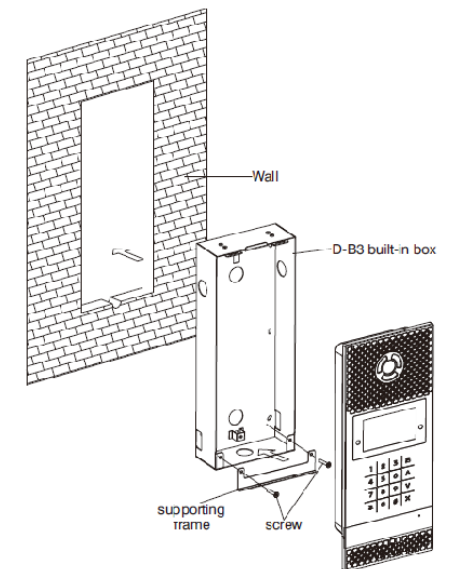

- ⚠** When mounting the built-in box, do not fix the frame into the wall. The supporting frame should be in parallel with the wall.

CONNECTION DIAGRAM & FEATURES

The following figure, shows a proper location of the installation :

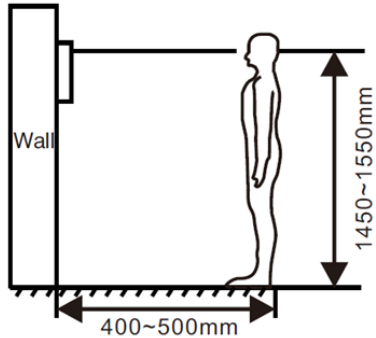

! During the installation, the camera should be 1450-1550 mm above the ground. The camera tether for photographing the human face should be the top priority.

System Diagram:

The following figures shows the connectors of the ITR650-0001.

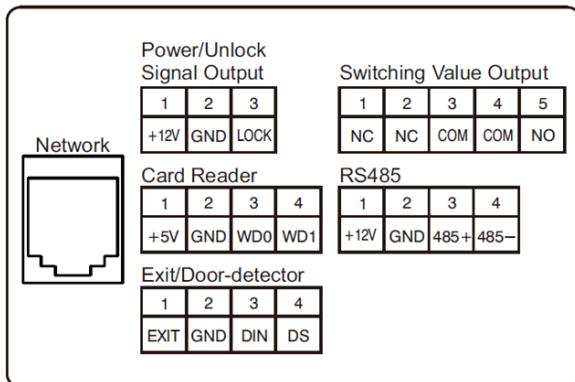

Card Reader Interface:

The interface can be connected to one IC/ID card reader or be used for reading the information of the built-in card reader. It can output the power 5 V/100 mA. When the card reader does not have the power from the interface, a wire connection of +5 V is not required:

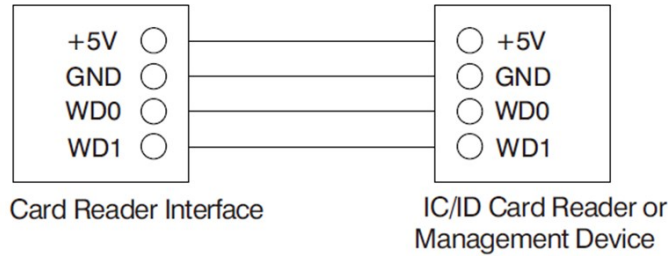

Switching Value Output:

Connect to the lock module (independent power supply is necessary for the lock).

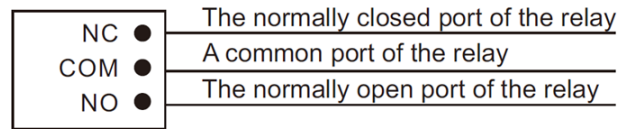

Switching Value Output

Exit Button/Door Magnetic Switch:

Connect with Exit button and door magnetic switch; DIN is reserved terminal, please don't connect it.

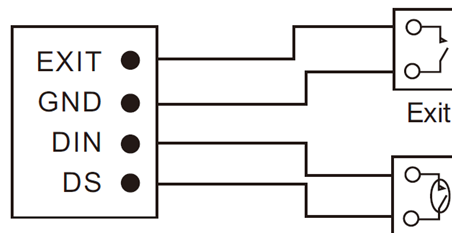

Exit/Door-detector

Door-detector Sense Switch

RS-485:

Connect with RS-485 device; RS-485 interface can output 12 V / 100 mA power supply. If RS-485 equipment to be connected does not require the power supply, no need to connect +12 V.

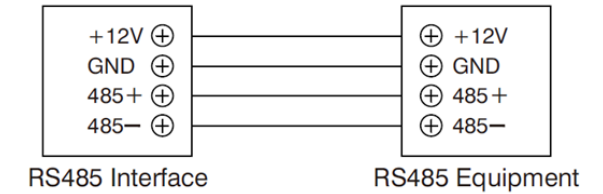

Network:

Connect to the management center, indoor monitor or another network device through a network switch.

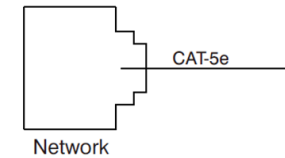

TROUBLESHOOTING

Some common failures and troubleshooting methods are listed for your reference. In case of failure which cannot be repaired, do not disassemble or repair the product by yourself. Please contact the after-sales technical service department.

- When setting the outdoor panel, please make sure building No. and unit No. of the outdoor panel are the same as the ones of the indoor monitor.
- Please check whether the network is connected.
- Please check if there are any security settings for the network.